



GROOVEBOX MC-505

Owner's Manual

Before using this unit, carefully read the sections entitled: "IMPORTANT SAFETY INSTRUCTIONS" (Owner's Manual, p. 2), "USING THE UNIT SAFELY" (Owner's Manual, p. 3), and "IMPORTANT NOTES" (Owner's Manual, p. 13). These sections provide important information concerning the proper operation of the unit. Additionally, in order to feel assured that you have gained a good grasp of every feature provided by your new unit, *** should be read in its entirety. The manual should be saved and kept on hand as a convenient reference.

This owner's manual consists of the following 16 chapters and supplementary information. Before you read this manual, you should read through the Quick Start manual so you're familiar with the basic operation of the unit.

Chapter 1	An Overview of the MC-505	1
	This chapter explains how the MC-505's sound generator and sequencer are organized, and explains the basic operation. By reading this chapter, you can gain an overall understanding of the MC-505.	
Chapter 2	Playing Patterns	2
	This chapter explains how to play patterns, and how to use functions such as Real-Time Transpose, Mute, and Part Mixer. Be sure to read this chapter.	
Chapter 3	Creating Original Sounds (Patch Edit/Rhythm Edit)	3
	This chapter explains the parameters that modify the sound. Read this chapter so you better understand how to use the knobs to control the sound when creating your own sounds.	
Chapter 4	Applying Effects to the Sound (Effects)	4
	This chapter explains the various effect types and how to use them. Read this chapter when you wish to use effects.	
Chapter 5	Pressing Chords to Produce Arpeggios (Arpeggiator)	5
	This chapter explains how to set and use the arpeggiator. Read this chapter when you wish to use the arpeggiator.	
Chapter 6	Using the Keyboard Pads to Play Phrases (RPS)	6
	This chapter explains how to use the RPS function and how to assign your own phrases. Read this chapter when you wish to use the RPS function.	
Chapter 7	Changing the Groove of a Pattern (Play Quantize)	7
	This chapter explains how to set and use Play Quantize. Read this chapter when you wish to use the Play Quantize function.	
Chapter 8	Combining Phrases to Create a Different Pattern (MEGAMIX)	8
	This chapter explains details of using MEGAMIX to combine phrases. Read this chapter when you wish to use MEGAMIX to create patterns.	
Chapter 9	Using the DBeam Controller to Apply Various Effects	9
	This chapter explains the details of using the DBeam controller. Read this chapter when you wish to use the DBeam controller.	
Chapter 10	Recording Patterns	10
	This chapter explains how to record patterns, and how to modify the musical data that has been recorded. Read this chapter when you wish to record patterns.	
Chapter 11	Editing Patterns (Pattern Edit)	11
	This chapter explains how to edit patterns. Read this chapter as necessary.	
Chapter 12	Playing and Recording Songs	12
	This chapter explains the details of playing and recording songs. Be sure to read this chapter so you better understand how to work with songs.	
Chapter 13	Editing Songs (Song Edit)	13
	This chapter explains how to edit songs. Read this chapter as necessary.	
Chapter 14	Using Memory Cards	14
	Here you can learn how to use memory cards to back up your data, and how to make copies of a card. Be sure to read this chapter before using memory cards.	
Chapter 15	Configuration (System)	15
	This chapter explains settings that determine the overall configuration for your MC-505, such as its tuning and synchronization preferences. Read this chapter as necessary.	
Chapter 16	Advanced Applications	16
	This chapter explains how the MC-505 can be used with external MIDI equipment, and gives tips for creating sounds and performing. Read this chapter when you are looking for ways to get more out of your MC-505.	
	Supplementary Information	
	Consult this chapter when the MC-505 does not function as you expect, or if an error message is displayed. This chapter also contains information such as parameter lists and the MIDI implementation.	

Copyright © 1997 ROLAND CORPORATION

All rights reserved. No part of this publication may be reproduced in any form without the written permission of ROLAND CORPORATION.



USING THE UNIT SAFELY

INSTRUCTIONS FOR THE PREVENTION OF FIRE, ELECTRIC SHOCK, OR INJURY TO PERSONS

About ⚠ WARNING and ⚠ CAUTION Notices







⚠ WARNING	Used for instructions intended to alert the user to the risk of death or severe injury should the unit be used improperly.
⚠ CAUTION	Used for instructions intended to alert the user to the risk of injury or material damage should the unit be used improperly. * Material damage refers to damage or other adverse effects caused with respect to the home and all its furnishings, as well to domestic animals or pets.

About the Symbols

	The ⚠ symbol alerts the user to important instructions or warnings. The specific meaning of the symbol is determined by the design contained within the triangle. In the case of the symbol at left, it is used for general cautions, warnings, or alerts to danger.
	The ⚡ symbol alerts the user to items that must never be carried out (are forbidden). The specific thing that must not be done is indicated by the design contained within the circle. In the case of the symbol at left, it means that the unit must never be disassembled.
	The ● symbol alerts the user to things that must be carried out. The specific thing that must be done is indicated by the design contained within the circle. In the case of the symbol at left, it means that the power-cord plug must be unplugged from the outlet.

ALWAYS OBSERVE THE FOLLOWING







⚠ WARNING

- Before using this unit, make sure to read the instructions below, and the Owner's Manual. 
- Do not open or perform any internal modifications on the unit. 
- Make sure you always have the unit placed so it is level and sure to remain stable. Never place it on stands that could wobble, or on inclined surfaces. 
- Avoid damaging the power cord. Do not bend it excessively, step on it, place heavy objects on it, etc. A damaged cord can easily become a shock or fire hazard. Never use a power cord after it has been damaged. 
- In households with small children, an adult should provide supervision until the child is capable of following all the rules essential for the safe operation of the unit. 
- Protect the unit from strong impact. (Do not drop it!) 
- Do not force the unit's power-supply cord to share an outlet with an unreasonable number of other devices. Be especially careful when using extension cords—the total power used by all devices you have connected to the extension cord's outlet must never exceed the power rating (watts/amperes) for the extension cord. Excessive loads can cause the insulation on the cord to heat up and eventually melt through. 

⚠ WARNING

- Before using the unit in a foreign country, consult with your retailer, the nearest Roland Service Center, or an authorized Roland distributor, as listed on the "Information" page. 

⚠ CAUTION

- Always grasp only the plug on the power-supply cord when plugging into, or unplugging from, an outlet or this unit. 
- Try to prevent cords and cables from becoming entangled. Also, all cords and cables should be placed so they are out of the reach of children. 
- Never climb on top of, nor place heavy objects on the unit. 
- Never handle the power cord or its plugs with wet hands when plugging into, or unplugging from, an outlet or this unit. 
- Before moving the unit, disconnect the power plug from the outlet, and pull out all cords from external devices. 
- Before cleaning the unit, turn off the power and unplug the power cord from the outlet (Quick Start, p. 5). 
- Whenever you suspect the possibility of lightning in your area, pull the plug on the power cord out of the outlet. 

Contents

Main Features	9
----------------------------	----------

Front and Rear Panels.....	10
-----------------------------------	-----------

Important Notes.....	13
-----------------------------	-----------

Chapter 1. an Overview of the MC-505 14

How the MC-505 Is Organized	14	About Memory	16
About the Sound Generator.....	14	Basic Operation	17
About the Sequencer	16		

Chapter 2. Playing Patterns 19

Playing Patterns.....	19	Adjusting the Pitch of Each Part (Part Key Shift)	25
Viewing the Number of Measures in a Pattern.....	20	Specifying the Output Destination for Musical Data (Sequencer Output Assign)	25
Adjusting the Tempo	20	Saving Patterns You've Modified (Pattern Write)	26
Using the VALUE Dial to Adjust the Tempo	20	Copying and Initializing Settings.....	27
Pressing a Button to Modify the Tempo (Tap Tempo)	20	Using the Knobs to Modify the Sound During Playback (Real-Time Modify)	28
Muting Patterns.....	21	Modifying the Sound of an Entire Patch.....	28
Muting a Part (Part Mute)	21	Modifying the Sound of an Individual Tone.....	28
Muting Individual Rhythm Tones in the Rhythm Part (Rhythm Mute).....	21	Modifying the Sound for an Individual Rhythm Group.....	29
Transposing During Playback (Real-Time Transpose)	22	Returning a Pattern to Its Original State During Playback	29
Using the VALUE Dial or [INC] [DEC].....	22	Ensuring Correct Playback from the Middle of a Pattern (MIDI Update).....	30
Using the Keyboard Pads	22	Selecting Patterns from the Keyboard Pads (Pattern Set)	31
Using the Keyboard Pads to Play Sounds	22	Using a Pattern Set to Select a Pattern.....	31
Shifting the Keyboard Range in One-Octave Steps (Octave Shift).....	23	Registering the Patterns to Be Called	31
Selecting Sounds (Patch).....	23	Saving a Pattern Set That Was Modified (Pattern Set	
Using the Part Mixer to Modify Pattern Settings	24		
Adjusting the Volume of Each Part (Part Level).....	24		
Adjusting the Pan of Each Part (Part Pan)	24		

Creating an Original Patch	33
Sound-Editing Procedure	33
Changing the Basic Waveform of the Sound (Wave/FXM)	34
Selecting the Basic Waveform (Wave Select).....	34
Making More Detailed Settings.....	35
Modifying the Pitch (Pitch)	36
Approximate Adjustments to the Pitch (Coarse Tune).....	36
Fine Adjustments to the Pitch (Fine Tune)	36
Making More Detailed Settings.....	36
Making the Pitch Change Over Time (Pitch Envelope)	37
Pitch Envelope Settings	37
Specifying the Envelope Depth (Pitch Envelope Depth).....	38
Making More Detailed Settings.....	38
Modifying the Brightness of the Sound	

(Filter)	40
Selecting the Type of Filter (Filter Type).....	40
Brightening the Sound (Cutoff Frequency)	40
Adding a Distinctive Character to the Sound (Resonance).....	41
Making More Detailed Settings.....	42
Making the Brightness Change Over Time (Filter Envelope)	43
Filter Envelope Settings	43
Specifying the Depth of the Envelope (Filter Envelope Depth).....	43
Making More Detailed Settings.....	44
Adjusting the Volume and Pan (Amplifier)	45
Adjusting the Volume of Each Tone (Tone Level).....	45
Adjusting the Pan for Each Tone (Tone Pan)	46
Causing Pan to Change Randomly (Random Pan Switch).....	46
Making More Detailed Settings.....	46
Creating Time-Variable Change in Volume (Amplifier Envelope)	48
Amplifier Envelope Settings	48

Making More Detailed Settings.....	49
Applying Cyclic Changes to the Sound (LFO)	50
Selecting the Waveform That Will Modulate the Sound (LFO1 Waveform).....	50
Adjusting the Speed of Modulation (LFO1 Rate)	51
Adjusting the Depth of Modulation (LFO1 Depth).....	51
Making More Detailed Settings.....	52
Common Settings	54
Changing How Tones Are Combined and Played (Common).....	54
Smoothly Changing the Pitch (Portamento).....	57
Playing Monophonically (Solo Switch).....	58
Making More Detailed Settings (SOLO/PORTA Section)	58
Specifying the Parameters That Will Be Modified by Each Controller (Control).....	59
Adjusting the Range of Pitch Bend (Bend Range)	60
Control 1/2/3/4 (Control Destination 1/2/3/4)	60
Ctrl 1/2/3/4 Depth (Control 1/2/3/4 Depth)	60
Saving Patches You've Created (Patch Write) ...	61
Copying and Initializing Settings.....	62
Creating an Original Rhythm Set	63
Creating the Sounds	63
Specifying the Basic Waveform of the Sound and How It Will Sound (Wave)	63
Selecting the Basic Waveform (Wave Select).....	63
Making More Detailed Settings.....	64
Changing the Pitch of the Sound (Pitch).....	64
Approximate Pitch Adjustments (Coarse Tune).....	64
Fine Pitch Adjustments (Fine Tune)	65
Making More Detailed Settings.....	65

Making the Pitch Change Over Time (Pitch Envelope)	66
Pitch Envelope Settings	66
Specifying the Envelope Depth (Pitch Envelope Depth)...	66
Making More Detailed Settings.....	66
Modifying the Brightness of the Sound (Filter)....	68
Selecting the Type of Filter (Filter Type).....	68
Brightening the Sound (Cutoff Frequency)	68
Adding a Distinctive Character to the Sound (Resonance).....	68
Making More Detailed Settings.....	69
Making the Brightness Change Over Time (Filter Envelope)	70
Filter Envelope Settings	70
Specifying the Depth of the Envelope (Filter Envelope Depth).....	70
Making More Detailed Settings.....	70
Adjusting the Volume and Pan (Amplifier)	72
Adjusting the Volume of Each Rhythm Tone (Rhythm Tone Level)	72
Adjusting the Pan for Each Rhythm Tone (Rhythm Tone Pan).....	72
Causing Pan to Change Randomly (Random Pan Switch)	72
Making More Detailed Settings.....	73
Creating Time-Varying Change in Volume (Amplifier Envelope)	74
Amplifier Envelope Settings	74
Making More Detailed Settings.....	74
Adjusting the Range of Pitch Bend (Bend Range)	75
Adjusting the Effects/Specifying the Output	

Saving Rhythm Sets You've Created (Rhythm Set Write)	77
Copying and Initializing Settings.....	78

Adding Reverberation to the Sound (Reverb)	79
Selecting the Type (Reverb Type)	79
Adjusting the Length of Reverberation (Reverb Time).80	
Adjusting the Tone of the Reverberation (HF Damp)...	80
Adjusting the Overall Reverb Volume (Reverb Level) .80	
Adjusting the Reverb Volume for Each Part (Part Reverb Level).....	80
Applying Reverb to the EFX Sound (EFX-> Reverb Level).....	81
Making More Detailed Settings.....	81
Adding an Echo to the Sound (Delay).....	82
Selecting the Type (Delay Type).....	82
Adjusting the Delay Interval (Delay Time)	83
Adjusting the Number of Repeats (Feedback Level)	83
Adjusting the Overall Delay Volume (Delay Level)	84
Adjusts the Delay Volume for Each Part (Part Delay Level).....	84
Applying Delay to the EFX Sound (EFX->Delay Level)....	84
Making More Detailed Settings.....	85
Applying Various Effects to the Sound (EFX).....	86

Selecting the Type (EFX Type).....86	Distortion (Distort the Sound Severely).....90
4 Band EQ (Modify the Tone).....87	Lo-Fi (Simulate a “Lo-Fidelity” Sound)90
Spectrum (Add Character to the Sound).....88	Noise Generator (Add Various Types of Noise).....91
Enhancer (Add Sparkle to the Sound).....89	Radio Tuning (Simulate a Radio Being Tuned)92
Overdrive (Distort the Sound Mildly).....89	Phonograph (Simulates an Old Record)92

Limiter (Smooth Out Irregularities in Volume)93	Phaser (Modulate the Sound)95
Slicer (Apply Successive Cuts to the Sound).....94	Chorus (Add Spaciousness and Depth to the Sound)...96
Tremolo (Cyclic Changes in Volume).....95	Space-D (Add Transparent Depth)97

Flanger (Add Metallic Resonance to the Sound)98	Reverb (Add Reverberation).....103
Step Flanger (Add Metallic Resonance to the Sound	Gated Reverb (Sharply Cut the Reverberation)103
While Changing the Pitch in Steps)99	Applying EFX / Specifying the Output Destination for
Short Delay (Add Echoes to the Sound).....100	Each Part (Part EFX / Output Assign)104
Auto Pan (Automatically Move the Stereo Location) .101	
Feedback Pitch Shifter (Skew the Pitch).....102	

Chapter 5. Pressing Chords to Produce Arpeggios (Arpeggiator) .. 105

Playing an Arpeggio 105	Selecting the Arpeggio Style (Arpeggio Style).....106
Creating an Arpeggio Pattern 105	Adding Expression to the Arpeggio (Accent Rate)106

Changing the Pitch Range of the Arpeggio (Octave	
Range).....106	
Making More Detailed Settings.....107	
Saving Arpeggio Settings That You Have Modified	
(Arpeggio Write) 108	

Using the Keyboard Pads to Play Back Phrases ..109
Assigning a Phrase to a Keyboard Pad 110
Making Settings for Each Phrase 111
Using the Part Mixer to Modify Settings.....111
Changing the Patch of Each RPS Part.....111
Saving the Phrases You Assigned (RPS Set Write) 112

Chapter 7. Changing the Groove of a Pattern (Play Quantize)..... 113

Selecting Parts to Use with Play Quantize 113	Selecting the Template.....115
Correcting Inaccuracies in the Rhythm	Applying Groove Quantize.....117
(Grid Quantize) 113	
Specifying the Unit (Resolution)113	
Applying Grid Quantize.....114	
Giving Swing to the Rhythm (Shuffle Quantize) 114	
Specifying the Unit (Resolution)114	
Applying Shuffle Quantize115	
Giving a Groove to the Rhythm	
(Groove Quantize) 115	

Exchanging Phrases119
 Selecting a Distant Pattern.....120

Chapter 9. Using the DBeam Controller to Apply Various Effects ..121

Using the DBeam Controller.....121
How Each Type Will Function.....121
 01:Modulation-A (Modulation All).....121
 02:Modulation-S (Modulation Single).....122
 03:Pitch Bend-A (Pitch Bend All).....122
 04:Pitch Bend-S (Pitch Bend Single).....122
 05:Cut+Reso1-A (Cutoff + Resonance 1 All).....122
 06:Cut+Reso1-S (Cutoff + Resonance 1 Single).....122
 07:Cut+Reso2-A (Cutoff + Resonance 2 All).....122
 08:Cut+Reso2-S (Cutoff + Resonance 2 Single).....123
 09:Cut+Reso3-A (Cutoff + Resonance 3 All).....123
 10:Cut+Reso3-S (Cutoff + Resonance 3 Single).....123
 11:Part Pan-A (Part Pan All).....123
 12:Part Pan-S (Part Pan Single).....124

15:Key Shift-A (Key Shift All).....124
 16:Key Shift-S (Key Shift Single).....124
 17:Reverb Level.....124
 18:Delay Level.....124

20:EFX Ctrl2 (EFX Control 2).....125
 21:EFX Ctrl3 (EFX Control 3).....125
 22:Start/Stop.....125
 23:All Mute.....125
 24:Turntable.....125
 25:Arp Range (Arpeggio Range).....125

27:Adlib1 (Ad-Lib 1).....125
 28:Adlib2 (Ad-Lib 2).....126

Recording Your Playing As You Perform (Real-Time

Recording Procedure.....127
 Changing the Recording Part While You Record.....129
 Recording an Arpeggio Performance.....129
 Recording Knob Movements (Modify Data).....130
 Recording Part Mixer Movements.....130
 Recording Smoothly Across Pattern Boundaries.....131
 Recording the Mute Settings.....131
 Recording Changes in Tempo.....131
 Erasing Unwanted Data While You Record (Real-Time Erase).....132
Recording Notes One at a Time (Step Recording) .133
 Recording Procedure.....133
 Recording Notes One by One (Step Recording 1).....134
 Various Ways to Input Notes.....135
 Recording Individual Notes to Grid Locations (Step Recording 2).....136
 Various Ways to Input Notes.....139

Individually Editing Musical Data (Microscope Edit)140
 View the Musical Data That You Input.....140
 Musical Data Handled in Microscope Mode.....141
 Modifying the Value of Musical Data (Change Event)....142
 Deleting Musical Data (Delete Event).....143
 Inserting Musical Data (Insert Event).....143
 Moving Musical Data (Move Event).....143
 Hiding Unwanted Musical Data (View Filter).....144
Checking the Remaining Amount of Memory (Memory Information)144
 Temp (Temporary).....145
 User (User Memory).....145
 Card (Card Memory).....145

	Erasing Unwanted Data (Erase)	147
	Deleting Unwanted Measures (Delete Measure)...	148
	Inserting Blank Measures (Insert Measure)	149
	Transposing the Pitch (Transpose).....	150
	Modifying the Strength of Notes (Change Velocity)	150
Copying a Portion of a Pattern (Copy)		146

Shifting the Timing Slightly (Shift Clock)	151
Thinning Out Unneeded Data (Data Thin).....	152
Using Play Quantize Settings to Modify a Pattern (Edit Quantize)	153
Converting the Note Timing of a Pattern (Reclock)	153
Playing Back a Song	154
Recording a Song	155
Saving a Song That You Recorded (Song Write)...	155

Copying a Song (Song Copy)	157
Deleting Unwanted Patterns from a Song (Delete Pattern)	158
Inserting a Pattern (Insert Pattern).....	158

High-performance synthesizer sound generator

A high-performance synthesizer module is featured for sound generation. A rich array of parameters, including sharp filters and standard ADSR envelopes can be modified from panel knobs and sliders to create sounds with the same hands-on immediacy as on vintage analog synthesizers. The MC-505 will also function as an 8-part multitimbral sound module.

Cutting-edge patterns that lead the scene

The MC-505 contains 248 high-quality preset patterns for immediate use and 466 RPS patterns. Since the patterns cover a wide range, from techno to reggae, this instrument provides everything you need for most situations.

The sounds of today

The MC-505's carefully selected 512 sounds and 26 rhythm sets are just what you need for today's dance scene, and include great sounds from vintage instruments such as the TB-303, JUNO, JUPITER and TR-808/909. From the day you purchase the MC-505, you will be enjoying cutting-edge sounds that cannot be obtained on any other synthesizer.

Original sounds that you create can also be stored in internal memory for immediate access.

Three sophisticated digital effect units

High-performance DSP (digital signal processing) technology provides you with a wide range of effects. Three multi-effect units are provided: Reverb adds reverberation, Delay adds echo-like effects, and EFX (general-purpose multi-effect unit) provides 24 types of effect that have been optimized for dance music.

Six outputs for flexibility

In addition to the stereo outputs, the MC-505 provides two sets of stereo direct outputs. This lets you apply external effects to specific rhythm instruments, or to use an external mixer to perform detailed mixing.

A sequencer to help your ideas take shape

You can construct a song in real time as you play, simply by switching the playback patterns. During recording, you can switch the recording part to record non-stop.

The MC-505's internal memory by itself can contain approximately 95,000 notes (up to 200 patterns). By using a memory card (SmartMedia), the capacity can be boosted to a maximum of approximately 480,000 notes (up to 200 patterns).

MEGAMIX

The MEGAMIX function lets you replace phrases of a part in real time to create totally different patterns. Even without recording patterns yourself, your own sense of rhythm is all you need to create any number of original patterns.

Use the arpeggiator to create phrases

You can play arpeggios simply by pressing the keyboard pads. Your musical imagination and taste are all you need to create completely new phrases.

RPS (Real-Time Phrase Sequence) function

You can play back phrases simply by pressing a single keyboard pad. This has a wide variety of uses, such as adding accents during a song, or playing an entire song using just RPS.

Play Quantize changes the groove in real time

The MC-505 provides three types of play quantize: Grid, Groove and Shuffle. Simply by rotating a knob, you can produce your own "groove" in real time.

Controls for live performance

The MC-505 is designed for live performance, with features such as a mute button that lets you instantly silence the playback of a specific part or rhythm instrument, a Real-Time Transpose function that lets you transpose during pattern playback, and a part mixer that provides sliders to control all parts simultaneously. Of course, you can also move knobs during pattern playback to modify the sound in realtime, and knob movements can be transmitted as MIDI messages.

DBeam controller

The DBeam controller gives you control over a variety of effects, simply by moving your hand. In conjunction with the visual element, this can be a powerfully impressive addition to a live performance.

** The DBeam has been licensed from Interactive Light, Inc.*

Low Boost function for solid bass

The Low Boost that was so popular on the MC-303 has been redesigned so it is even more powerful. In addition to the previous features, the MC-505 now features an Octave function that generates sound one octave below the original sound, for powerful ultra-low bass.

Front and Rear Panels

Front Panel

1 VOLUME Knob

Controls the overall volume of the MC-505.

2 LOW BOOST Section

This controls the effect of the low boost section.

5 FUNC Button

This switches the function of the various knobs. When the button is blinking, the function printed in the box near each knob will be in effect.

7 DISPLAY Section

Use [INC] [DEC] or the VALUE dial to select the parameter that you wish to modify.

16 PLAY QUANTIZE Section

Modifies the groove of the pattern.

17 ARPEGGIATOR Section

Settings for playing arpeggios.

18 REVERB/DELAY/EFX Section

Gives you control over effects like reverb and delay.

19 PART MIXER Section

Use the part sliders to modify various settings for each part.

25 KEYBOARD PAD Section

Here you can select the effect of the keyboard pads, and specify how they will function when played as a keyboard.

27 WRITE Button

Press this button to save a pattern or patch, or to initialize a parameter.

28 UNDO/REDO Button

Press this button to cancel the previous operation, or to copy a parameter.

31 SHIFT Button

This button is used in conjunction with other buttons.

3 D BEAM CONTROLLER section

You can apply a variety of effects to patterns and patches simply by moving your hand.

4 MODE Section

Here you can switch the operating mode.

6 CURRENT Display

NEXT Display

LCD Display

BEAT Indicator

MIDI Indicator

SLAVE Indicator

These show various types of information.

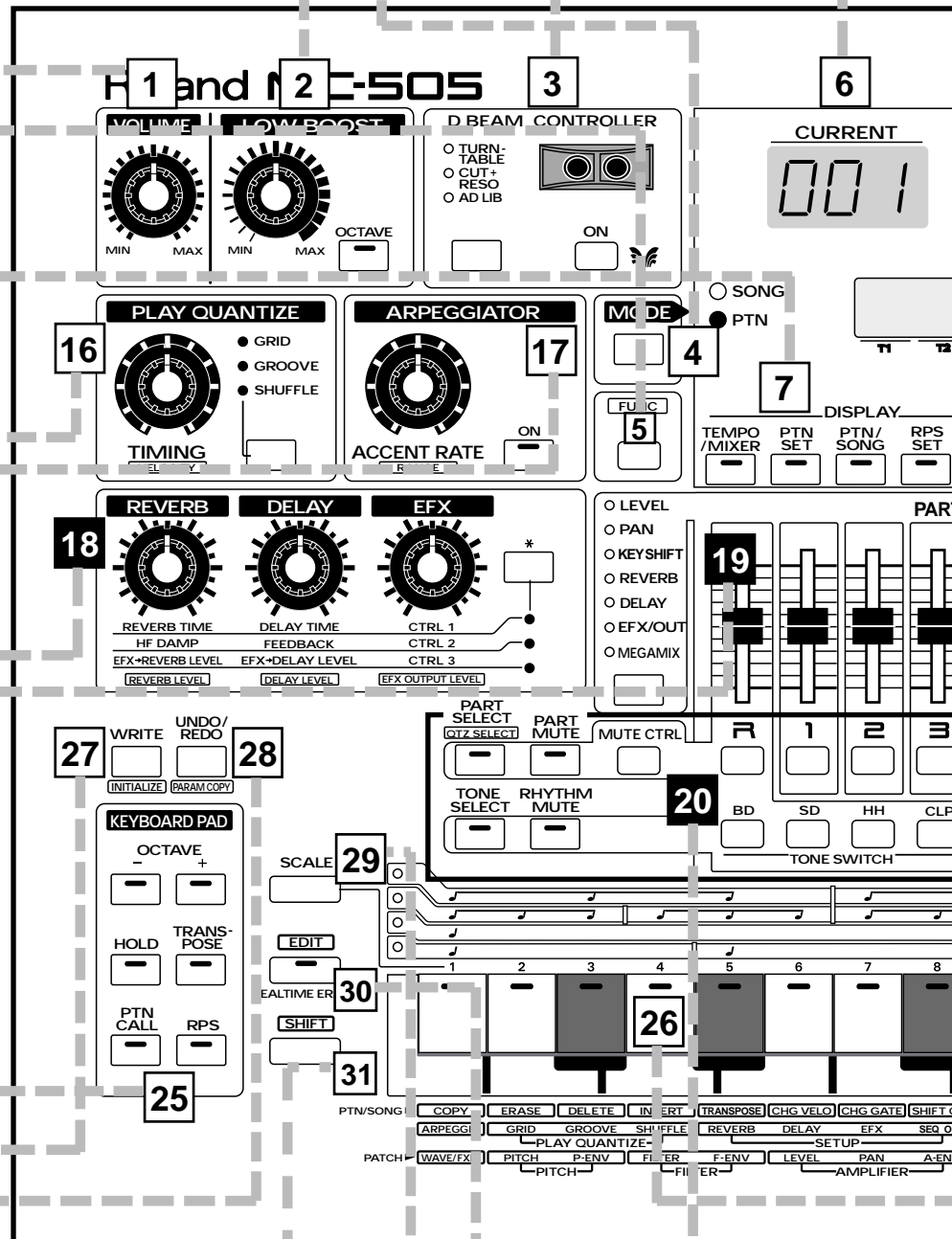

29 SCALE Button

During step recording, this button selects the note value unit.

30 EDIT Button

This button selects the editing pages for a sound or pattern.

20 PART SELECT/TONE SELECT Buttons

Use these buttons to select part/ tone/rhythm groups, and to switch muting on/off.

During recording, these buttons select velocity and gate time.

8 BANK Section
Select the bank of the pattern or patch.

9 WAVE SELECT Button
Select the waveform that will be the basis of the sound.

10 PITCH Section
Adjusts the pitch of the sound.

11 FILTER/AMPLIFIER Section
Adjusts the brightness and dynamics of the sound.

12 ENVELOPE Section
Adjusts time-varying changes in pitch, brightness and volume.

13 ENV SELECT Button
Use this button when making ENVELOPE section settings and LFO1 DEPTH settings.

14 LFO1 Section
Applies cyclic change to the sound.

15 PORTAMENTO Section
For settings such as portamento and solo, which determine how the sound will be played from the keyboard pads.

21 INC/DEC (Increment/Decrement) Buttons VALUE Dial
Use these to modify the value of a parameter.

22 PAGE</PAGE> Buttons
Use these to move between screen pages in the display. In pages where you need to supply a name, they move the cursor.

23 ENTER/EXIT Buttons
Use these buttons to execute/cancel an operation, or to exit from a setting page.

24 SEQUENCER Section
These buttons control sequencer playback and recording operations, etc.

26 KEYBOARD PADS
Use these pads to play sounds or to play back patterns or RPS. Normally, the key marked "2" will be C4.

32 TAP Button
The tempo can be adjusted by pressing this button at the desired timing.

* Movements of the knobs or buttons in sections marked by numbers on a white background can be recorded in a pattern.

Rear Panel

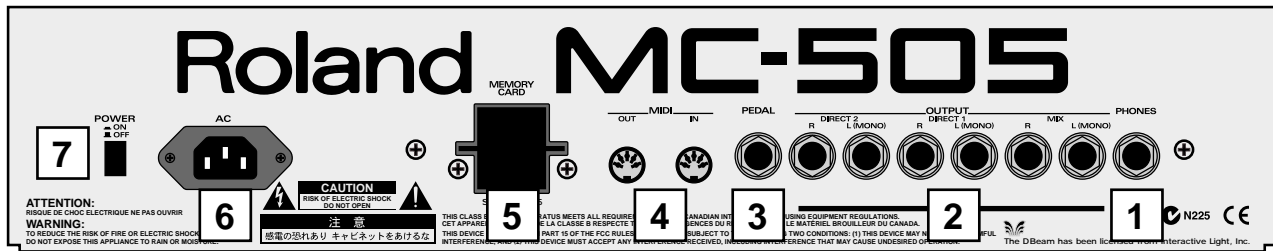

1 PHONES Jack

Accepts connection of headphones.

2 OUTPUT Jacks

MIX L (MONO), R / DIRECT1 L (MONO), R / DIRECT2 L (MONO), R

Provide output of the audio signals. Connect them to your keyboard amp, audio system, or mixer etc. Use audio cables (sold separately) to make connections.

3 PEDAL Jack

An optional pedal switch can be connected here to control a variety of functions.

4 MIDI IN/OUT Connectors

External MIDI devices can be connected here. Use MIDI cables (sold separately) to make connections.

5 MEMORY CARD Slot

An optional memory card (SmartMedia) can be inserted here.

6 AC Inlet

Connect the included power cable here.

7 POWER Switch

This switch turns the power on/off.

Important Notes

In addition to the items listed under “IMPORTANT SAFETY INSTRUCTIONS” and “USING THE UNIT SAFELY” on pages 2 and 3, please read and observe the following:

Power Supply

- Do not use this unit on the same power circuit with any device that will generate line noise (such as an electric motor or variable lighting system).
- Before connecting this unit to other devices, turn off the power to all units. This will help prevent malfunctions and/or damage to speakers or other devices.

Placement

- This device may interfere with radio and television reception. Do not use this device in the vicinity of such receivers.

Maintenance

- For everyday cleaning wipe the unit with a soft, dry cloth or one that has been slightly dampened with water. To remove stubborn dirt, use a cloth impregnated with a mild, non-abrasive detergent. Afterwards, be sure to wipe the unit thoroughly with a soft, dry cloth.
- Never use benzine, thinners, alcohol or solvents of any kind, to avoid the possibility of discoloration and/or deformation.

Additional Precautions

- Unfortunately, it may be impossible to restore the contents of data that was stored in the unit’s memory, a memory card or another MIDI device (e.g., a sequencer) once it has been lost. Roland Corporation assumes no liability concerning such loss of data.
- Use a reasonable amount of care when using the unit’s buttons, sliders, or other controls; and when using its jacks and connectors. Rough handling can lead to malfunctions.
- Never strike or apply strong pressure to the display.
- When connecting / disconnecting all cables, grasp the connector itself—never pull on the cable. This way you will avoid causing shorts, or damage to the cable’s internal elements.
- A small amount of heat will radiate from the unit during normal operation.
- To avoid disturbing your neighbors, try to keep the unit’s volume at reasonable levels. You may prefer to use headphones, so you do not need to be concerned about those around you (especially when it is late at night).
- When you need to transport the unit, package it in the box (including padding) that it came in, if possible. Otherwise, you will need to use equivalent packaging materials.
- SmartMedia is a trademark of Toshiba corporation.
- All product names mentioned in this document are trademarks or registered trademarks of their respective owners.

The sounds, phrases and patterns contained in this product are sound recordings protected by copyright. Roland hereby grants to purchasers of this product the permission to utilize the sound recordings contained in this product for the creation and recording of original musical works; provided however, the sound recordings contained in this product may not be sampled, downloaded or otherwise re-recorded, in whole or in part, for any other purpose, including but not limited to the transmission of all or any part of the sound recordings via the internet or other digital or analog means of transmission, and/or the manufacture, for sale or otherwise, of any collection of sampled sounds, phrases or patterns, on CD-ROM or equivalent means.

The sound recordings contained in this product are the original works of Roland Corporation. Roland is not responsible for the use of the sound recordings contained in this product, and assumes no liability for any infringement

of any copyright of any third party arising out of use of the sounds, phrases and patterns in this product.

Important

Please observe the following points when using the MC-505.

Various types of data required for the MC-505's operation are held in internal flash memory. If the power is turned off while data is being written to flash memory, writing will not be completed correctly, and subsequent operation can be affected.

While the following display appears, never turn off the power or remove the memory card.

Processing...
Keep Power ON !

Chapter 1. an Overview of the MC-505

A brief explanation of the MC-505's internal organization was provided in the Quick Start manual, but this chapter contains a more detailed explanation of the basic sections: the controller section, sound generating section, and the sequencer section.

How the MC-505 Is Organized

1

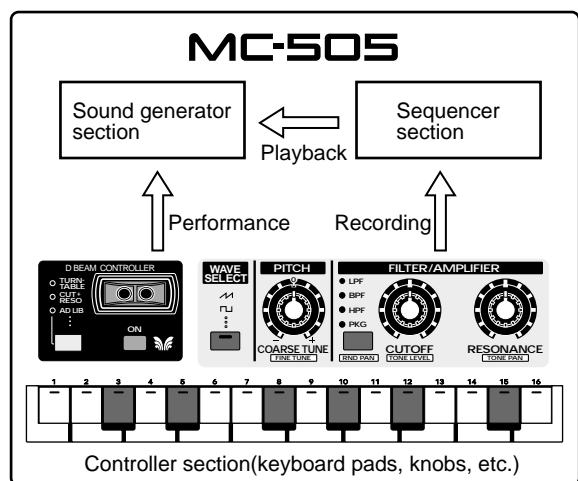

Controller

On the MC-505, the controller section includes the keyboard pads, the panel knobs and sliders, the D Beam controller, and a pedal switch connected to the rear panel. By operating these controllers, you can play or modify sounds.

Sound Generator

This is the section that produces the sound. The sound generator produces sound in response to data it receives from the MC-505's controllers and its sequencer. It can also be played by MIDI messages that arrive from an external MIDI device.

Sequencer

The sequencer section records controller operations (knob movements) as MIDI messages, and can play back the MIDI messages that were recorded. MIDI messages that have been recorded on the sequencer can also be transmitted from the MIDI OUT connector, and used to control external MIDI devices.

About the Sound Generator

Tones and Patches

"Tones" are the smallest unit of sound used by the MC-505, and one tone produces one sound. Up to four of these tones can be combined to create a "patch," which is a single sound that you play. There are two types of patches: "Preset Patches" which are already built into the MC-505, and "User Patches" which are the patches that you create.

Tones and patches are organized as illustrated below.

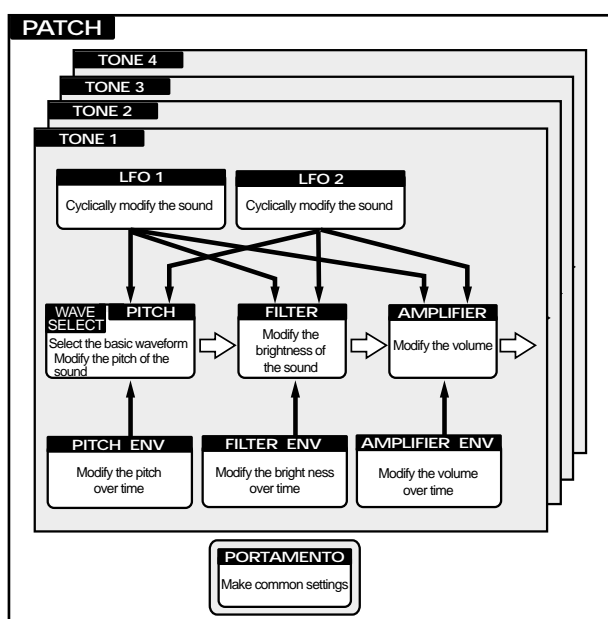

* The way in which the four tones are combined will determine how they will sound. This is determined by the Structure Type parameter.

📖 "Changing How Tones Are Combined and Played (Common)" (p. 54)

Rhythm Set

A collection of various rhythm instruments (rhythm tones) is referred to as a Rhythm Set. A different rhythm tone can be assigned to each key (note number), allowing you to use a large number of rhythm tones at once. There are two types of rhythm sets: "Preset Rhythm Sets" which are already built into the MC-505, and "User Rhythm Sets" which accommodate the rhythm sets that you create.

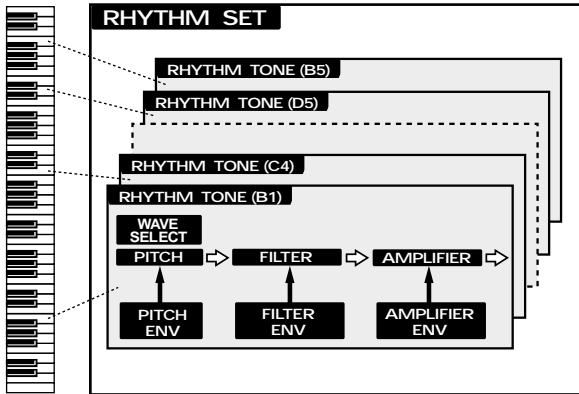

Part

You can think of "Parts" as slots into which Patches are placed. They can be thought of as being a little like musicians. You can select a patch (instrument) for each part (musician), and play multiple parts at once. The MC-505 has eight parts for pattern playback, and you can adjust the volume and pan etc. for each part.

Sound source section

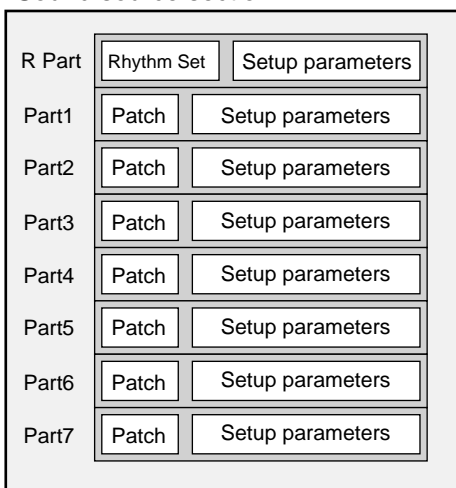

Parts 1D7

For each of these parts, you can select a patch and play melodic, bass or chordal instruments. Since it is also possible to select an individual rhythm tone, you can also use one of these parts as an auxiliary rhythm part.

Rhythm part

For this part, you can select a rhythm set and play percussion instrument sounds.

About simultaneous polyphony

The MC-505 is able to play up to 64 notes simultaneously. If the incoming musical data requests more than 64 notes simultaneously, some notes will drop out. When using patches with a long release time or when using RPS, be careful not to exceed the maximum simultaneous polyphony. The number of notes that can be sounded will actually depend not only on the number of notes being played, but also on the number of tones that are used by each patch.

For example, if you are playing a patch that uses four tones, that patch will take up four times the number of notes that are played.

If you would like to know about the polyphony settings...

- The Voice Priority parameter can be set for each patch to specify how notes will be turned off when the maximum polyphony is exceeded.

"Changing How Tones Are Combined and Played (Common)" (p. 54)

- The Voice Reserve parameter can be set to specify a minimum number of notes that will be reserved for each part.

"Specifying the Number of Notes for Each Part (Voice Reserve)" (p. 164)

About the Sequencer

The sequencer records your performance and controller operations as musical data. Playing back the sequencer will cause this recorded musical data to be sent to the sound generator, making it produce sound. In other words, the sequencer plays the instrument instead of the musician.

1

In the sense that it records and plays back a performance, a sequencer is similar to a tape recorder. However, it has unique advantages: the tempo can be modified without affecting the pitch, there is no decrease in sound quality no matter how many times you play something back, and extremely detailed edits can be made at will.

Patterns

Patterns are musical data of various genres for the sequencer to play back, and can be selected even while they play back. The data within each pattern is divided into parts, and you can record or play back each part separately, or modify the musical data inside each part. For each pattern, you can also specify things such as the patch and volume that will be used by each part.

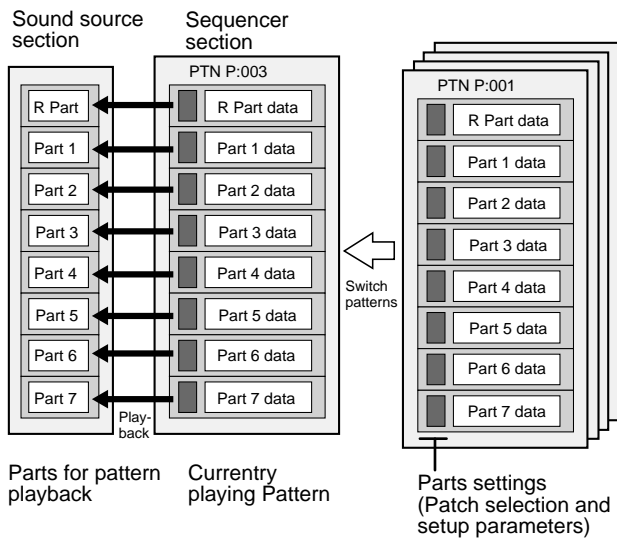

There are two types of patterns: "Preset Patterns" which are already built into the MC-505, and "User Patterns" which can contain patterns that you create.

Songs

A sequential arrangement of two or more patterns is called a "song." When you play back a song, the patterns in the song will play back in succession. A song can contain up to 50 patterns.

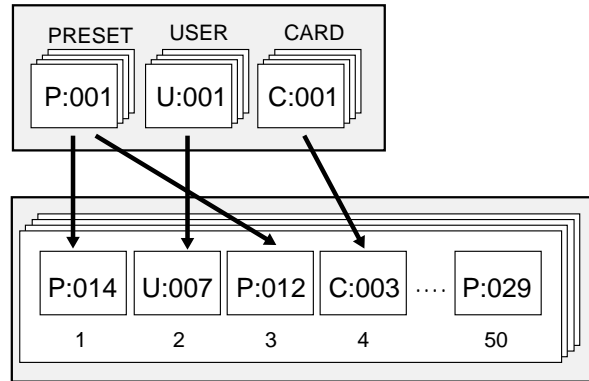

About Memory

"Memory" refers to the place where patch settings and musical data for patterns and other things are kept. The memory of the MC-505 is divided into three areas: System Memory, User Memory, and Preset Memory. There is also a "temporary area" within memory, into which data is placed when you select a patch or pattern, and the data in the temporary area is what you are actually playing and editing.

System Memory

System Memory contains settings for the system parameters that configure the MC-505. These include parameters that determine the overall operation of the sound generator or sequencer, and MIDI-related settings.

User Memory

The contents of User Memory can be overwritten, and are used to store settings or musical data that you create. User Memory stores 256 patches, 200 patterns, 50 songs, 60 RPS sets, and 30 pattern sets.

* At the factory settings, the User Patches have the same contents as Preset Memory. The User Patterns are empty.

Preset Memory

The contents of Preset Memory cannot be rewritten. Preset Memory contains 512 patches and 714 patterns.

Temporary Area (Temporary pattern)

When you play a sound or select a patch for editing, the selected patch is called into a location known as the “temporary area.”

When you edit or record a pattern, the contents of the pattern are automatically copied to U:TMP (temporary pattern), and your operations will affect this data.

Memory Card

An optional memory card can be used to store 512 User Patches and 200 User Patterns, just as in the user memory of the MC-505.

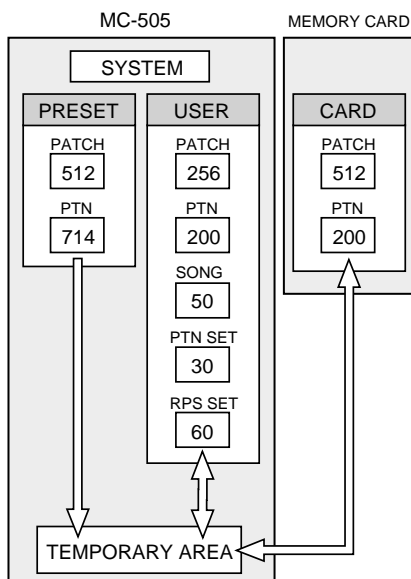

* The data in memory will be preserved even if the power is turned off, and can be recalled at any time. However, the data in the temporary area will be lost when the power is turned off.

When you modify the settings of a patch or the contents of a pattern, you are actually modifying the data that was called into the temporary area or the temporary pattern. (In other words, you are not directly modifying the data in memory.) If you wish to keep the changes that you have made to the patch or pattern, you must save the data as a user patch or user pattern.

📖 “Saving Patches You’ve Created (Patch Write)” (p. 61)

📖 “Saving Patterns You’ve Modified (Pattern Write)” (p. 26)

Basic Operation

Modifying a Value

To select a patch or pattern, or to modify a parameter value, use the VALUE dial or the INC/DEC buttons.

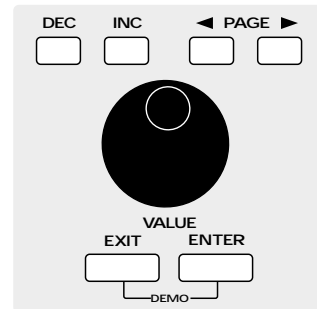

INC button/DEC button

To increase a value press [INC]. To decrease a value press [DEC].

If you continue pressing the button, the value will continue to change.

If you press one button while holding down the other button, the value will change rapidly.

If you hold down [SHIFT] and press a button, the value will change in larger steps.

VALUE dial

To increase a value, rotate the [VALUE] dial clockwise. To decrease a value, rotate the [VALUE] dial counterclockwise.

If you hold down [SHIFT] as you rotate the [VALUE] dial, the value will change in larger steps.

Canceling the Previous Operation (Undo/Redo)

The function that restores an edited musical data to its previous condition is called Undo, and the function that restore the “undone” or musical data to the edited condition is called Redo.

The MC-505 lets you use undo/redo for the following operations. This is convenient when you wish to cancel a change, or to compare your edits with the original data.

- **Pattern Edit** ⇨ “Editing Patterns (Pattern Edit)” (p. 146)
- **Song Edit** ⇨ “Editing Songs (Song Edit)” (p. 157)
- **Pattern Recording** ⇨ “Recording Patterns” (p. 127)
- **Song Recording** ⇨ “Recording a Song” (p. 155)

1. Make sure that the pattern or song select page is displayed.

2. Press [UNDO/REDO].

The following display will appear.

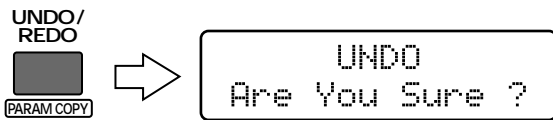

3. Press [ENTER], and your changes will be Undone, restoring the value to its unmodified state.

4. Press [UNDO/REDO] once again.

The following display will appear.



5. Press [ENTER], and your changes will be Redone, returning the value to its edited state.

** Undo/Redo operations must be done immediately after you modify the data. Once you save the modified pattern, the undo/redo operation will no longer be available. Also, if you use a different operation to make a further change to the data, it will no longer be possible to undo/redo to the change that was made first.*

When you execute an operation that modifies a large amount of data, such as during pattern editing, the following message may appear. If you are sure you will not need to revert to the original data, press [ENTER] to execute the operation. If you wish to cancel the operation, press [EXIT].

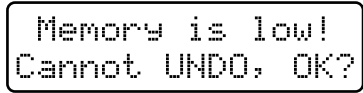

Chapter 2. Playing Patterns

Playing Patterns

1. Make sure that the PTN indicator is lit.

If it is not lit, press [MODE] to make it light (Pattern mode).

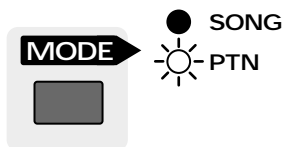

2. Press [PTN/SONG].

The indicator will light.

The display will indicate the bank, number and name of the currently selected pattern.

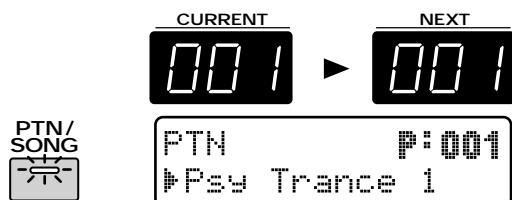

3. Press one of the buttons [PRESET]/[USER]/[CARD] to select the bank.

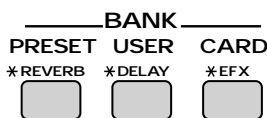

[PRESET] P: (Preset bank)

[USER] U: (User bank)

[CARD] C: (Card bank)

Each time you press the same bank button, the number will change in steps of 100.

4. Use [INC] [DEC] or the [VALUE] dial to select the number.

Range: P:001–P:714, U:001–U:200, C:001–C:200

The number and name in the display will change.

A pattern has now been selected.

* P:249–P:714 are RPS patterns. Each pattern contains one phrase.

* The card bank can be selected only if an optional memory card is inserted.

"Using Memory Cards" (p. 159)

5. Press [PLAY] and the pattern will play back.

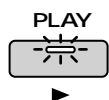

The pattern that is currently playing back is referred to as the "current pattern," and the pattern that is scheduled to play next is called the "next pattern." Immediately after a pattern plays back, the CURRENT display and the NEXT display will show the same pattern number, and that pattern will play back repeatedly.

6. Use steps 3D4 to select the next pattern.

The display will indicate the bank, number and name of the next pattern.

When you select the next pattern, the "P" at the left of the pattern name will change to "P:".

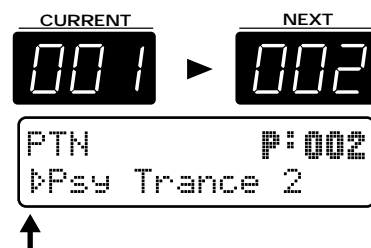

7. When the current pattern plays to the end, the next pattern will automatically be selected.

8. Press [STOP] and the pattern will stop playing.

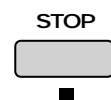

* When the pattern changes, or when it is close to repeating, the NEXT display will begin blinking to remind you of this. While this is blinking, it is not possible to select the next pattern.

* If you press [STOP] to stop playback after selecting the next pattern, the pattern that you had reserved will be canceled.

* With the factory settings, the user bank contains empty patterns that contain no musical data. Even if you select an empty pattern, it will not play back. If you specify an empty pattern as the next pattern, playback will stop the instant that the pattern changes.

2

Fast-forward and rewind

Each time you press [FWD], the pattern will advance one measure. Each time you press [BWD], the pattern will go back one measure.

If you hold down [SHIFT] and press [FWD], you will advance to the last measure. If you hold down [SHIFT] and press [BWD], you will return to the beginning.

While the pattern is stopped, you can press [STOP] to return to the beginning.

When a pattern is stopped, a decimal point will sometimes be displayed in the lower right of the NEXT display. This indicates that the pattern was stopped in the middle of the measure.



If you would like to know what kind of patterns are available...
 "Preset Pattern List" (p. 203)

Viewing the Number of Measures in a Pattern

If you wish to know the total number of measures in the current pattern, or the current playback location, use the following procedure.

1. Press [MEASURE].

While the button remains pressed, the CURRENT display will indicate the total number of measures in the pattern, and the NEXT display will indicate the playback location (measure and beat). A display as shown below indicates that "the total number of measures = 16 measures," "playback location = measure 12 beat 3"



Changing patterns instantly

By pressing PAGE [<] [>] while a pattern is playing back, you can switch immediately to the previous or next pattern. In this case the pattern will playback the optimal tempo for that pattern.

Also, if you make a new recording and create a pattern that is only one measure long, and play back this pattern, it will in some cases be impossible to use [INC] [DEC] or the [VALUE] dial to select the next pattern. In such cases, use PAGE [<] [>] to change patterns.

Adjusting the Tempo

The tempo can be adjusted freely even while a pattern is playing back.

Using the VALUE Dial to Adjust the Tempo

1. Press [TEMPO/MIXER].

The indicator will light, and the display will indicate the current tempo value.



2. Use the [VALUE] dial to modify the tempo (20.00240.0 BPM).

The tempo can be adjusted in 0.1 BPM steps. By holding down [SHIFT] and rotating the [VALUE] dial, you can adjust the tempo in 1 BPM units.

Pressing a Button to Modify the Tempo (Tap Tempo)

You can modify the tempo by the rate at which you press the TAP button.

1. At quarter-note beats, press [TAP] three or more times at the desired tempo.

The tempo will be calculated automatically, and set to the interval at which you pressed the button.

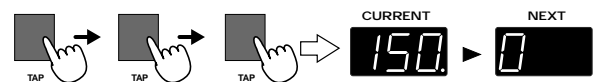

You can use the TAP button to modify the tempo even when the tempo value does not appear in the display. The BEAT indicator lets you check the tempo and time signature. The indicator will blink in red on the first beat of each measure, and in green on subsequent beats.

BPM

BPM stands for Beats Per Minute, and indicates the number of quarter notes that occur in one minute.

Standard tempo

An optimal tempo is already set for each pattern. This is called the "standard tempo."

If you select another pattern while pattern playback is stopped, the tempo will change to the standard tempo of that pattern. When you use [INC] [DEC] or the [VALUE] dial to switch to another pattern during pat-

tern playback, the tempo value of the previous pattern will be maintained.

Muting Patterns

During pattern playback, you can mute the playback of a specific part or rhythm tone.

Muting a Part (Part Mute)

1. Press [PART MUTE].

The indicator will light, and the PART button [R]- [7] indicators will show the current status of that part.



Blinking: The playback data is muted.

Lit: The playback data is not muted

Dark: There is no playback data.

2. Press the PART button of the part that you wish to mute.

The indicator of the button you pressed will begin blinking, and the playback data will be muted.

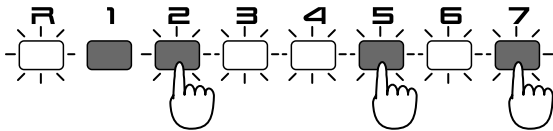

To cancel muting, press the PART button of the muted part to make the indicator light.

* The indicator will not light even if you press the PART button of a part that is dark.

* None of the preset patterns P:001–P:248 contain playback data for part 1.

You can change the mute status of each part, and save the setting in a user pattern.

☞ “Saving Patterns You’ve Modified (Pattern Write)” (p. 26)

Muting Individual Rhythm Tones in the Rhythm Part (Rhythm Mute)

You can mute the playback of specific rhythm groups in the rhythm part.

1. Press [RHYTHM MUTE].

The indicator will light, and the RHYTHM button [BD]- [OTHERS] indicators will show the current status for each rhythm group.



Blinking: The playback data is muted.

Lit: The playback data is not muted.

Dark: There is no playback data.

2. Press the RHYTHM button for the rhythm group that you wish to mute.

The indicator of the button you pressed will begin blinking, and the playback data will be muted.

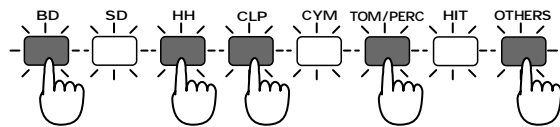

To cancel muting, press the muted RHYTHM button to make the indicator light.

* The indicator will not light even if you press the RHYTHM button of a rhythm group that is dark.

You can modify the mute status of each rhythm group, and save the settings in a user pattern.

☞ “Saving Patterns You’ve Modified (Pattern Write)” (p. 26)

* Rhythm mute settings will not be active if the Part Mute function has been used to mute the rhythm part itself.

* The rhythm tones that are muted by each RHYTHM button will depend on the selected rhythm set.

If you would like to know which rhythm tones correspond to each rhythm group...

☞ “Preset Rhythm Set List” (p. 196)

Other type of muting

In addition to Part Mute and Rhythm Mute, a variety of other muting operations are available. Use them as appropriate for your needs.

Simultaneously muting all parts (All Mute)

Hold down [Part Mute] and press [Rhythm Mute] (or hold down [Rhythm Mute] and press [Part Mute]). The indicator of [PART MUTE] will blink and all parts will be muted. Perform the same operation once again to return to the previous condition.

Playing back only a specific part (Monitor)

Hold down [PART MUTE] and press the PART button for the part that you wish to hear.

Exchanging the mute status of each part (Mute Exchange)

Hold down [PART MUTE] and press [PART SELECT].

Playing back the next pattern with the current mute settings (Mute Remain)

With the next pattern selected, press [PLAY] to make the indicator blink, and the current mute status will be maintained for the next pattern.

Transposing During Playback (Real-Time Transpose)

2 During pattern playback you can freely transpose to any key.

Using the VALUE Dial or [INC] [DEC]

1. Hold down [TRANSCOPE] and use the [VALUE] dial or [INC] [DEC] to specify the transpose value.

Range: -12+12 semitones (factory setting is 0)

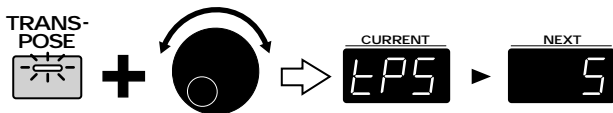

The display will indicate the current setting while you continue pressing the button.

2. The transposition will be applied from the moment that you release the button.

To return to the original key, press [TRANSCOPE] once again to make the button indicator go dark.

Using the Keyboard Pads

1. Hold down [TRANSCOPE] and press a keyboard pad to set the transpose value.

The transpose value can be set in a range of -12+12 semitones, above and below the C4 key (which will be keyboard pad [2] if Octave Shift is "0").

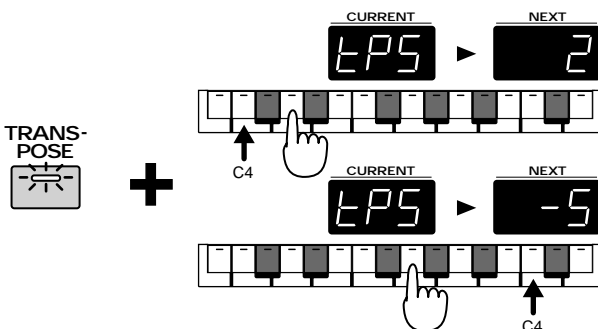

To specify a negative value, set Octave Shift to "-1."

2. The transposition will be applied from the moment that you press the keyboard pad.

To return to the original key, press [TRANSCOPE] once again to make the button indicator go dark.

"Shifting the Keyboard Range in One-Octave Steps (Octave Shift)" (p. 23)

* When the power is turned on, Real-Time Transpose will always be set to "0."

* When the [PTN CALL] or [RPS] indicator is lit, the keyboard pads cannot be used to make settings.

Using the Keyboard Pads to Play Sounds

1. Make sure that the [PTN CALL] and [RPS] indicators are both dark.

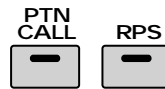

2. Press [PART SELECT].

The indicator will light.



3. Press the PART button for the part that you wish to play.

The indicator will light.

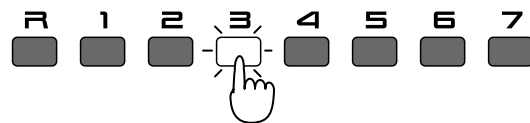

4. Play the keyboard pads, and you will hear the sound of that part.

If a MIDI keyboard is connected, you can play the keyboard to hear the sound of the part selected by the PART button. The keyboard pads correspond to an actual keyboard as follows:

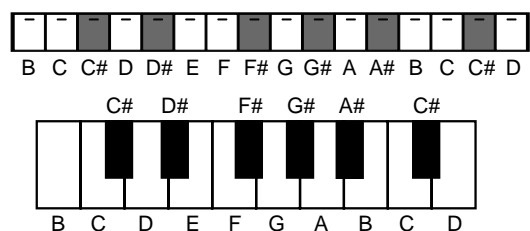

The part selected by the PART SELECT button and PART buttons is referred to as the “current part.”

Checking the parts that are sounding

When the [PART SELECT] indicator is lit, the part indicators [R]–[7] will light at the timing at which keyboard pads are played or notes of the pattern are played. This is convenient when you wish to know which parts are currently sounding.

Shifting the Keyboard Range in One-Octave Steps (Octave Shift)

Octave Shift is a function that shifts the pitch of the keyboard pads in one-octave units. This lets you shift the range of the keyboard pads to the most convenient range for playing.

Normally when you press keyboard 2, the pitch of the C4 note (middle C) will sound. (Both OCTAVE buttons dark.)

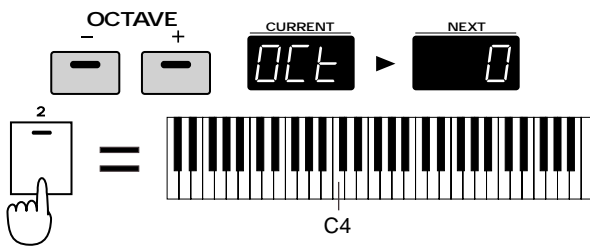

1. Press OCTAVE [-] [+] to shift the pitch range (-4#4).

The keyboard will be shifted in the +/- direction, and the button indicator will light.

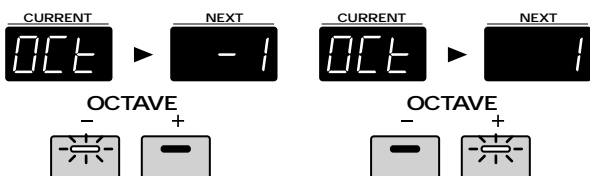

Each time you press OCTAVE [+], the range will be shifted upward by one octave. Each time you press OCTAVE [-], the range will be shifted downward by one octave. While you are pressing an OCTAVE button, the display will indicate the current setting. You can press the OCTAVE[-] [+] buttons simultaneously to return immediately to the normal key range.

Selecting Sounds (Patch)

1. Use [PART SELECT] and the PART buttons to select the current part.

For parts 1 through 7, you can select patches. For the rhythm part, you can select rhythm sets.

2. Press [PATCH].

The indicator will light.

The display will indicate the bank, number and name of the currently selected patch (rhythm set).

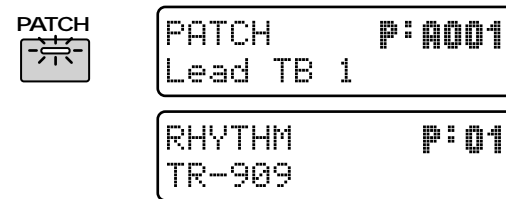

3. Press either [PRESET], [USER], or [CARD] to select the bank.

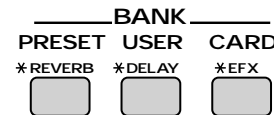

Patch banks are organized as follows:

[PRESET] P:A–D (preset banks)

[USER] U:A, B (user banks)

[CARD] C:A–D (card banks)

Each time you press the same bank button, the bank will cycle in the order of A->B->C->D...

Rhythm set banks as organized as follows:

[PRESET] P: (preset bank)

[USER] U: (user bank)

[CARD] C: (card bank)

* Card banks can be selected only if an optional memory card is inserted.

📖 “Using Memory Cards” (p. 159)

4. Use [INC] [DEC] or the [VALUE] dial to select the number.

Available settings:

Patch: P:A001–P:D128, U:A001–U:B128, C:A001–C:D128

Rhythm set: P:01–P:26, U:01–U:20, C:01–C:20

The number and name in the display will change.

The patch (rhythm set) has now been selected.

📖 If you would like to know what patches/rhythm sets are available...

👉 “Preset Patch List” (p. 192)

👉 “Preset Rhythm Set List” (p. 196)

Hold

If you press [HOLD] to make the indicator light, the sound will continue even after you take your finger off of the keyboard pad. Press [HOLD] once again to make the indicator go dark, and the sound will stop.

Using the Part Mixer to Modify Pattern Settings

2 You can use the eight Part Sliders to adjust various pattern settings, such as the volume and pan for each part. These settings can even be modified in real time while a pattern is playing, and slider movements can be recorded in a pattern.

"Recording Part Mixer Movements" (p. 130)

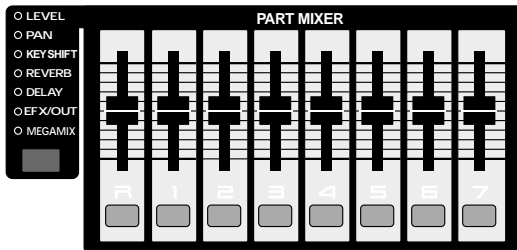

Adjusting the Volume of Each Part (Part Level)

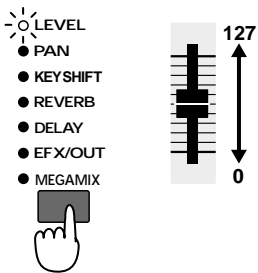

1. Press [MIXER SELECT] several times to make the LEVEL indicator light.
2. Move part sliders [R]⏏ [7] to adjust the volume of each part.

Range: 0–127

Raising a slider will increase the volume. Lowering it will decrease the volume.

With a setting of "127," the volume setting of the patch itself will be fully active.

Adjusting the Pan of Each Part (Part Pan)

You can adjust the stereo location in the stereo output from the various OUTPUT jacks (MIX L/R, DIRECT1 L/R, DIRECT2 L/R). For example, you might place the drums and bass in the center, the piano at right, and a pad at left.

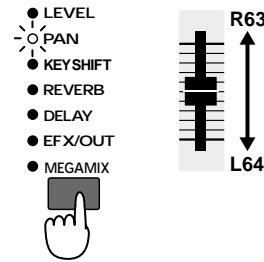

1. Press [MIXER SELECT] several times to make the PAN indicator light.
2. Move the part sliders [R]⏏ [7] to adjust the pan of each part.

Range: L64–63R

Raising a slider will move the sound toward the right. Lowering it will move the sound toward the left.

When this setting is at "0," the setting of the patch itself will be unaffected.

* Pan is specified independently for each tone of a patch (or each rhythm tone of a rhythm set). Modifying the Part Pan applies a relative change to the overall panning of the patch or rhythm set.

* For some patches, a small amount of sound may be heard from the opposite speaker even if the pan is set to full left or full right. Also, the Part Pan setting will have no effect in the following cases.

- When monaural connections are used
- Tones/rhythm tones for which Random Pan is ON

"Causing Pan to Change Randomly (Random Pan Switch)" (p. 46, 72)

- Patches/rhythm tones to which a mono-output EFX (spectrum, overdrive, distortion, noise generator, phonograph, limiter, phaser) is applied

The same applies for the Lo-Fi or Radio Tuning effects if the output setting of them is set to MONO.

"Applying Various Effects to the Sound (EFX)" (p. 86)

"Applying EFX/Specifying the Output Destination for Each Part (Part EFX/Output Assign)" (p. 104)

Adjusting the Pitch of Each Part (Part Key Shift)

You can adjust the pitch of the sound of each part.

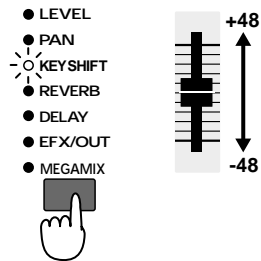

1. Press [MIXER SELECT] several times to make the KEY SHIFT indicator light.

2. Move the part sliders [R]D [7] to adjust the pitch of each part.

Range: -48+48 semitones

Raising the slider will raise the pitch. Lowering the slider will lower the pitch.

If you hold down [SHIFT] and move the slider, the pitch will change in units of an octave (12 semitones).

When the value is "0," the original pitch of the patch itself will be used without change.

In some cases, the location of each slider before it is moved may not match the actual setting. When you press [TEMPO/MIXER], the display will graphically indicate the current setting of each part. This is convenient when you wish to check the current settings. The current setting of the current part is shown at the right, which is convenient when you wish to make detailed settings. At this time you can use [INC] [DEC] to modify the setting values of the current part.

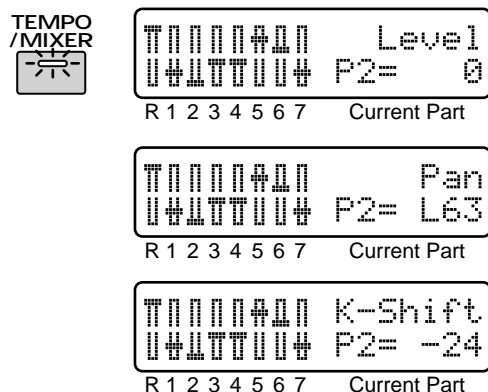

Selecting parameters in the opposite direction
Hold down [SHIFT] and press [MIXER SELECT], and the indicator will advance in the direction opposite to normal.

In addition to this, you can use the sliders to adjust things such as the effect depth for each part.

☞ "Adjusting the Reverb Volume for Each Part (Part Reverb Level)" (p. 80)

☞ "Adjusting the Delay Volume for Each Part (Part Delay Level)" (p. 84)

☞ "Applying EFX/Specifying the Output Destination for Each Part (Part EFX/Output Assign)" (p. 104)

Specifying the Output Destination for Musical Data (Sequencer Output Assign)

You can specify the output destination for the musical data of each part. For example, if you wish to use the MC-505 together with a sampler such as the SP-202, you can set Sequencer Output Assign to "EXT" for one or more of the parts. This will allow playback data from the MC-505 sequencer to control the external MIDI device.

If you want to control an external MIDI device such as a sampler...

☞ "Playing an External MIDI Device from the MC-505" (p. 174)

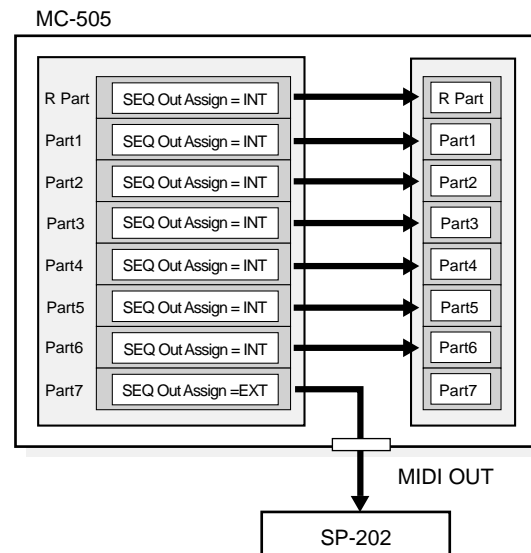

1. Hold down [SHIFT] and press keyboard pad [8].

The Sequencer Output Assign setting display will appear, and the screen will show the settings of each part.

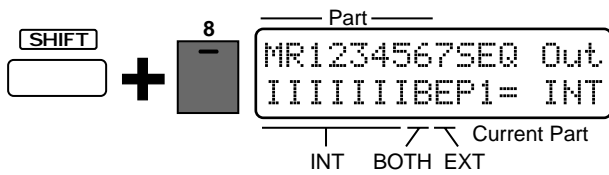

2. Use [PART SELECT] and the PART buttons to select the part for which you wish to modify settings.

The setting value for the selected part will be shown at the right of the display.

* "M" stands for the MUTE CTRL part, and mainly contains muting data and tempo data (p. 131, 141).

3. Use [INC] [DEC] or the [VALUE] dial to select the output destination.

INT (I): Musical data from the sequencer will be sent to the internal sound generator of the MC-505.

EXT (E): Musical data from the sequencer will be sent to an external device via MIDI OUT.

BOTH (B): Musical data from the sequencer will be sent both to the internal sound generator and from MIDI OUT.

* If "EXT" is selected, that part will not be heard even if you play back the pattern.

4. Press [EXIT] to leave the setting display.

Musical data from parts that are set to EXT will be transmitted as MIDI messages from MIDI OUT on a different MIDI channel for each part.

The musical data of each part is transmitted on the following MIDI channels.

- Rhythm part:** Ch. 10
- Part 1:** Ch. 1
- Part 2:** Ch. 2
- Part 3:** Ch. 3
- Part 4:** Ch. 4
- Part 5:** Ch. 5
- Part 6:** Ch. 6
- Part 7:** Ch. 7

.....
 If you wish to use the keyboard pads to directly play an external MIDI device, set the Local Tx Switch of that part to "EXT."

"Disconnecting the Keyboard Pads from the Internal Sound Generator (Local Tx Switch)" (p. 169)

Saving Patterns You've Modified (Pattern Write)

If you have modified the patch and part mixer settings for each part to create a pattern that you wish to keep, you can save that pattern as a User Pattern.

1. Make sure that the pattern is stopped.
2. Press [PTN/SONG] to access the pattern select page.

3. Press [WRITE].

The following display will appear, and "_" (the cursor) will appear below the number.



If you do not wish to change the number or name, you can skip steps 4–8.

If you decide not to save the pattern, press [EXIT].

4. Press [USER] or [CARD] to select the save destination bank.

* CARD banks can be selected only if an optional memory card is inserted.

"Using Memory Cards" (p. 159)

5. Use [INC] [DEC] or the [VALUE] dial to select the save destination number.

.....
 At this time, you can press [UNDO/REDO] to check the name of the pattern that is currently in the save destination number. After you have found a pattern that you do not mind overwriting, press [UNDO/REDO] once again to return to the previous display.

6. Press PAGE [>].

The cursor will move to the beginning of the second line of the display.

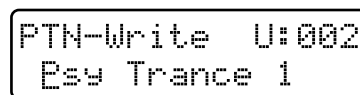

7. Assign a name to the pattern.

Use [INC] [DEC] or the [VALUE] dial to select characters.

The following characters are available.

space, A-Z, a-z, 0-9, ! " # \$ % & ' () * + , - . / : ; < = > ?
 @ [¥] ^ _ ` { | }

8. Repeat steps 6D7 to input the name.

You can move the cursor back toward the left by pressing PAGE [<].

9. Press [ENTER].

The confirmation screen will appear in the display. If you decide to cancel the operation, press [EXIT].



10. Press [ENTER] once again.

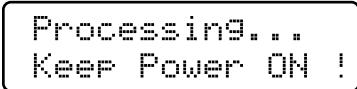

The Pattern Write operation will be carried out, then the normal display will reappear. The pattern has now been saved.

On the MC-505, the following parameters are saved for each pattern.
 Standard Tempo (p. 20)
 Patch Number * (p. 23)
 Part Level * (p. 24)
 Part Pan * (p. 24)
 Part Key Shift * (p. 25)
 Part Reverb Level * (p. 80)
 Part Delay Level * (p. 84)
 Part EFX/Output Assign * (p. 104)
 Reverb settings (p. 79)
 Delay settings (p. 82)
 EFX settings (p. 86)
 Part Mute status * (p. 21)
 Rhythm Mute status (p. 21)
 Sequencer Output Assign * (p. 25)
 The "*" indicates parameters that are set independently for each part.
 These parameters are collectively referred to as the "setup parameters."

Copying and Initializing Settings

Setup Copy

This operation copies the setup parameters of a specified pattern to the temporary pattern.

1. Press [PTN/SONG] to access the pattern select page.
2. Hold down [SHIFT] and press [PARAM COPY].

The display will indicate the copy source pattern, copy source part, and copy destination part.

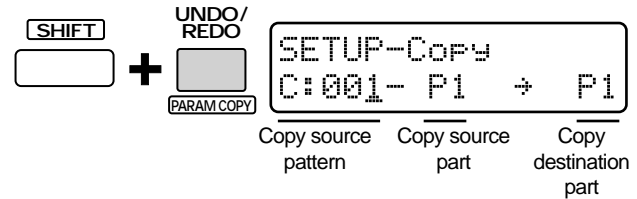

3. Use [INC] [DEC] or the [VALUE] dial to specify the copy source pattern, the copy source part, and the copy destination part.

You can move the cursor by pressing PAGE [<] [>].

Available settings for the part:

- R, P1-P7: Setup parameters of the specified part
- FX: Effect setup parameters
- ALL: All setup parameters

If the copy source part setting is "FX" or "ALL," it will not be possible to specify the copy destination part.

4. Press [ENTER].

The confirmation screen will appear in the display.

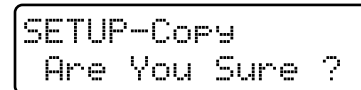

5. Press [ENTER] once again.

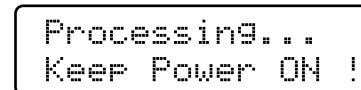

The Setup Copy operation will be carried out, then the normal display will reappear. If you decide to cancel the operation, press [EXIT]. To save the copied pattern, use the Pattern Write operation.

"Saving Patterns You've Modified (Pattern Write)" (p. 26)

Pattern Initialize

This operation initializes a pattern to a state of containing no musical data (empty pattern).

1. Press [PTN/SONG] to access the pattern select page.
2. Select the pattern that you wish to initialize.

* It is not possible to initialize if you select a preset pattern.

3. Hold down [SHIFT] and press [INITIALIZE].

The confirmation screen will appear in the display.



4. Press [ENTER].

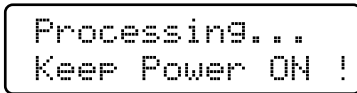

The Pattern Initialize operation will be carried out, then the normal display will reappear.

The pattern that was initialized will be saved automatically.

2

Using the Knobs to Modify the Sound During Playback (Real-Time Modify)

You can freely modify the sound of a patch by moving the sound parameter knobs while a pattern is playing. This capability is referred to as Real-Time Modify, and is especially effective when used during a live performance. There are several ways in which Real-Time Modify can be performed, and you can modify the sound either of the entire patch or of individual rhythm tones, etc.

Modifying the Sound of an Entire Patch

Here's how to modify the entire patch (rhythm set) that is selected as the current part.

1. Select a pattern, and play it (p. 19).

Make the [PTN CALL] and [RPS] indicators go dark.

2. Use [PART SELECT] and the PART buttons to select the current part.

3. Make sure that the [TONE SELECT] indicator is dark.

If it is lit, press [RHYTHM MUTE] to make the [TONE SELECT] indicator go dark.

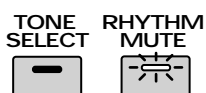

In this state, you can modify all tones (rhythm tones) of the entire patch.

4. Use the knobs to modify the sound.

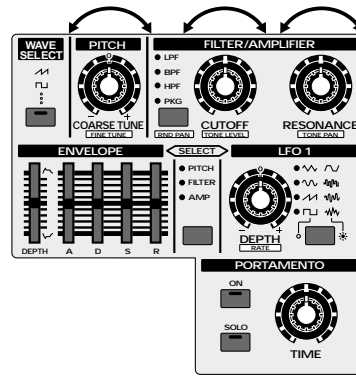

Real-Time Modify can be used with the knobs and buttons of the PITCH section, FILTER/AMPLIFIER section, ENVELOPE section, LFO1 section and PORTAMENTO section.

When modifying the rhythm part, parameters of the LFO1 section and the PORTAMENTO section are not used.

If you wish to learn about the function of each knob and button...

“Creating Original Sounds (Patch Edit/Rhythm Edit)” (p. 33)

You can switch the current part during playback to change the part that you are modifying.

Modifying the Sound of an Individual Tone

Patches can consist of up to four tones, and you can use Real-Time Modify to modify each tone individually.

1. Select a pattern, and play it (p. 19).

Make the [PTN CALL] and [RPS] indicators go dark.

2. Select a part 1D7 as the current part.

3. Press [TONE SELECT].

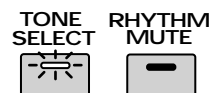

The indicator will light, and the RHYTHM buttons will be as follows.

Turning each tone on/off

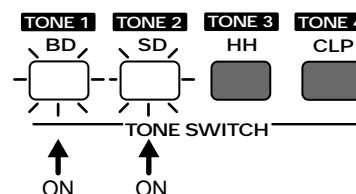

Tones that have their button indicator lighted are ON.

Selecting the tone for Real-Time Modify

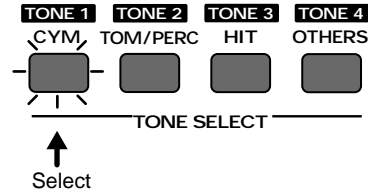

Tones with a blinking (lit) button indicator will be affected by Real-Time Modify. For example, in the case of the above diagram, tones 1 and 2 (out of tones 1–4) are ON (sounding), and tone 1 will be affected by Real-Time Modify.

4. Press one of the buttons [CYM]/[TOM/PERC]/[HIT]/[OTHERS] to select the tone that will be affected by Real-Time Modify.

The indicator of the selected button will begin blinking. When you press [TONE SELECT], all tones will always be selected.

By holding down one button while you press another button, you can also select two or more tones. When two or more tones are selected, the indicator of the first-pressed tone will be blinking, and the indicators of the tones that were pressed later will be lit. The panel indicators will show the Filter Type and LFO Waveform etc. of the blinking tone.

5. Use the knobs to modify the sound.

The part button indicator for the current part will begin blinking.

** If a tone that is turned off is selected for modification by Real-Time Modify, attempting to modify it will have no result. If you wish to play a tone that is turned off, press the appropriate button [BD]– [CLP] to make the button indicator light for the desired tone.*

Modifying the Sound for an Individual Rhythm Group

In the rhythm part, a different rhythm tone is assigned to each key, and you can use Real-Time Modify either to modify the sound of rhythm tone groups such as Bass Drum or Snare Drum, or to modify individual rhythm tones.

1. Select a pattern, and play it (p. 19).

Make the [PTN CALL] and [RPS] indicators go dark.

2. Select the rhythm part as the current part.

3. Press [TONE SELECT].

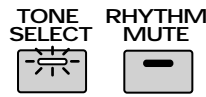

The indicator will light, and the RHYTHM buttons will indicate the rhythm group that is selected for Real-Time Modify.

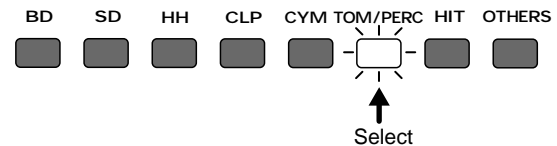

Rhythm groups with button indicators that are lit will be affected by Real-Time Modify.

For example, if you select [TOM/PERC], all toms and percussion-type rhythm tones in the rhythm set can be modified.

4. Press a button [BD] or [OTHERS] to select the rhythm group that will be affected by Real-Time Modify.

The indicator of the selected button will light.

It is not possible to select two or more groups simultaneously.

5. Use the knobs to modify the sound.

In addition to this, you can also modify each rhythm tone in the Rhythm Edit page.

[“Creating an Original Rhythm Set” \(p. 63\)](#)

By selecting a different current part or rhythm group, you can change the object of your modifications even while the pattern is playing.

Normally, the modified parameter settings will remain as they are even if you return to the beginning of the pattern.

These knob movements are referred to as “modify data,” and can be recorded in a pattern.

[“Recording Knob Movements \(Modify Data\)” \(p. 130\)](#)

Returning a Pattern to Its Original State During Playback

When you use Real-Time Modify, the pattern will remain in its modified state until a different pattern is selected. Here’s how you can restore a modified pattern to its original state during playback.

Restoring only the patch of a specific part that was modified

1. Press [PATCH] to access the patch select page.
2. Select the part that you wish to restore as the current part.
3. Press [UNDO/REDO], and the "*" (asterisk) at the left of the patch number will disappear, and you will return to the previous patch.

2

Restoring the patch (rhythm set) and part mixer settings of all parts that were modified

1. In the pattern select page, re-select the pattern that is currently playing (p. 19).

The pattern will return to the beginning, and the original settings will be restored.

The relation between modify data that was recorded and modify data from the knobs

If you perform Real-Time Modify while playing back a part for which modify data has already been recorded, the manual knob movements will take priority, and the modify data within the musical data for that part will be canceled, and will not be sent to the sound generator. (Note messages in the musical data will be sent to the sound generator regardless of knob operations.)

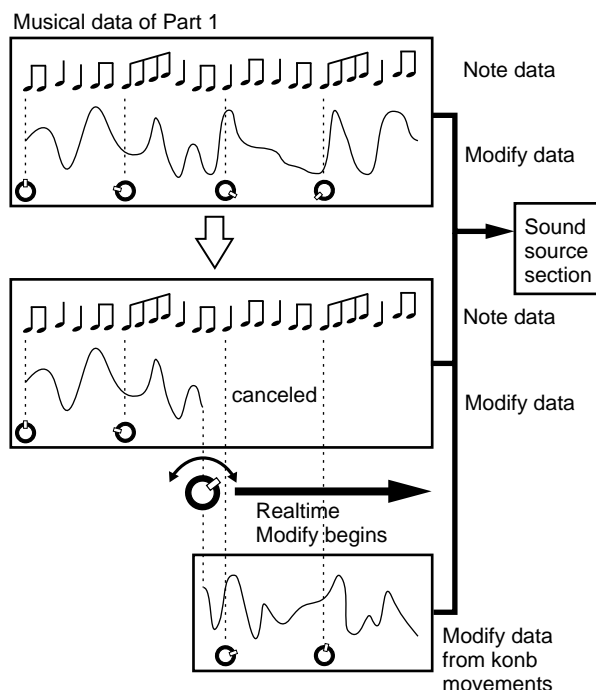

Modify Data that was canceled will once again be transmitted to the sound generator when the pattern returns to its beginning, or when you select a different pattern.

* Each knob has eleven switching points as calibrated on the panel. Modify Data within the musical data will be canceled from the moment that a knob is moved through one of these points.

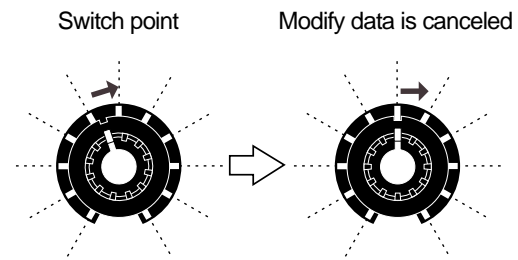

Ensuring Correct Playback from the Middle of a Pattern (MIDI Update)

When a pattern is played back from the middle after fast-forward or rewind, some parts (depending on the pattern) may have incorrect pitch or volume. This is because when you move to a different location within a pattern, the musical data that was "skipped over" is not transmitted to the sound generator. In such cases, use the MIDI Update function so that the musical data (other than note messages) that lies between the beginning of the pattern and the current location will be transmitted to the sound generator, ensuring that playback will occur correctly.

1. Make sure that the pattern is stopped.

2. Hold down [SHIFT] and press [STOP].

While this operation is being performed, the following display will appear.



Selecting Patterns from the Keyboard Pads (Pattern Set)

By using a pattern set, you can select patterns from the keyboard pads. A pattern set is a collection of two or more patterns, and up to 16 patterns can be assigned in each pattern set. The assigned patterns can be called up simply by pressing a keyboard pad.

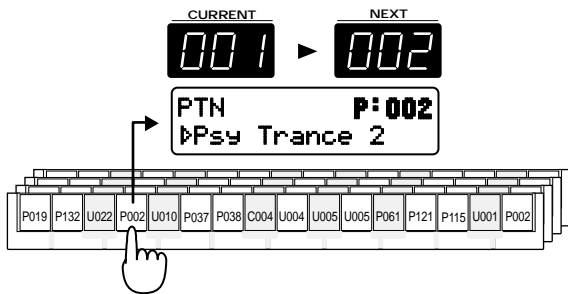

Select pattern P:002

Using a Pattern Set to Select a Pattern

1. Press [PTN CALL].

The indicator will light, and now you will be able to use the keyboard pads to select patterns.

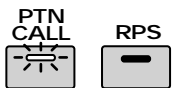

2. Press [PTN SET].

The indicator will light.

The display will indicate the bank, number and name of the currently selected pattern set.

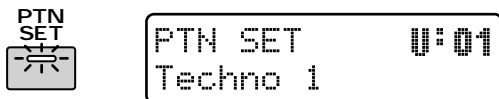

3. Press [USER] to select the user bank.

* For pattern sets, it is not possible to select the preset bank or card bank.

4. Use [INC] [DEC] or the [VALUE] dial to select the number.

Range: U:01–U:30

The selection in the display will change.

The pattern set has now been selected.

5. Press a keyboard pad, and the assigned pattern will be called.

Even while a pattern is playing, you can call patterns or change the pattern set.

When the [PTN SET] indicator is lit, you can also use OCTAVE [-] [+] to select a pattern set.

Registering the Patterns to Be Called

You are free to re-assign the patterns in each pattern set. You may find it convenient to collect favorite patterns into a pattern set, or to put frequently-used patterns into a pattern set. As an example, here's how to assign pattern P:010 in a pattern set.

First select the pattern set into which you will newly assign a pattern.

1. Select pattern P:010 (p. 19).

2. Make sure that [PTN CALL] indicator is lit.

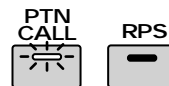

3. Hold down [PTN CALL], and press the keyboard pad to which you would like to assign that pattern.

The selected pattern will be assigned to the keyboard pad that you pressed. For example, if you wish to assign the pattern to keyboard pad [7], use the following procedure.

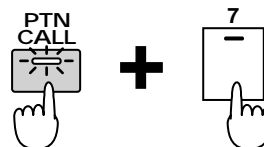

A pattern can be assigned even during pattern playback.

* When playing back a pattern that is only one measure long, it will sometimes be impossible to select patterns from the keyboard pads.

Registering a variation of a pattern

If you assign a pattern with modified setup data (patch number and mute status etc. of each part), the pattern will be called from the pattern set in the same state as when it was assigned. By taking advantage of this, you can create a variety of variations based on a single user pattern, without having to save additional new patterns.

* Patterns that were assigned with modified settings cannot be selected by the normal pattern select procedure.

Saving a Pattern Set That Was Modified (Pattern Set Write)

When you have assigned patterns to create a pattern set that you like, you should save the result as a user pattern set.

1. Make sure that the pattern is stopped.
2. Press [PTN SET] to access the pattern set select page.

When you modify the contents of a pattern set, an asterisk "*" will appear at the left of the number, indicating that the selected pattern set has been modified (edited). Be aware that if you turn off the power without saving the modified pattern set, the previous settings will reappear.

3. Press [WRITE].
The following display will appear, and "_" (cursor) will appear under the number.



If you do not wish to change the number or name, you can skip steps 4-8. If you decide not to save the pattern, press [EXIT].

4. Select the save destination bank.
When saving a pattern set, only user bank can be selected.
5. Use [INC] [DEC] or the [VALUE] dial to select the save destination number.

.....
At this time, you can press [UNDO/REDO] to check the name of the pattern set that is currently in the save destination number. After you have found a pattern set that you do not mind overwriting, press [UNDO/REDO] once again to return to the previous display.
.....

6. Press PAGE [>].
The cursor will move to the beginning of the second line of the display.

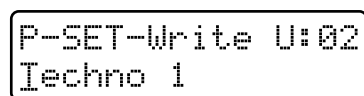

7. Assign a name to the pattern set.
Use [INC] [DEC] or the [VALUE] dial to specify the character.
The following characters are available.

Space, A-Z, a-z, 0-9, ! " # \$ % & ' () * +, - . / : ; < = > ?
@ [¥] ^ _ ` { | }

8. Repeat steps 6D7 to enter the name.
By pressing PAGE [<] you can move the cursor back toward the left.

9. Press [ENTER].
The confirmation screen will appear in the display. If you decide to cancel the operation, press [EXIT].

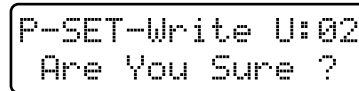

10. Press [ENTER] once again.

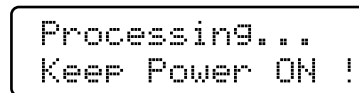

The pattern set write operation will be carried out, then the normal display will reappear. The pattern set has now been saved.

Although you can use Real-Time Modify to modify the sound of a patch in real time while a pattern plays, it is also possible to modify the various aspects of the sound beforehand to create the perfect patch for your music. This process is called Patch Edit (Rhythm Edit), and like Real-Time Modify, allows you to make detailed parameter settings for each tone or rhythm tone.

The sound parameters that can be set during patch editing and rhythm editing are referred to as Patch parameters and Rhythm Set parameters, respectively.

Creating an Original Patch

Sound-Editing Procedure

1. Select one of the parts 1D7 as the current part.
2. Select the patch that you wish to edit (p. 23).
3. Make sure that the patch select page is displayed.
4. Press [TONE SELECT].

The indicator will light, and the RHYTHM buttons will be as follows.

Turning each tone on/off

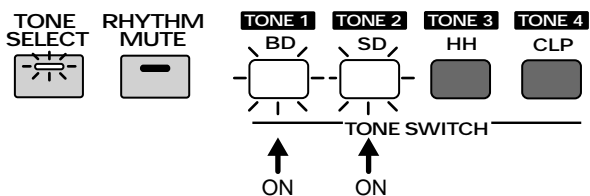

Tones that have their indicator lit are on. You can press each button to turn the corresponding tone on/off.

Selecting the tone for editing

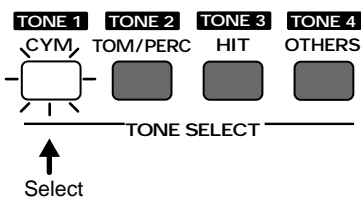

The tone with a blinking (lit) button indicator will be affected by your editing.

5. Press [EDIT].

The indicator will light, and an editing page will

appear.

The various editing pages show the currently selected patch parameter, and the setting values for each tone. The tone to which your editing will apply is indicated by “█” shown at the left of the value. In the following illustration, TONE 1 is being edited.

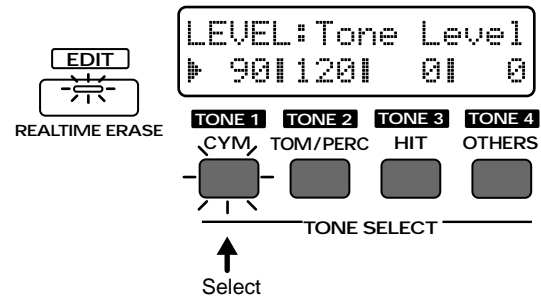

6. Press one of the [CYM]/[TOM/PERC]/[HIT]/[OTHERS] buttons to select the tone that you wish to edit.

The indicator of the selected button will begin blinking, and “█” will be displayed at the left of the setting value.

You can select two or more tones by holding down one of the buttons while you press another button.

* When two or more tones are selected, the indicator of the first-pressed tone will be blinking, and the indicators of the subsequently-pressed tones will be lit. The panel indicators will show the filter type and LFO waveform settings etc. for the blinking tone.

7. Select the patch parameter that you wish to modify, and edit it.

To exit the editing pages, press [EDIT].

There are two ways to select patch parameters.

Using knobs or buttons to select an editing page

By operating a front panel knob or button, you can directly access the screen page for that parameter, and edit it. For example, if you rotate the [CUTOFF] knob, the display will automatically change to the Cutoff Frequency setting page, and you can edit the setting while viewing the values for each tone.

Accessing only the editing page without modifying the setting value

If you wish to see the current setting before you make any changes, hold down [EDIT] while you operate the knob, and you will access only the editing page without modifying the value. This is convenient when you wish to view the current parameter values as you edit.

Maintaining the relative difference between tones when editing

In an editing page, you can use [INC] [DEC] or the [VALUE] dial to edit while preserving the relative difference between tones. Use this method when appropriate.

** This method cannot be used to edit parameters for which there is no knob or button on the front panel.*

Selecting pages for each section and editing

In this method you can press [EDIT]+keyboard pad to access the edit pages for each section, use PAGE [<] [>] to switch parameter screens within each section, and then edit the desired parameter. This allows you to edit all parameters, and is a good method when you wish to create sounds in a logical sequence such as "waveform" -> "pitch" -> "brightness," and so forth. Use [INC] [DEC] or the [VALUE] dial to modify the values. You can also operate part sliders [4]-[7] to modify the values of TONES 1-4 individually (Tone Pallet).

For the procedure of how to access each section page, refer to "Making More Detailed Settings" for each section.

An asterisk "*" will be displayed at the left of the bank of an edited patch. This indicates that the settings of this patch have been modified.

If you select a different patch when the "*" is displayed, the modified settings will be lost. If you wish to keep the edited patch, you must perform the Patch Write operation.

 "Saving Patches You've Created (Patch Write)" (p. 61)

Changing the Basic Waveform of the Sound (Wave/FXM)

In the WAVE/FXM section, you can make settings related to the waveform that is the basis for a synthesizer's sound.

Selecting the Basic Waveform (Wave Select)

For each tone, select the waveform that will be the basis of the sound.

1. Press [WAVE SELECT].

The indicator will light, and the Waveform Select setting page will appear.

Your editing will apply to the tone (s) that has its group name (A/B) displayed in capital letters.

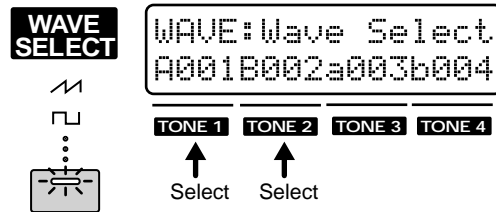

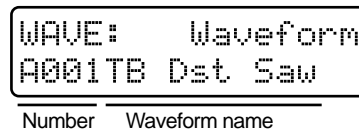

If only one tone is selected for editing, the waveform name will be displayed as follows:



2. Use [INC] [DEC] or the [VALUE] dial to select the waveform.

Range: A001-A254, B001-B251

 If you would like to learn what waveforms are available...
 "Waveform List" (p. 190)

It would not be an exaggeration to say that the major part of a sound is determined by the waveform that you select. Once you have an idea of the desired sound, select a waveform that you think will be suitable.

Sawtooth wave

This is used as the original waveform for most instruments other than woodwinds. Many characteristic synthesizer sounds can be created using this waveform.

-> A001, A006-A008, A013-A021

Square wave

This waveform is close to the sound of a woodwind instrument. Many characteristic synthesizer sounds can also be created using this waveform.

-> A002-A005, A009, A010, A022-A024

Triangle wave

This waveform has fewer overtones, and produces a less distinctive sound. It is used for making flute-type sounds.

-> A038

Sine wave

A soft sound without much character.

->A039, A040

For most instrumental sounds, you will want to select one of the following types of waveforms.

- Organ -> A072-A079
- Brass -> A102-A108
- Piano -> A068-A070
- Drums -> A202-A254, B001-B251

Making More Detailed Settings

1. Hold down [EDIT] and press keyboard pad [1].

The display will show the WAVE section setting page.

2. Use PAGE [<] [>] to select parameters within the section, and edit them.

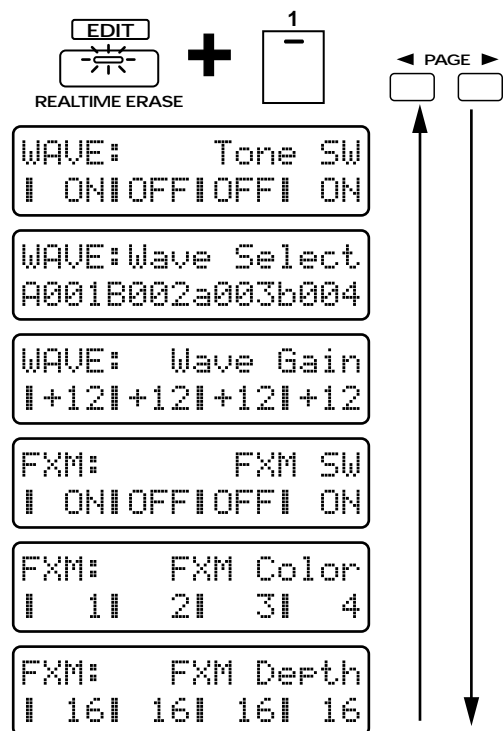

Tone SW (Tone Switch)

Turn this “ON” if you want the tone to sound, or “OFF” if you do not want the tone to sound.

In order to make the best use of the available polyphony, unused tones should be turned “OFF.”

* The setting of this parameter will be modified when you use the tone buttons ([BD]/[SD]/[HH]/[CLP]) to turn each tone on/off.

Wave Select

This is the setting page for “Selecting the Basic Waveform (Wave Select)” (p. 34).

Wave Gain

This boosts the waveform. Raising this setting 6 dB will double the gain. If you are using the booster to distort the sound, setting this to the maximum value will be effective.

Range: -6, 0, +6, +12

If you would like to learn more about booster gain settings...

“Changing How Tones Are Combined and Played (Common)” (p. 54)

FXM (Frequency Cross Modulation)

FXM (Frequency Cross Modulation) uses a specific waveform to apply frequency modulation to the selected waveform, creating complex overtones. This is useful for creating dramatic sounds or sound effects.

3

FXM SW (FXM switch)

When you wish to use FXM, turn this “ON.”

FXM Color

Select one of four types of frequency modulation for FXM to apply.

Range: 1-4

As this value is increased, the sound will become rougher. Lower values will produce a metallic sound.

FXM Depth

Adjusts the depth of frequency modulation produced by FXM.

Range: 1-16

As this value is increased, modulation will be applied more deeply. As the value is decreased, modulation depth will decrease.

Modifying the Pitch (Pitch)

In the PITCH section you can make settings that affect the pitch.

Approximate Adjustments to the Pitch (Coarse Tune)

Adjust the pitch of each tone in semitone steps.

1. Make sure that the [FUNC] indicator is dark.
2. Rotate the [COARSE TUNE] knob to set the Coarse Tune setting.

3



Range: -48—+48 semitones
Rotating the knob clockwise will raise the pitch. Rotating it counterclockwise will lower the pitch.

Fine Adjustments to the Pitch (Fine Tune)

You can adjust the pitch of each tone in 1-cent steps (1/100th of a semitone).

1. Press [FUNC] to make the indicator blink.
2. Rotate the [FINE TUNE] knob to adjust the Fine Tune value.

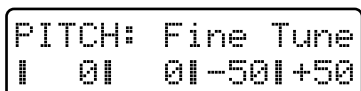

Range: -50—+50
Rotating the knob clockwise will raise the pitch. Rotating it counterclockwise will lower the pitch.

Making the sound more spacious

If you select the same waveform for two tones, set the same Coarse Tune value for both tones and then use Fine Tune to create a slight pitch difference between the two tones, the sound will appear more spacious (the Detune effect).

Making More Detailed Settings

1. Hold down [EDIT] and press keyboard pad [2].
The display will show the PITCH section setting page.
2. Use PAGE [<] [>] to select parameters within the section, and edit them.

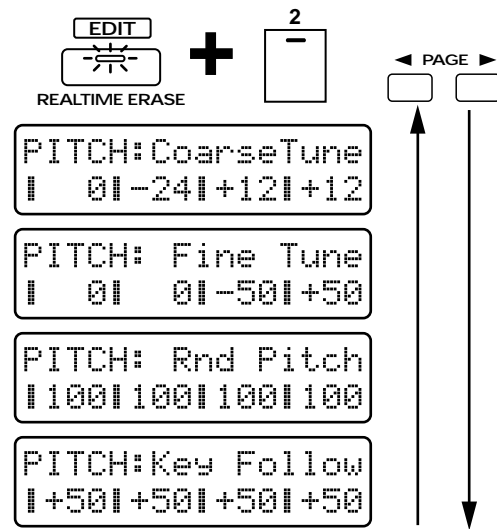

Coarse Tune

This is the setting page for “Approximate Adjustments to the Pitch (Coarse Tune).”

Fine Tune

This is the setting page for “Fine Adjustments to the Pitch (Fine Tune).”

Rnd Pitch (Random Pitch Depth)

This applies a degree of randomness to the pitch of each note.

Range: 0–1200

As this value is increased, a greater degree of randomness will be applied. As this value is decreased, there will be less randomness.

With a value of “0” there will be no effect.

Key Follow (Pitch Key Follow)

This setting causes the pitch to be affected by the key pad location.

Unless you are creating a special type of sound, you will normally leave this at "+100."

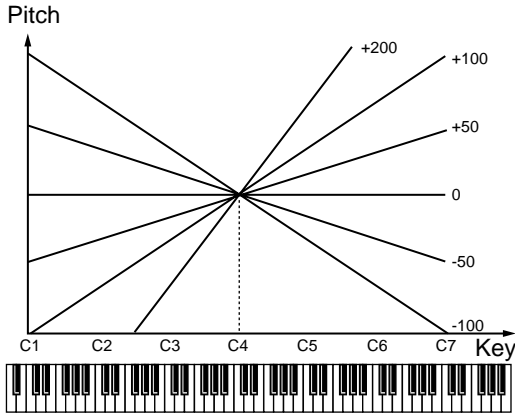

Range: -100—+200

With positive (+) settings, the pitch will rise as you play higher notes (i.e., notes toward the right of the keyboard). With negative (-) settings, the pitch will fall as you play higher notes.

-
- +100:** As on a conventional keyboard instrument, the pitch will rise one octave when you move 12 notes upward on the keyboard.
- +200:** The pitch will rise two octaves when you move 12 notes upward on the keyboard.
- 0:** The pitch will be the same regardless of which note you play.
- 100:** The pitch will fall one octave when you move 12 notes upward on the keyboard.

When you are creating sounds of instruments that naturally have minimal change in pitch, such as percussion instruments, it is effective to set Pitch Key Follow to a setting of "+10" or "+20."

.....

Making the Pitch Change Over Time (Pitch Envelope)

On acoustic instruments, the pitch sometimes changes over time, from when the sound begins until it decays to silence. For example, on brass instruments such as the trumpet, there is a slight instability in pitch when the beginning of the note is blown. The P-ENV (Pitch Envelope) section lets you make settings that specify this "change in pitch over time."

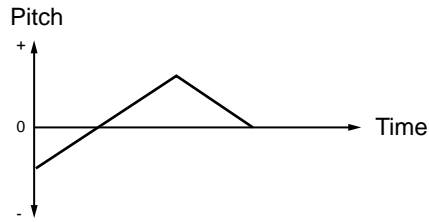

Pitch Envelope Settings

1. Press [ENV SELECT] several times to select PITCH.
2. Use the [A]/[D]/[S]/[R] sliders to set the pitch envelope values.

Available settings:
 [A]/[D]/[R]: 0–127
 [S]: -63–+63

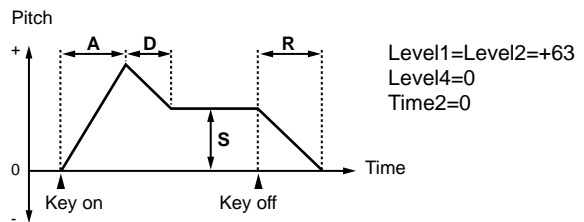
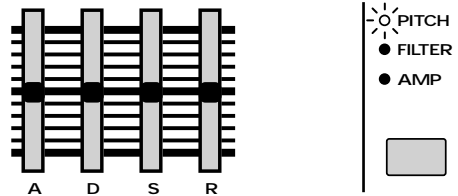

```
P-ENV: [A]Time1
| 20| 20| 0| 0|

P-ENV: [D]Time3
| 30| 30| 0| 0|

P-ENV: [S]Level3
| +63| +63| +63| +63|

P-ENV: [R]Time4
| 0| 0| 0| 0|
```

[A] (Attack Time)

The time from when the keyboard pad is pressed until the maximum pitch change is reached. Higher settings will cause the pitch to change over a longer time.

[D] (Decay Time)

The time from when the maximum pitch change is reached until the Sustain Level is reached.

Higher settings will cause the pitch to change over a longer time.

[S] (Sustain Level)

The pitch that will be held.

Positive (+) settings will make the pitch higher than the normal pitch. Negative (-) settings will make the pitch lower than the normal pitch.

[R] (Release Time)

The time from when the keyboard pad is released until the pitch returns to the normal pitch.

Higher settings will cause the pitch to change over a longer time.

3 Specifying the Envelope Depth (Pitch Envelope Depth)

Here's how you can adjust the depth of the Pitch Envelope.

1. Press [ENV SELECT] several times to select PITCH.
2. Use the [DEPTH] slider to adjust the Pitch Envelope Depth.

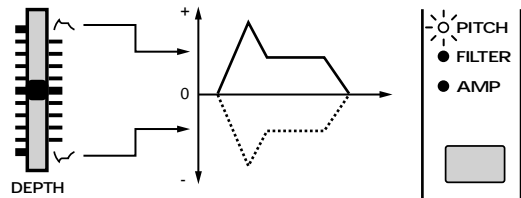

P-ENV: ENV Depth
I -12I -12I +12I +12

Range: -12+12

Increasingly positive (+) settings will produce a greater width of pitch change. Negative (-) settings will invert the shape of the envelope, causing the pitch to change in the opposite direction.

Making More Detailed Settings

1. Hold down [EDIT] and press keyboard pad [3].
The display will show the P-ENV section setting page.
2. Use PAGE [<] [>] to select parameters within the section, and edit them.

ENV Depth (Pitch Envelope Depth)

This is the setting page for “Specifying the Envelope Depth (Pitch Envelope Depth).”

Velo Sens (Pitch Envelope Velocity Sensitivity)

This setting lets you control the Pitch Envelope depth by the force with which you play the external MIDI keyboard.

Range: -100+150

With positive (+) settings, the pitch will change more greatly as you play the keyboard more strongly. With negative (-) settings, the pitch will change less as you play the keyboard more strongly.

** It is not possible to control this by varying the force with which you press the keyboard pads.*

When Velocity Sensitivity is set to a positive (+) value, softly-played notes will have little pitch change, and strongly-played notes will have greater pitch change; this lets you simulate “the pitch instability at the beginning of each note” that is characteristic of wind instruments.

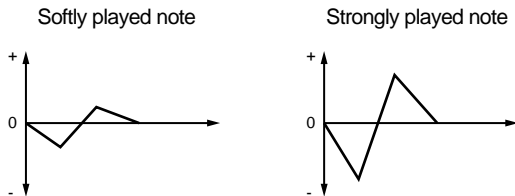

The four front panel sliders [A]/[D]/[S]/[R] can be used to set the most commonly-used parameters of the pitch envelope, but the MC-505 also allows you to make more detailed pitch envelope settings.

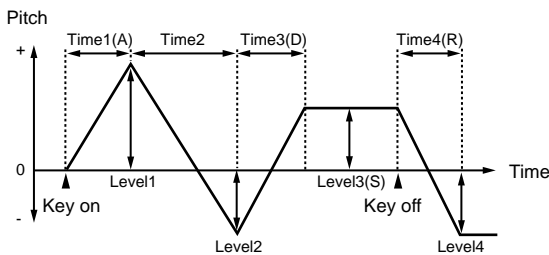

Time1D4 (Pitch Envelope Time 1D4)

Specifies the time until the next pitch level is reached. You can make settings for the four parameters Time 1–4.

Range: 0–127

Higher settings will result in a longer time until the next pitch level is reached.

* The front panel parameter [A] (Attack Time) corresponds to Time1, [D] (Decay Time) to Time3, and [R] (Release Time) to Time4.

Level1D4 (Pitch Envelope Level 1D4)

Specifies the pitch difference relative to the normal pitch (as specified by Coarse Tune and Fine Tune). You can make settings for the four parameters, Level 1–4.

Range: -63–+63

Positive (+) settings will raise the pitch above the normal pitch. Negative (-) settings will lower the pitch below the normal pitch.

* The front panel parameter [S] (Sustain Level) corresponds to Level3.

Velo Time1 (Pitch Envelope Velocity Time 1 Sensitivity)

This parameter lets your playing dynamics on the external MIDI keyboard control the Time1 time.

Range: -100–+100

With positive (+) settings, Time1 will become faster as you play the keyboard more strongly. With negative (-) settings, Time1 will become slower as you play the keyboard more strongly.

* It is not possible to control this by varying the force with which you press the keyboard pads.

When Velocity Time 1 Sensitivity is set to a positive value, the pitch will change slowly for softly-played notes, and rapidly for strongly-played notes. This is useful for creating sound effects, and the like.

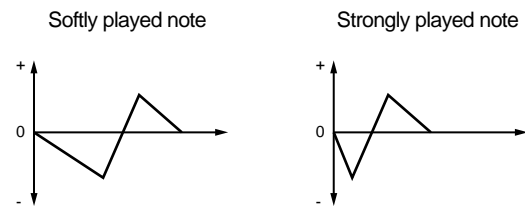

Velo Time4 (Pitch Envelope Velocity Time 4 Sensitivity)

This lets you control Time4 by the speed at which you release the external MIDI keyboard.

Range: -100–+100

With positive (+) settings, releasing the keyboard more quickly will cause Time4 to be faster. With negative (-) settings, releasing the keyboard more quickly will cause Time4 to be slower.

* It is not possible to control this by varying the speed with which you release the keyboard pads.

Time KF (Pitch Envelope Time Key Follow)

This setting causes the pitch envelope times (Time 2/3/4) to be affected by the keyboard pad position. Higher settings will produce a greater change relative to the C4 key envelope.

Range: -100–+100

With positive (+) settings, times will become shorter as you play higher notes. With negative (-) settings, times will become longer as you play higher notes.

Modifying the Brightness of the Sound (Filter)

Sound consists of a large number of overtones at various frequencies. By using a filter, you can cause only a specific range of overtones to be passed or attenuated, thus modifying the brightness. The FILTER section lets you make settings that affect the brightness of the sound in this way.

Selecting the Type of Filter (Filter Type)

Select the type of filter.

- 3**
1. Make sure that the [FUNC] indicator is dark.
 2. Press [FILTER TYPE] several times to select the type.

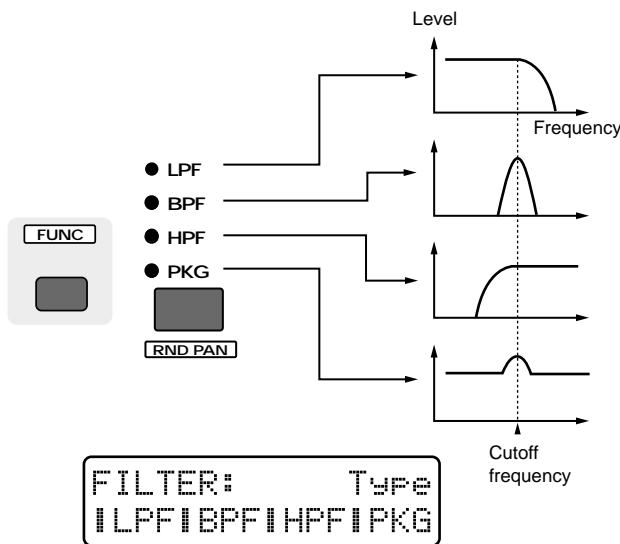

OFF:

The filter will not be used (all four indicators are dark).

LPF (Low Pass Filter):

This is the most common type of filter, and allows frequencies below the cutoff frequency to pass. It is used to make the sound more mellow.

BPF (Band Pass Filter):

This filter allows frequencies in the region of the cutoff frequency to pass, and cuts the rest.

HPF (High Pass Filter):

This filter allows frequencies above the cutoff frequency to pass. It is used to make the sound brighter and sharper.

PKG (Peaking Filter):

This filter boosts the overtones in the region of the cutoff frequency. It will emphasize the mid-range, and is useful for creating a distinctive sound.

By selecting the Peaking Filter as the Filter Type and using the LFO to modulate the cutoff frequency, you can create a “wah” effect.

“Adjusting the depth of cutoff frequency modulation (LFO1 Filter Depth)” (p. 52)

Brightening the Sound (Cutoff Frequency)

Specifies the frequency at which the filter will begin to affect the frequency components of the waveform (the Cutoff Frequency). By changing the cutoff frequency, you can control the brightness of the sound.

1. Make sure that the [FUNC] indicator is dark.
2. Rotate the [CUTOFF] knob to adjust the cutoff frequency value.

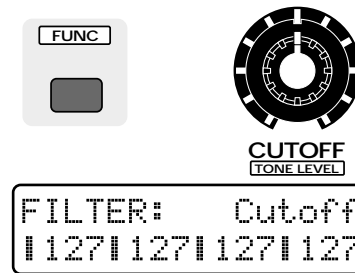

Range: 0–127

The effect will depend on the Filter Type.

LPF (Low Pass Filter)

Rotating the knob clockwise will cause the sound to become brighter, approaching the original waveform. Rotating it counterclockwise will cut more of the high frequency overtones, making the sound darker.

* For some waveforms, you may not be able to hear any sound if you lower the value too far.

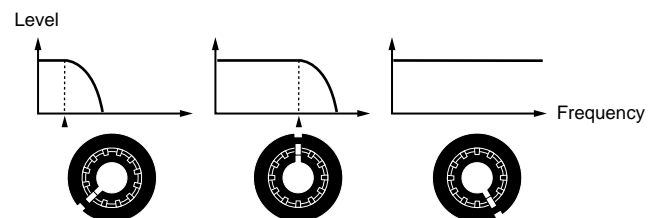

BPF (Band Pass Filter)

Rotating the knob clockwise will raise the frequency area that is heard. Rotating the knob counterclockwise will cause only a progressively lower frequency area to be heard.

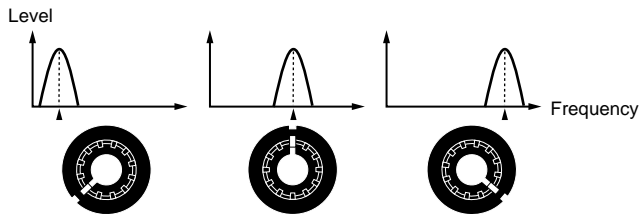

HPF (High Pass Filter)

When the knob is turned clockwise, the low frequency range will be cut more greatly, making the sound sharper. As the knob is rotated toward the left, the original sound of the waveform will be heard.

* For some waveforms, you may hear no sound if this value is raised excessively.

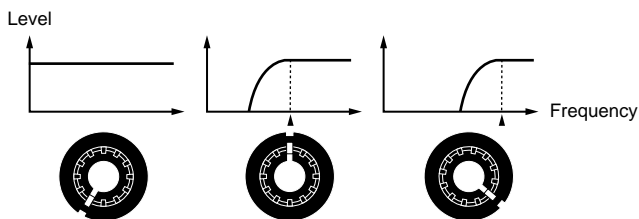

PKG (Peaking Filter)

When the knob is turned clockwise, the frequency area that is emphasized will rise. Rotating the knob counterclockwise will lower the frequency area that is emphasized.

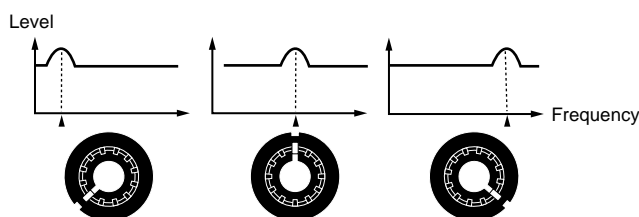

Adding a Distinctive Character to the Sound (Resonance)

This setting emphasizes the overtones in the region of the cutoff frequency, adding character to the sound.

1. Make sure that the [FUNC] indicator is dark.
2. Rotate the [RESONANCE] knob to adjust the resonance setting.



Range: 0–127

As the knob is rotated further clockwise, the sound will take on more character. Rotating it counterclockwise will make the sound more natural.

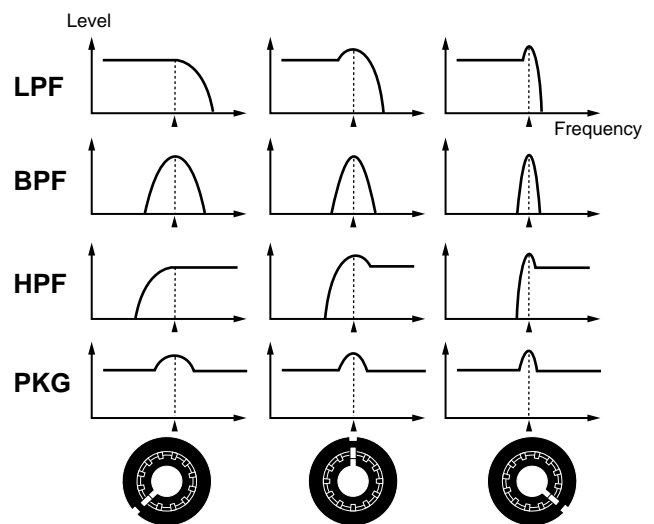

Depending on the cutoff frequency setting, raising the resonance excessively may cause the sound to distort suddenly. In particular when Low Boost is being applied, the sound will be more prone to distort, so rotate [LOW BOOST] counterclockwise to adjust the boost amount until the sound no longer distorts.

📖 🖱️ **“Using Low Boost to Adjust the Low Range”**
(Quick Start, p. 9)

In order to prevent the resonance from being increased excessively, factory settings have been made so that the value will not rise beyond “115” even if the [RESONANCE] knob is rotated all the way to the right. This is called the Resonance Limiter. You are free to adjust this upper limit.

📖 🖱️ **“Specifying the Variable Range of Resonance (Resonance Limiter)”** (p. 164)

If you have increased the Resonance Limiter setting, be careful not to raise the resonance excessively.

Making More Detailed Settings

1. Hold down [EDIT] and press keyboard pad [4].

The display will show the FILTER section setting page.

2. Use PAGE [<] [>] to select parameters within the section, and edit them.

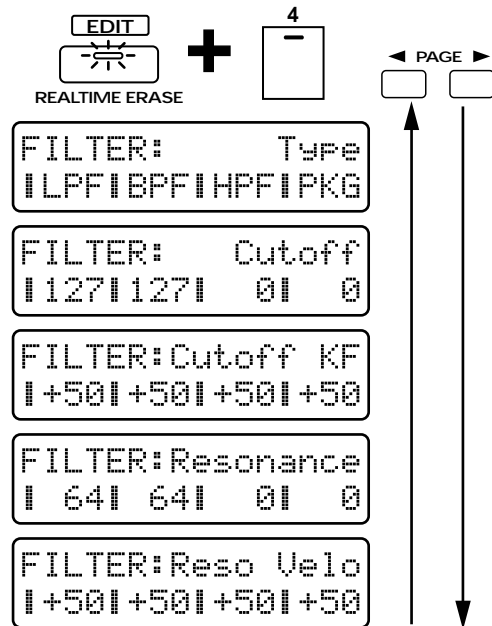

3

Type (Filter Type)

This is the setting page for “Selecting the Type of Filter (Filter Type)” (p. 40).

Cutoff (Cutoff Frequency)

This is the setting page for “Brightening the Sound (Cutoff Frequency)” (p. 40).

Resonance

This is the setting page for “Adding a Distinctive Character to the Sound (Resonance)” (p. 41).

Cutoff KF (Cutoff Frequency Key Follow)

This setting causes the cutoff frequency to be affected by the keyboard pad position.

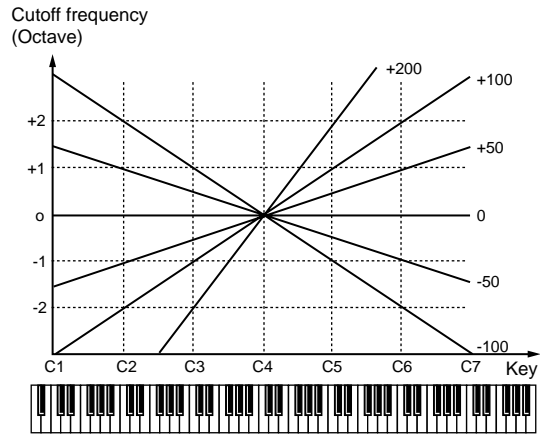

Range: -100—+200

With positive (+) settings, the cutoff frequency will also rise as you play higher notes. With negative (-) settings, the cutoff frequency will become lower as you play higher notes.

-
- +100:** When you move 12 notes upward from C4 on the keyboard, the cutoff frequency will rise one octave.
- +200:** When you move 12 notes upward from C4 on the keyboard, the cutoff frequency will rise two octaves.
- 0:** The cutoff frequency will be the same for all notes.
- 100:** When you move 12 notes upward from C4 on the keyboard, the cutoff frequency will fall one octave.

If you set Cutoff Frequency to a value of approximately “64,” the key follow effect will be easy to hear. On acoustic instruments, the tone also changes as the pitch moves upward or downward. For example, the sound of a piano becomes slightly more mellow as you play higher notes. To simulate this type of effect, set Key Follow to approximately 70.

Reso Velo (Resonance Velocity Sensitivity)

Specifies how resonance depth will be affected by your playing dynamics on the external MIDI keyboard.

Range: -100—+150

With positive (+) settings, playing the keyboard more strongly will cause the change to be greater. With negative (-) settings, playing the keyboard more strongly will cause the change to be less.

* It is not possible to control this by varying the force with which you press the keyboard pads.

Making the Brightness Change Over Time (Filter Envelope)

On acoustic instruments, the tone quality (brightness) often changes over the duration of a note. For example, on a piano, the sound at the beginning of each note contains many overtones (i.e., has a bright tone), and as the note decays to silence, the overtones diminish, making the sound more mellow. The F-ENV (Filter Envelope) section lets you create this type of tonal change over time.

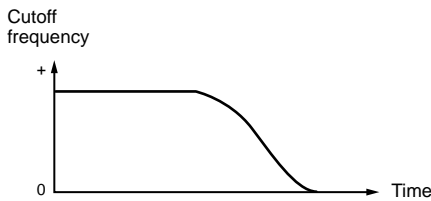

Filter Envelope Settings

1. Press [ENV SELECT] several times to select FILTER.
2. Use the [A]/[D]/[S]/[R] sliders to adjust the filter envelope values.

Range: 0-127

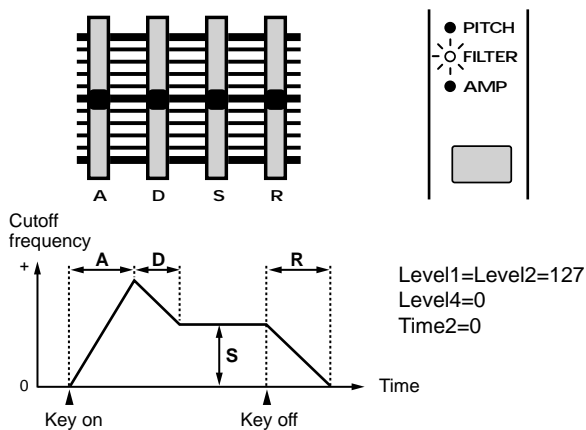

```
F-ENV: [A]Time1
| 10| 10| 10| 10
```

```
F-ENV: [D]Time3
| 30| 30| 30| 30
```

```
F-ENV: [S]Level3
|127|127|127|127
```

```
F-ENV: [R]Time4
| 0| 0| 0| 0
```

[A] (Attack Time)

The time from when the keyboard pad is pressed until the maximum tonal change is reached.

Higher settings will cause the tonal change to occur over a longer time.

[D] (Decay Time)

The time from when the maximum tonal change is reached until the Sustain Level is reached.

Higher settings will cause the tonal change to occur over a longer time.

[S] (Sustain Level)

The cutoff frequency level at which the tonal change will stabilize.

Raising this setting will also raise the cutoff frequency.

[R] (Release Time)

The time from when the keyboard pad is released until the sound disappears.

Higher settings will cause the tonal change to occur over a longer time.

3

Specifying the Depth of the Envelope (Filter Envelope Depth)

This setting adjusts the depth of the filter envelope.

1. Press [ENV SELECT] several times to select FILTER.
2. Use the [DEPTH] slider to adjust the Filter Envelope Depth setting.

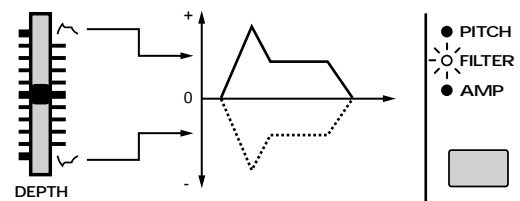

```
F-ENV: ENV Depth
| -63|+63| -63|+63
```

Range: -63+63

As the value is increased in the positive (+) direction, the amount of tonal change will increase. With negative (-) settings, the shape of the envelope will be inverted, and the tone will change in the opposite direction.

When setting Envelope Depth to a positive (+) value, the effect of the filter envelope will be easier to hear if you set a lower cutoff frequency. (With negative (-) Envelope Depth values, set a higher cutoff frequency.)

Making More Detailed Settings

1. Hold down [EDIT] and press keyboard pad [5].

The display will show the F-ENV section setting page.

2. Use PAGE [<] [>] to select parameters within the section, and edit them.

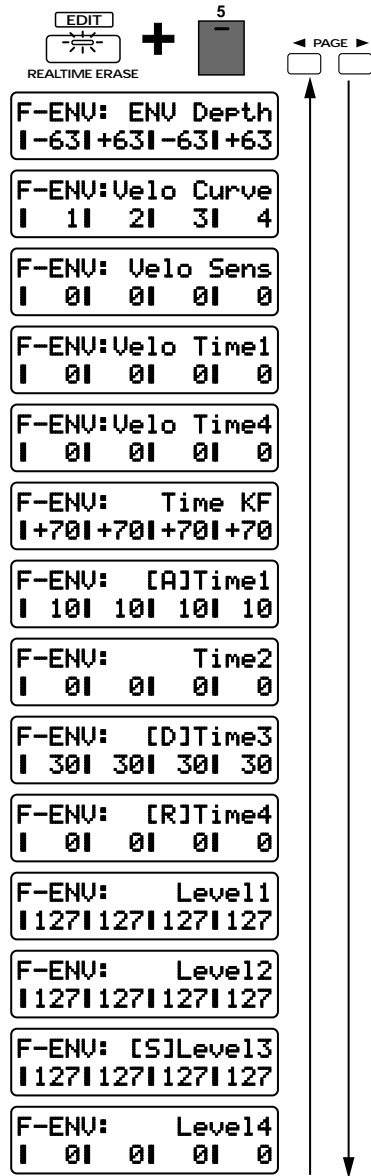

Velo Curve (Filter Envelope Velocity Curve)

Select the curve of change with which the force of your playing on the external MIDI keyboard will affect the amount of change produced by the filter envelope.

Range: 1-7

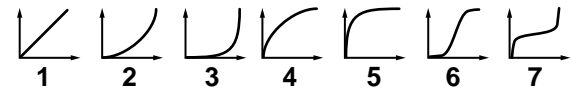

Velo Sens (Filter Envelope Velocity Sensitivity)

Specifies how the force of your playing on the external MIDI keyboard will affect the filter envelope.

Range: -100+150

With positive (+) settings, the tone will change more as you play more strongly on the keyboard. With negative (-) settings, the tone will change less as you play more strongly on the keyboard.

** It is not possible to control this by varying the force with which you press the keyboard pads.*

With positive (+) settings of Velocity Sensitivity, the sound will be brighter for strongly-played notes, and darker for softly-played notes.

The four front panel sliders [A]/[D]/[S]/[R] can be used to set the most commonly-used parameters of the filter envelope, but the MC-505 also allows you to make more detailed filter envelope settings.

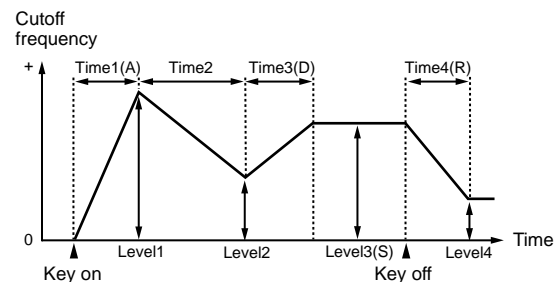

ENV Depth (Filter Envelope Depth)

This is the setting page for “Specifying the Depth of the Envelope (Filter Envelope Depth)” (p. 43).

Time1D4 (Filter Envelope Time 1D4)

Specifies the time until the next cutoff frequency is reached. You can set the four values Time1–4.

Range: 0–127

Higher settings will lengthen the time until the next cutoff frequency is reached.

* The front panel [A] (Attack Time) corresponds to Time1, [D] (Decay Time) to Time3, and [R] (Release Time) to Time4.

Level1D4 (Filter Envelope Level 1D4)

Specifies the cutoff frequency at each level. You can set the four values Level1–4.

Range: 0–127

Higher settings will also raise the cutoff frequency.

* The front panel [S] (Sustain Level) corresponds to Level3.

Velo Time1 (Filter Envelope Velocity Time 1 Sensitivity)

Specifies how the dynamics of your playing on the external MIDI keyboard will affect Time1.

Range: -100–+100

With positive (+) settings, Time1 will become faster as you play the keyboard more strongly. With negative (-) settings, Time1 will become slower as you play the keyboard more strongly.

* It is not possible to control this by varying the force with which you press the keyboard pads.

Velo Time4 (Filter Envelope Velocity Time 4 Sensitivity)

Specifies how the speed at which you release the external MIDI keyboard will affect Time 4.

Range: -100–+100

With positive (+) settings, Time4 will become faster as you release the keyboard more quickly. With negative (-) settings, Time4 will become slower as you release the keyboard more quickly.

* It is not possible to control this by varying the speed with which you release the keyboard pads.

Time KF (Filter Envelope Time Key Follow)

This setting causes the filter envelope times (Time 2/3/4) to be affected by the location of the keyboard pad that you press.

Relative to the envelope at the C4 note, higher settings of this parameter will cause the times to change more greatly.

Range: -100–+100

With positive (+) settings, the times will become shorter as you play higher notes. With negative (-) settings,

the times will become longer as you play higher notes.

For example, the notes of a piano change more rapidly in tone as their pitch rises (i.e., as you play up the keyboard). You can simulate this by setting Time Key Follow to a positive (+) setting.

Adjusting the Volume and Pan (Amplifier)

The AMP (amplifier) section contains settings related to the volume and the position of the sound on the stereo sound field.

Adjusting the Volume of Each Tone (Tone Level)

This setting adjusts the volume of each tone. This is used mainly to adjust the volume balance between tones.

1. Press [FUNC] to make the indicator blink.
2. Rotate the [TONE LEVEL] to adjust the Tone Level setting.

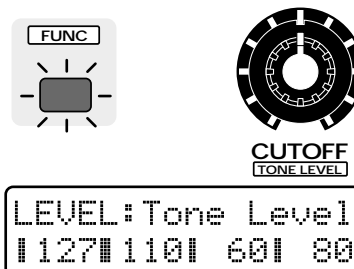

Range: 0–127

As the knob is rotated further clockwise, the volume will increase. As it is rotated counterclockwise, the volume will decrease.

* The overall volume of the entire patch can be modified and memorized for each pattern as the Setup parameter Part Level. The Tone Level setting will be multiplied by this value.



“Adjusting the Volume of Each Part (Part Level)” (p. 24)

Adjusting the Pan for Each Tone (Tone Pan)

This parameter sets the stereo location for each tone.

1. Press [FUNC] to make the indicator blink.
2. Rotate the [TONE PAN] knob to set the Tone Pan value.

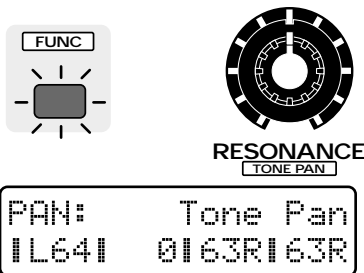

Range: L64–63R

As the knob is rotated further clockwise, the stereo location will shift toward the right. As it is rotated counterclockwise, the location will shift toward the left.

* The pan of the overall patch can be modified and set for each pattern by the Setup parameter Part Pan. The Tone Pan value will be added to this setting.

“Adjusting the Pan of Each Part (Part Pan)” (p. 24)

Causing Pan to Change Randomly (Random Pan Switch)

This setting causes the stereo location to change randomly each time a note is played.

1. Press [FUNC] to make the indicator blink.
 2. Press [RND PAN].
- All four indicators will be blinking, and the Random Pan Switch will be turned on.

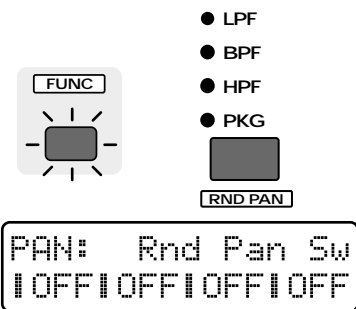

* The Tone Pan setting will be ignored by Tones for which the Random Pan Switch is turned on.

Making More Detailed Settings

Volume-related settings

1. Hold down [EDIT] and press keyboard pad [6].

The display will show the AMPLIFIER/LEVEL section setting page.

2. Use PAGE [<] [>] to select parameters within the section, and edit them.

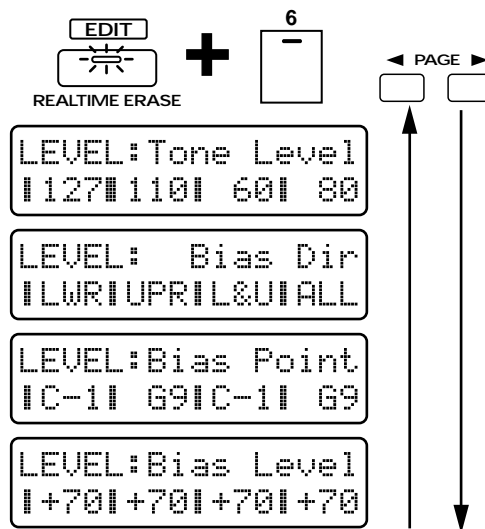

Tone Level

This is the setting page for “Adjusting the Volume of Each Tone (Tone Level)” (p. 45).

Bias

The Bias parameters specify how the keyboard position will affect the Tone Level. This can be used to simulate the way in which the volume of an acoustic instrument changes according to the location (pitch) of the note.

Bias Dir (Bias Direction)

Select the keyboard area(s) that will be affected above and/or below the specified Bias Point.

Available settings:

- LWR:** The volume will be modified for the keyboard area below the note specified as the Bias Point.
- UPR:** The volume will be modified for the keyboard area above the note specified as the Bias Point.
- L&U:** The volume will be modified symmetrically toward the left and right of the note specified as the Bias Point.
- ALL:** The volume will be modified linearly from the note specified as the Bias Point.

Bias Point

Specifies the key relative to which the volume will be modified.

Range: C-1–G9

Bias Level

Adjusts the slope of the volume change that will occur in the direction specified by Bias Direction.

Range: -100–+100

With positive (+) settings, the slope of volume change will increase in the positive (+) direction. With negative (-) settings, the slope of volume change will increase in the negative (-) direction.

* Even with positive (+) settings of this parameter, the volume cannot exceed the maximum level.

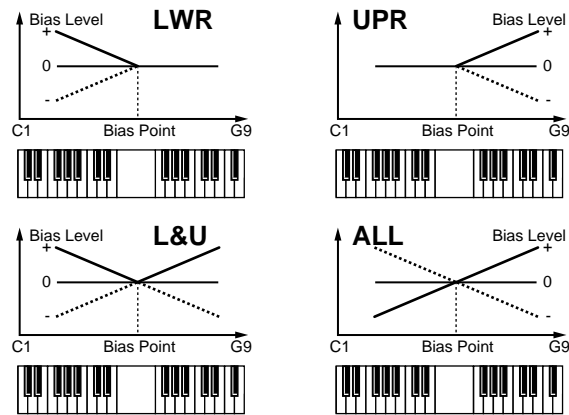

If you use two tones and set a Bias Direction of “UPR” for one and “LWR” for the other, the two tones will fade smoothly into each other as you play across the Bias Point. (This is known as “key crossfade.”)

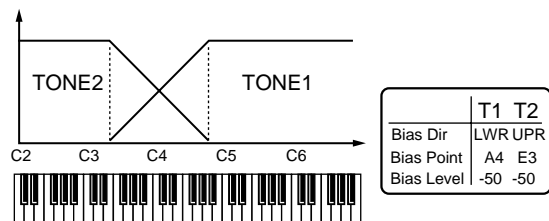

By setting Bias Direction to “L&U,” you can create sounds that are heard only in a specific area of the keyboard.

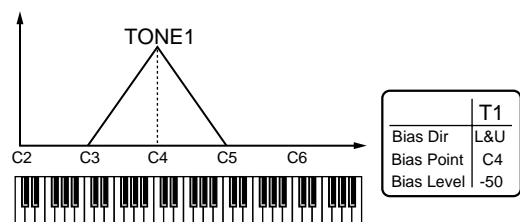

Pan-related settings

1. Hold down [EDIT] and press keyboard pad [7].

The display will show the AMPLIFIER/PAN section setting page.

2. Use PAGE [<] [>] to select parameters within the section, and edit them.

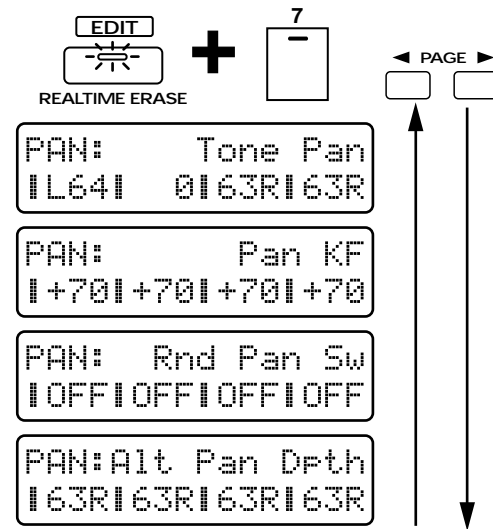

Tone Pan

This is the setting page for “Adjusting the pan for Each Tone (Tone Pan)” (p. 46).

Pan KF (Pan Key Follow)

This parameter causes the stereo location to change according to the keyboard pad that is played.

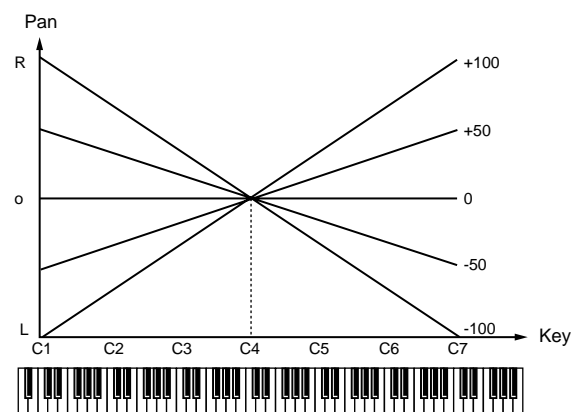

Range: -100–+100

With positive (+) settings, the sound will move toward the right as you play higher notes. With negative (-) settings, the sound will move toward the left as you play higher notes.

Rnd Pan Sw (Random Pan Switch)

This is the setting page for “Causing Pan to Change Randomly (Random Pan Switch)” (p. 46).

Alt Pan Dpth (Alternate Pan Depth)

This parameter causes the stereo location of the sound to alternate between left and right each time a note is played.

Range: L63–63R

When this parameter is set in the L direction, the sound will alternate in the order of left -> right-> left-> right. When set in the R direction, the sound will alternate in the order of right -> left-> right-> left. Higher settings will cause greater change.

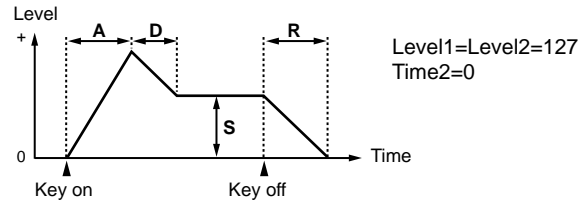
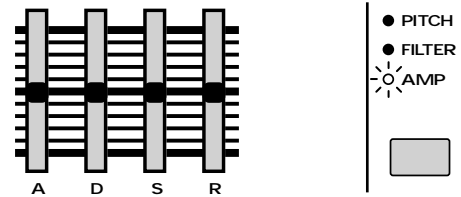

```
A-ENV: [A]Time1
| 20| 20| 20| 20

A-ENV: [D]Time3
| 20| 20| 20| 20

A-ENV: [S]Level3
|127|127|127|127

A-ENV: [R]Time4
| 40| 40| 40| 40
```

By using two tones and setting the Alternate Pan Depth of one to "L63" and of the other to "R63," you can make the two tones switch places alternately.

3

Creating Time-Variable Change in Volume (Amplifier Envelope)

On acoustic instruments, change in volume occurs over the duration of each note. For example, on a piano, the volume reaches the maximum level immediately, and then gradually decays to silence (decay-type instruments). On instruments such as an organ, the volume remains constant as long as the note is held (sustaining instruments). The parameters of the A-ENV (amplifier envelope) section let you specify this type of time-varying change in volume (the Amplifier Envelope).

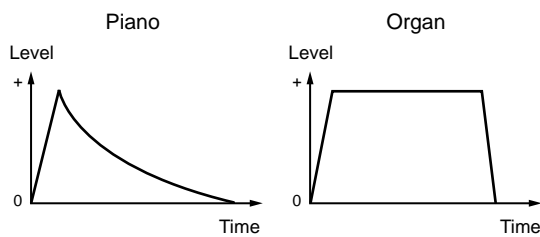

[A] (Attack Time)

The time from when the keyboard pad is pressed until the maximum volume is reached. Higher settings will cause the volume to change over a longer time.

[D] (Decay Time)

The time from when the maximum volume is reached until the Sustain Level is reached. Higher settings will cause the volume to change over a longer time.

[S] (Sustain Level)

The level at which the volume reaches a steady state. Higher settings will also raise the volume.

[R] (Release Time)

The time from when the keyboard pad is released until the volume decays to silence. Higher settings will cause the volume to change over a longer time.

Amplifier Envelope Settings

1. [ENV SELECT] several times to select AMP.
2. Use the [A]/[D]/[S]/[R] sliders to adjust the amplifier envelope values.

Range: 0–127

Making More Detailed Settings

1. Hold down [EDIT] and press keyboard pad [8].

The display will show the A-ENV section setting page.

2. Use PAGE [<] [>] to select parameters within the section, and edit them.

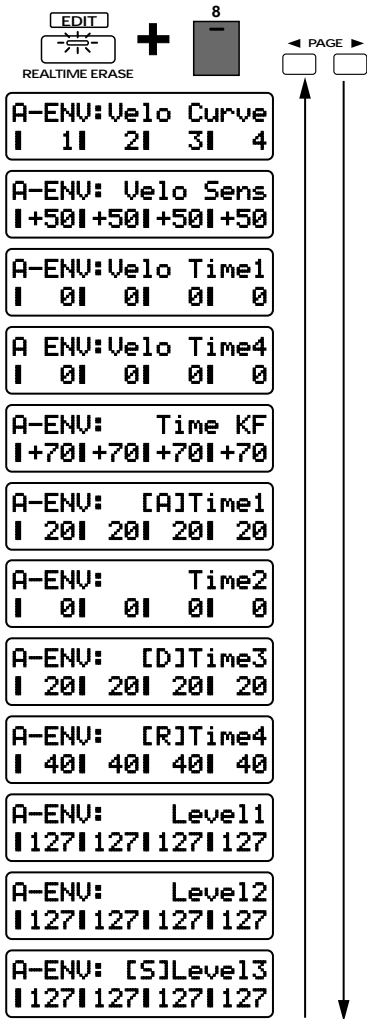

Velo Curve (Amplifier Envelope Velocity Curve)

Select the curve at which the strength of your playing on the external MIDI keyboard will affect the depth of the amplifier envelope.

Range: 1-7



Velo Sens (Amplifier Envelope Velocity Sensitivity)

Specifies how the depth of the amplifier envelope will be affected by the strength of your playing on the external MIDI keyboard.

Range: -100-+150

With positive (+) settings, the volume will increase as you play more strongly on the keyboard. With negative (-) settings, the volume will decrease as you play more strongly on the keyboard. If this is set to "0," the volume will not be affected by the strength of your playing on the keyboard.

* It is not possible to control this by varying the force with which you press the keyboard pads.

.....
If velocity sensitivity is set to a positive (+) value, the volume will be loud when you play strongly and soft when you play softly. As this value is increased, the volume difference between strongly played and softly played notes will gradually increase.
.....

The four front panel sliders [A]/[D]/[S]/[R] can be used to set the most common-used parameters of the amplifier envelope, but the MC-505 also allows you to make more detailed amplifier envelope settings.

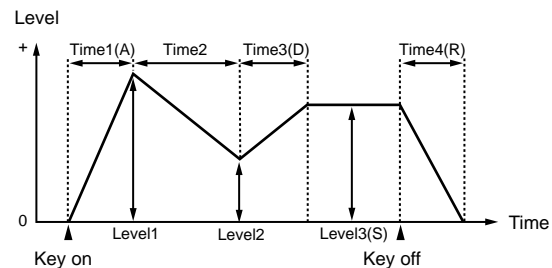

Time1D4 (Amplifier Envelope Time 1D4)

Specifies the time until the next level point is reached. This can be set for each of the four parameters Time 1-4.

Range: 0-127

Higher settings will lengthen the time until the next level point is reached.

* The front panel parameter [A] (Attack Time) corresponds to Time1, [D] (Decay Time) to Time3, and [R] (Release Time) to Time4.

Level1D3 (Amplifier Envelope Level 1D3)

These parameters specify the volume at each point. You can set the three points Level1-3.

Range: 0-127

Higher settings will also raise the volume.

* *The front panel [S] (Sustain Level) corresponds to Level3.*

Velo Time1 (Amplifier Envelope Velocity Time 1 Sensitivity)

Specifies how Time1 will be affected by the strength of your playing on the external MIDI keyboard.

Range: -100+100

With positive (+) settings, Time1 will become faster as you play the keyboard more strongly. With negative (-) settings, Time1 will become slower as you play the keyboard more strongly.

* *It is not possible to control this by varying the force with which you press the keyboard pads.*

By setting Velocity Time 1 Sensitivity to positive (+) settings you can create volume changes that will be appropriate for strings-type sounds. The volume attack will be gradual for softly-played notes, and faster for strongly-played notes.

Velo Time4 (Amplifier Envelope Velocity Time 4 Sensitivity)

Specifies how Time 4 will be affected by the speed at which you release the external MIDI keyboard.

Range: -100+100

With positive (+) settings, Time4 will become faster as you release the keyboard pads more quickly. With negative (-) settings, Time4 will become slower as you release the keyboard more quickly.

* *It is not possible to control this by varying the speed with which you release the keyboard pads.*

Time KF (Amplifier Envelope Time Key Follow)

This parameter specifies how the amplifier envelope times (Time2/3/4) will be affected by the keyboard pad location.

Relative to the envelope of the C4 note, higher settings of this parameter will cause greater change in envelope times.

Range: -100+100

With positive (+) settings, envelope times will become shorter as you play higher notes. With negative (-) settings, envelope times will become longer as you play higher notes.

On instruments such as a piano, the volume decays

more rapidly for higher notes. This can be simulated by setting Time Key Follow to positive (+) settings.

Delay Start

For example, by setting Level1 to "0" and adjusting Time1 [A] appropriately, you can create envelopes in which the sound does not begin until a certain time after the key is pressed.

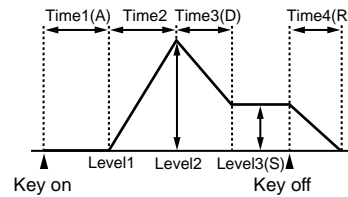

Applying Cyclic Changes to the Sound (LFO)

The LFO (Low Frequency Oscillator) applies cyclic change to the sound. The MC-505 has two LFOs (LFO1/LFO2), and each of these can be used to modify the pitch, cutoff frequency or volume of each tone to create effects such as vibrato, wah and tremolo. Since both LFOs have the same parameters, the following explanation will cover both of them.

Selecting the Waveform That Will Modulate the Sound (LFO1 Waveform)

Select the output waveform for LFO1. The sound will be modulated in the same shape as the selected waveform.

1. Press [WAVEFORM] several times to select the waveform.

When the waveform at the left is selected, the indicator will light. When the waveform at the right is selected, the indicator will begin blinking.

lit	blink
● TRI	● TRP
● SIN	● S&H
● SAW	● RND
● SQR	● CHS

LFO1: Waveform
| TRI | SIN | SAW | SQR

Available settings:

TRI (triangle):

The sound will be modulated continuously. This is a frequently-used waveform, and is suited for effects such as vibrato.

SIN (sine wave):

The sound will be modulated smoothly.

SAW (sawtooth wave):

When the sound reaches the upper value, it will return to the original position and begin rising again.

SQR (square wave):

The sound will be modulated as if it were being switched between two positions.

TRP (trapezoid wave):

The sound will be modulated as if it were being switched between two positions. The curve at the transitions differs from square wave.

S&H (sample & hold):

This setting causes the sound to change unpredictably, and is suitable for creating sound effects.

RND (random):

This setting causes the sound to change unpredictably, and is suitable for creating sound effects.

CHS (chaos):

This setting causes the sound to change unpredictably without regard to frequency, and is suitable for creating sound effects.

* When CHS (chaos) is selected, the LFO rate setting will be ignored.

Adjusting the Speed of Modulation (LFO1 Rate)

Here's how to adjust the modulation speed of LFO1.

1. Press [FUNC] to make the indicator blink.
2. Rotate the [RATE] knob to adjust the LFO1 rate.

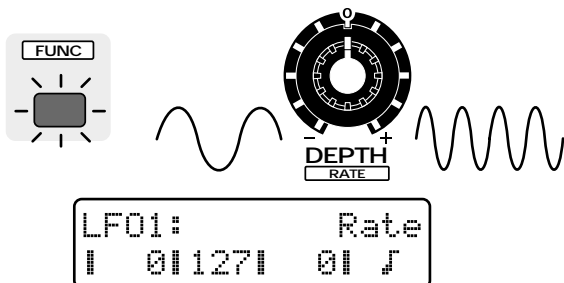

Range: 0-127

As the knob is rotated further clockwise, the sound will be modulated more rapidly. As the knob is rotated further counterclockwise, the sound will be modulated more slowly.

When LFO Tempo Sync (p. 53) is "ON," you can specify this parameter in terms of a note value.

Range:

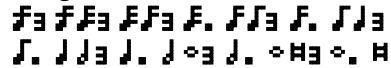

At this time, rotating the knob toward the right will cause the sound to be modulated more slowly.

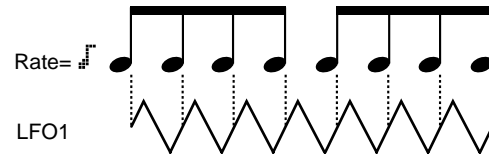

* LFO Rate settings are common to PITCH (pitch), FILTER (brightness) and AMP (volume). The rate cannot be set independently for these three.

Adjusting the Depth of Modulation (LFO1 Depth)

For each parameter, you can adjust the depth of the LFO effect.

Range: -63+63

Increasing this value in the positive (+) direction will create increasingly greater change. Increasing this value in the negative (-) direction will invert the waveform, causing the change to occur in the opposite direction.

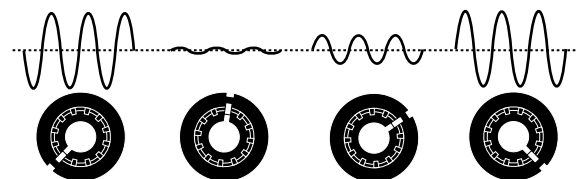

Adjusting the depth of pitch modulation (LFO1 Pitch Depth)

By cyclically modulating the pitch you can create a vibrato effect.

1. Make sure that the [FUNC] indicator is dark.
2. Press [ENV SELECT] several times to select PITCH.
3. Rotate the [DEPTH] knob to adjust the vibrato depth.

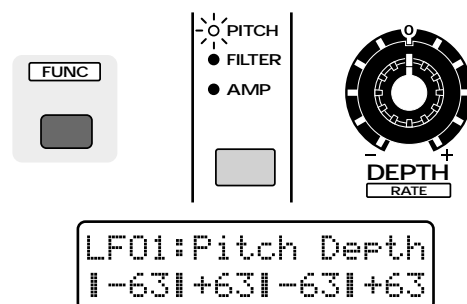

Adjusting the depth of cutoff frequency modulation (LFO1 Filter Depth)

By cyclically modulating the cutoff frequency you can create a wah effect.

1. Make sure that the [FUNC] indicator is dark.
2. Press [ENV SELECT] several times to select FILTER.
3. Rotate the [DEPTH] knob to adjust the wah depth.

3

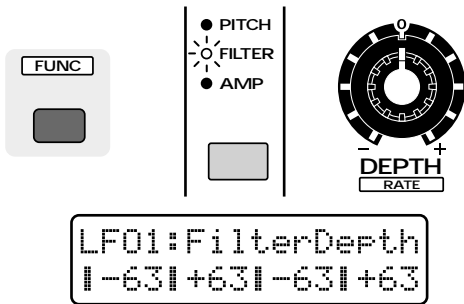

Adjusting the depth of volume modulation (LFO1 Amplifier Depth)

By cyclically modulating the volume you can create a tremolo effect.

1. Make sure that the [FUNC] indicator is dark.
2. Press [ENV SELECT] several times to select AMP.
3. Rotate the [DEPTH] knob to adjust the tremolo depth.

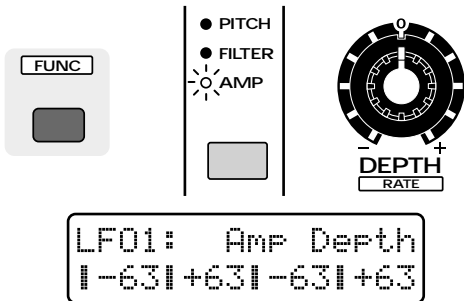

* The LFO2 parameters cannot be edited using [WAVEFORM], the [RATE] knob or the [DEPTH] knob.

Making More Detailed Settings

1. Hold down [EDIT] and press keyboard pad [9] or [10].
The display will show the LFO1 or LFO2 section setting page.
2. Use PAGE [<] [>] to select parameters within the section, and edit them.

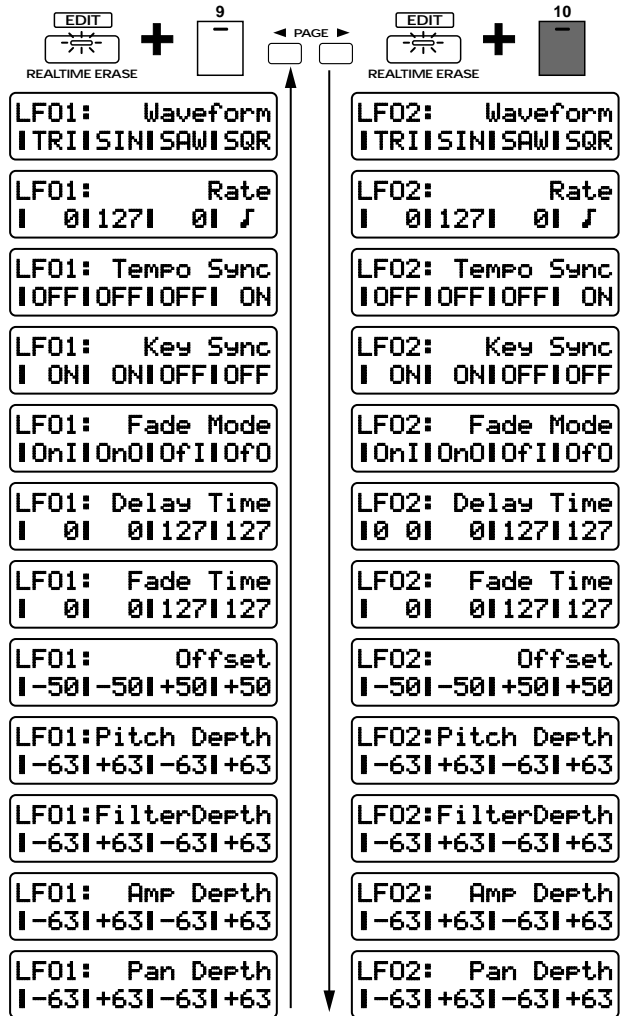

Waveform (LFO1/LFO2 Waveform)

This is the setting page for “Selecting the Waveform That Will Modulate the Sound (LFO1 Waveform)” (p. 50).

Rate (LFO1/LFO2 Rate)

This is the setting page for “Adjusting the Speed of Modulation (LFO1 Rate)” (p. 51).

Tempo Sync (LFO1/LFO2 Tempo Sync)

This parameter synchronizes the LFO modulation frequency to the tempo of the pattern.

Available settings:

ON: The modulation speed will be synchronized to the tempo, and the LFO Rate parameter can be set in terms of a note value.

OFF: The modulation speed will be determined by the LFO Rate setting, regardless of the tempo.

Key Sync (LFO1/LFO2 Key Sync)

This parameter synchronizes the LFO cycle to the timing at which the keyboard pads are played.

Available settings:

ON: The LFO cycle will begin when the keyboard is played.

OFF: The same LFO waveform will be output regardless of the timing at which the keyboard is played.

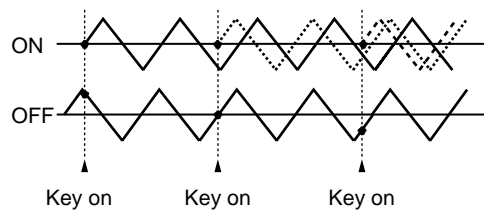

When Key Sync is on, the LFO waveform will begin for each note when it is played, producing a spacious sound with a sense of movement. When Key Sync is off, a single LFO waveform will be applied to all notes, producing a unified sound. When you wish to emphasize the effect (vibrato etc.), you may want to turn this parameter off. Also, when Tempo Sync is on, leaving Key Sync off will allow you to synchronize precisely to the tempo of the pattern.

Fade Mode (LFO1/LFO2 Fade Mode)

Select the way in which the LFO effect will be applied.

Available settings:

OnI (On-In): The effect will be applied gradually, after the keyboard pad is pressed.

OnO (On-OUT): The effect will be applied immediately when the keyboard pad is pressed, and will gradually disappear.

OfI (Off-In): The effect will be applied gradually, starting when the keyboard pad is released.

OfO (Off-Out): The effect will be applied while the keyboard pad remains pressed, and will gradually disappear after it is released.

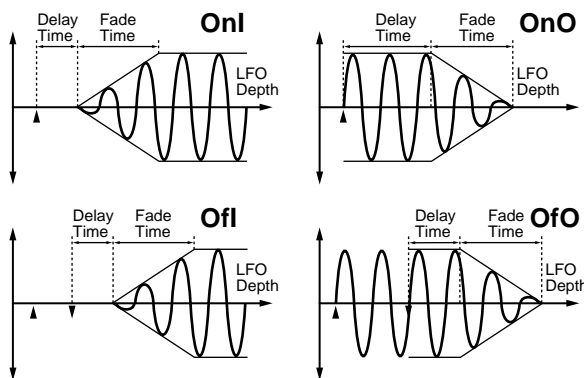

Delay Time (LFO1/LFO2 Delay Time)

Depending on the Fade Mode setting, specify the time over which the LFO will be applied or the time over which it will continue, etc.

Range: 0-127

Higher settings will produce longer times.

Fade Mode settings

OnI: Specifies the time from when the keyboard pad is pressed until the LFO begins to be applied.

OnO: Specifies the time that the LFO will continue after the keyboard pad is pressed.

OfI: Specifies the time from when the keyboard pad is released until the LFO begins to be applied.

OfO: Specifies the time that the LFO will continue after the keyboard pad is released.

Refer to the diagrams for Fade Mode.

Fade Time (LFO1/LFO2 Fade Time)

Specifies the time over which the LFO amplitude will reach the maximum (minimum) after the Delay Time has elapsed.

Range: 0-127

Higher settings will produce longer times.

Refer to the diagrams for Fade Mode.

Offset (LFO1/LFO2 Level Offset)

This parameter offsets the LFO waveform upward or downward from the central value (pitch or cutoff frequency, etc.).

Range: -63+63

As this value is increased in the positive (+) direction, the waveform will be moved upward from the central value. As this value is increased in the negative (-) direction, the waveform will be moved downward from the central value.



Pitch Depth (LFO1/LFO2 Pitch Depth)

This is the setting page for “Adjusting the depth of pitch modulation (LFO1 Pitch Depth)” (p. 51).

Filter Depth (LFO1/LFO2 Filter Depth)

This is the setting page for “Adjusting the depth of cutoff frequency modulation (LFO1 Filter Depth)” (p. 52).

Amp Depth (LFO1/LFO2 Amplifier Depth)

This is the setting page for “Adjusting the depth of volume modulation (LFO1 Amplifier Depth)” (p. 52).

3

Pan Depth (LFO1/LFO2 Pan Depth)

Adjusts the effect that the LFO will have on pan (stereo location).

Range: -63+63

As this value is increased in the positive (+) direction, the LFO will have a greater effect on pan. Negative (-) settings will invert the LFO waveform, causing the pan to change in the opposite direction.

By giving two tones the same rate setting and setting their Pitch Depth to “+30” and “-30” respectively to apply opposite-phase LFO, you can create a vibrato effect in which the pitches change in opposite directions.

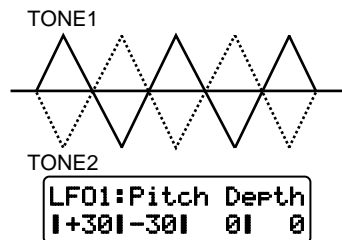

Common Settings

Here you can make settings that are common to the entire patch.

Changing How Tones Are Combined and Played (Common)

In the COMMON section you can make settings that specify how the tones are combined and how the patch will be played, etc.

1. Hold down [EDIT] and press keyboard pad [11].

The display will show the COMMON section setting page.

2. Use PAGE [<] [>] to select parameters within the section, and edit them.

Struct 1&2/3&4 (Structure Type)

Specifies how tones 1 and 2 will be combined (Struct 1&2), and how tones 3 and 4 will be combined (Struct 3&4).

Abbreviations shown for each type have the following meanings.

- W/P: Wave/Pitch
- FILTER: Filter
- AMP: Amplifier
- B: Booster
- R: Ring Modulator

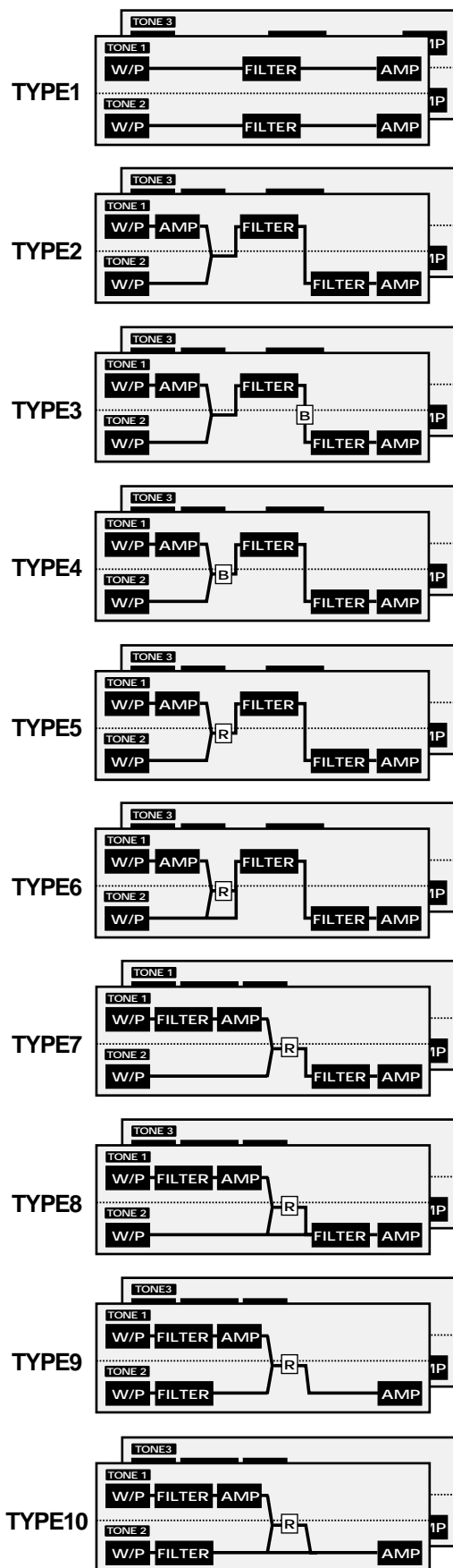

TYPE 1: This is the most basic type. Tones 1 and 2 (3 and 4) are independent. Select this when you wish to utilize the waveform of each tone without change, or when you wish to layer tones to create a richer sound.

TYPE 2: This type combines the two filters to strengthen their characteristics. The AMP of tone 1 (3) will control the volume balance of the two tones.

TYPE 3: This type mixes the sound of tone 1 (3) and tone 2 (4), applies a filter, and then applies a booster to distort the waveform.

TYPE 4: This type applies a booster to distort the waveform, and then combines the two filters. The AMP of tone 1 (3) adjusts the depth of the booster.

TYPE 5: This type uses a ring modulator to create new overtones, and combines the two filters. The AMP of tone 1 (3) adjusts the depth of ring modulation.

TYPE 6: This type uses a ring modulator to create new overtones, and in addition mixes in the sound of tone 2 (4) and stacks the two filters. The AMP of tone 1 (3) adjusts the depth of ring modulation.

TYPE 7: This type applies a filter to tone 1 (3) and ring-modulates it with tone 2 (4) to create new overtones.

TYPE 8: This type applies a filter to tone 1 (3) and ring-modulates it with tone 2 (4), and mixes the result with the filtered sound of tone 2 (4).

TYPE 9: This type passes the filtered sound of each tone through a ring modulator to create new overtones.

TYPE 10: This type passes the filtered sound of each tone through a ring modulator to create new overtones, and also mixes in the sound of tone 2 (4).

* With TYPE 2-10 selected, turning off one of the paired tones will cause the other tone to sound as TYPE 1.

Booster 1&2/3&4 (Booster Gain)

When a Structure Type of "TYPE3" or "TYPE4" is selected, you can adjust the depth of the booster.

This can be set for the pair of tones 1 and 2 (Booster 1&2) and for the pair of tones 3 and 4 (Booster 3&4).

Range: 0, +6, +12, +18

Higher settings will produce greater distortion.

Booster

The Booster is a function that increases the input signal in order to distort it.

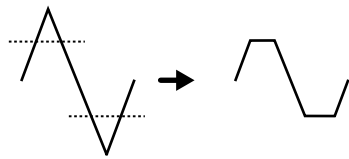

In addition to using this for distortion, you can use the waveform of one of the tones as an LFO to shift the other waveform up and down, producing an effect similar to PWM (Pulse Width Modulation). This is even more effective when used in conjunction with the Wave Gain of the WAVE/FXM section.

"Wave Gain" (p. 35)

Use WG1 as the LFO Adjust the output of WG1

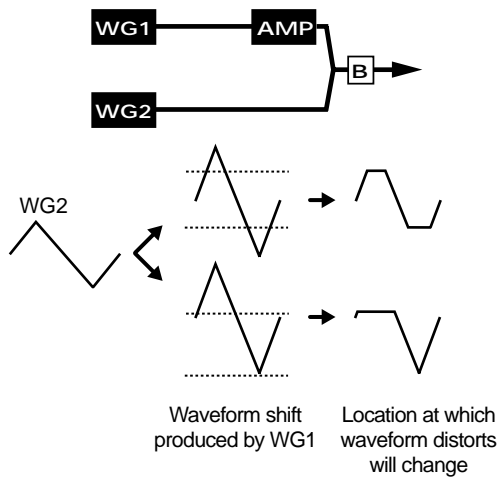

Ring Modulator

The ring modulator multiplies the waveforms of two tones to create many new overtones that were not present in either of the original waveforms (inharmonic overtones). This is suitable for creating unpitched metallic sounds such as bells.

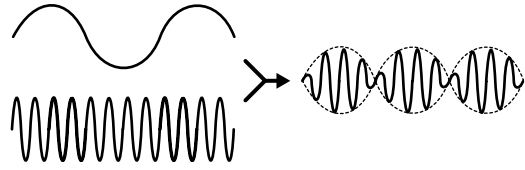

Stretch Tune (Stretch Tuning Depth)

Select the stretch tuning curve. The selected curve will affect the way that chords will sound.

Range: OFF, 1-3

When this is "OFF," equal temperament will be used. As the value is increased, the pitch difference between the high range and low range will increase.

Stretch Tuning

Stretch Tuning is a method of tuning used only on pianos. In general, pianos are tuned so that their high range is sharper and their low range is flatter than the equal tempered pitch. This makes chords sound better.

V-Priority (Voice Priority)

Specifies how notes will be prioritized when the maximum simultaneous polyphony (64 notes) is exceeded.

Available settings:

LAST: The last-played notes will take priority. If more than 64 notes are played, the first-played notes will be turned off successively.

LOUDEST: The loudest notes will take priority. If more than 64 notes are played, the notes with the lowest volume will be turned off successively.

Key Range L (Key Range Lower)

Specifies the lowest note that the tone will sound.

If a note below this setting is played, it will not sound.

Range: C-1-UPR

Key Range U (Key Range Upper)

Specifies the highest note that the tone will sound.

If a note above this setting is played, it will not sound.

Range: LWR-G9

By using Key Range Lower and Key Range Upper, you can cause different tones to sound in different areas of the keyboard.

3

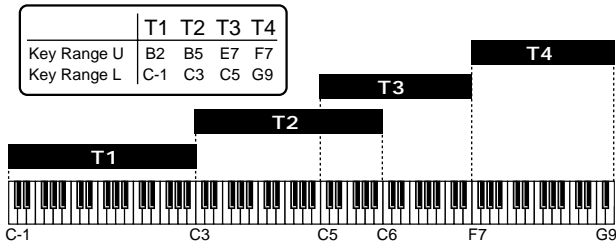

* It is not possible to set the Lower value above the Upper, or the Upper below the Lower.

Velo Range (Velocity Range Switch)

Specifies whether or not the Velocity Range settings will be enabled. By using velocity range settings, you can cause different tones to sound in response to notes played at different strengths on the external MIDI keyboard.

Range: OFF, ON

When this setting is "ON," the Velocity Range settings will be used.

* It is not possible to control this by varying the force with which you press the keyboard pads.

Velo Range L (Velocity Range Lower)

Specifies the lower velocity limit for which the tone will sound.

The tone will not be sounded by notes played with a velocity lower than this setting.

Range: 1-UPR

Velo Range U (Velocity Range Upper)

Specifies the upper velocity limit for which the tone will sound.

The tone will not be sounded by notes played with a velocity stronger than this setting.

Range: LWR-127

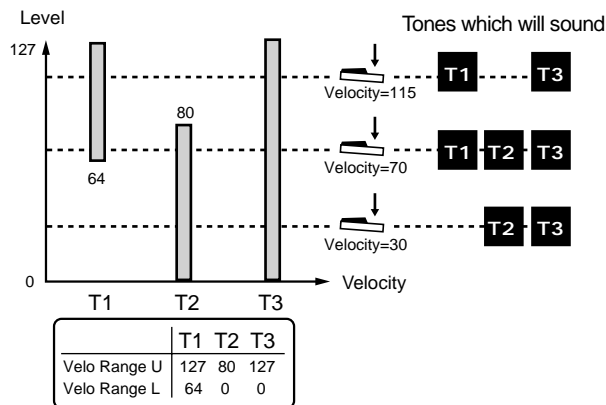

* It is not possible to set the Lower value above the Upper, or the Upper below the Lower.

Velo X-Fade (Velocity Crossfade)

Specifies the way in which the volume will change when a keyboard is played with a velocity that falls outside the velocity range setting.

Range: 0-127

Higher settings will cause the volume to decrease more gradually when the velocity falls outside of the velocity range.

By using Velocity Crossfade, you can use playing dynamics on the keyboard to smoothly connect two tones.

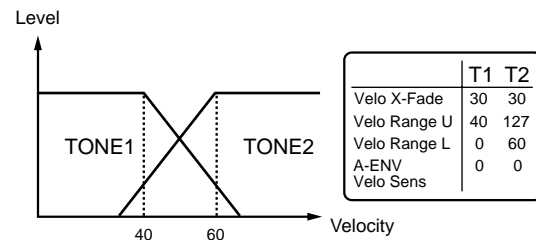

Smoothly Changing the Pitch (Portamento)

In the SOLO/PORTA (Solo/Portamento) section you can make settings for playing a patch monophonically, or to apply a portamento effect.

Portamento

Portamento is a function that smoothly connects the pitch of one note to the next. When the Solo switch is on, you can apply portamento to simulate the slide performance technique sometimes used on instruments such as violin.

Turning portamento on/off (Portamento Switch)

Turn this on when you wish to use portamento.

1. Press PORTAMENTO [ON].

The indicator will light, and portamento will be turned on.

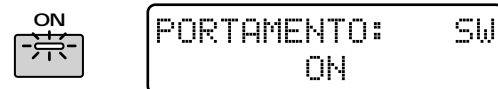

Adjusting the time over which the pitch will change (Portamento Time)

You can adjust the time over which the pitch will change when portamento is used.

1. Rotate the **PORTAMENTO [TIME]** knob to set the portamento time value.

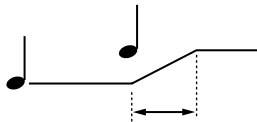

3

```
PORTAMENTO: Time
           64
```

Range: 0–127

As the knob is rotated further clockwise, the pitch will take a longer time to reach the next note. As the knob is rotated counterclockwise, the pitch of the next note will be reached more quickly.

Playing Monophonically (Solo Switch)

By turning on the Solo switch, you can play monophonically (one note at a time). It is effective to turn Solo on when playing synth lead or synth bass sounds.

1. Press **[SOLO]**.

The indicator will light, and Solo will be on.



```
SOLO: Solo SW
      ON
```

Making More Detailed Settings (SOLO/PORTA Section)

1. Hold down **[EDIT]** and press keyboard pad **[12]**.

The display will show the SOLO/PORTA section setting page.

2. Use **PAGE [<] [>]** to select parameters within the section, and edit them.

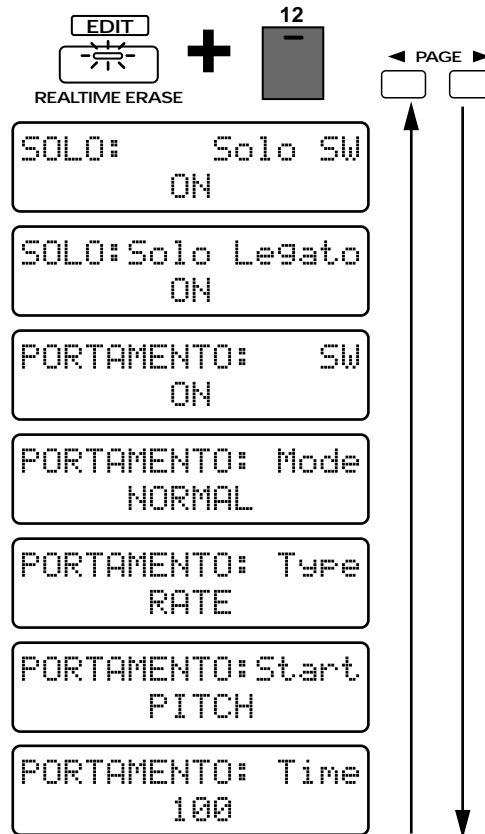

Solo SW (Solo Switch)

This is the setting page for “Playing Monophonically (Solo Switch).”

Solo Legato (Solo Legato Switch)

Solo Legato is a function that can be applied when the Solo Switch is on. When Solo Legato is on, playing a note while the previous note is still held will cause only the pitch to change, without generating a new attack. This creates a smooth transition between notes, which is effective when you wish to simulate the hammering-on and pulling-off techniques used by a guitarist.

Range: OFF, ON

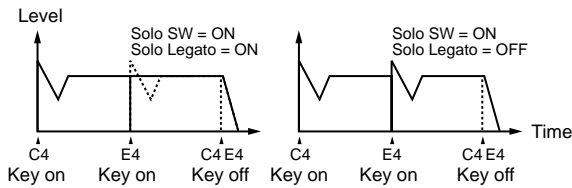

Portamento SW (Portamento Switch)

This is the setting page for “Turning portamento on/off (Portamento Switch)” (p. 57).

Portamento Mode

Select the performance technique by which portamento will be applied.

Available settings:

NORMAL: Portamento will always be applied.

LEGATO: Portamento will be applied for notes played legato (i.e., notes played before the previous note is released).

Portamento Type

Select the type of the portamento effect.

Available settings:

RATE: The time over which the pitch change occurs will depend on the distance between the two pitches.

TIME: The pitch change will occur over a fixed time, regardless of the distance between pitches.

Portamento Start (Portamento Start Pitch)

When portamento is on, pressing another keyboard pad during the pitch change will cause a new pitch change to begin. This parameter specifies the pitch at which the change will begin.

Available settings:

PITCH: When another key is pressed while the pitch is changing, the new portamento movement will begin from the pitch at that moment.

NOTE: The new portamento movement will begin from the pitch toward which it had been moving.

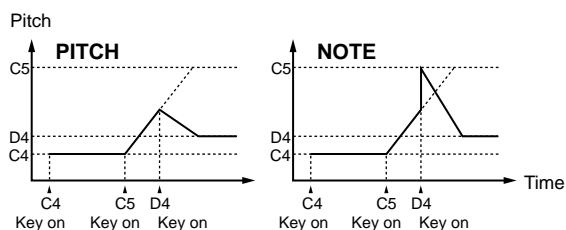

Portamento Time

This is the setting page for “Adjusting the time over which the pitch will change (Portamento Time)” (p. 58).

Specifying the Parameters That Will Be Modified by Each Controller (Control)

These settings determine how the controllers (pitch bend lever, modulation lever, keyboard aftertouch) of external MIDI devices will control the patch parameters etc. of the MC-505.

These settings are divided into three sections by controller.

Modulation Lever

This controller is used to apply vibrato or add various effects.

This setting is made in the CONTROL-MOD (Control Modulation) section.

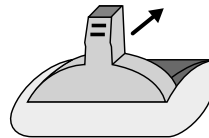

Pitch Bend Lever

This controller is normally used to control the pitch. This setting is made in the CONTROL-PITCH BEND (Control Pitch Bend) section.

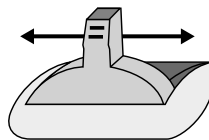

Aftertouch

Pressure applied to the keyboard can be used to control various parameters.

This setting is made in the CONTROL-AFTER TOUCH (Control Aftertouch) section.



* If the connected MIDI device does not support aftertouch, aftertouch cannot be used to control parameters.

1. Hold down [EDIT] and press a keyboard pad [13], [14] or [15].

[13]: The CONTROL/MOD section setting page will appear, and you can make settings for the parameter that will be controlled by the modulation lever.

[14]: The CONTROL/PITCH BEND section setting page will appear, and you can make settings for the parameter that will be controlled by the pitch bend lever.

[15]: The CONTROL/AFTER TOUCH section setting page will appear, and you can make settings for the parameter that will be controlled by after-touch.

2. Use PAGE [<] [>] to select parameters within the section, and edit them.

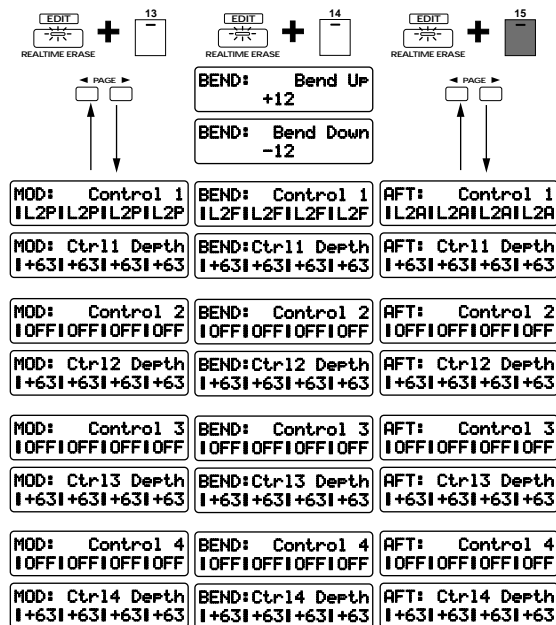

Adjusting the Range of Pitch Bend (Bend Range) (PITCH BEND Section Only)

Bend Up/Down (Bend Range Up/Down)

Specifies the amount of pitch change (in semitone units) that will occur when the pitch bend lever of an external MIDI device is operated. You can make independent settings for movement to the right (raising the pitch) and left (lowering the pitch).

Available settings:

Bend Range Up: 0—+12

Bend Range Down: 0—48

Higher settings will result in a greater pitch change when the pitch bend lever is moved to the left or right.

For example, if Bend Range Up is set to “+12,” the pitch will rise one octave when the pitch bend lever is moved to the right-most position.

Control 1/2/3/4 (Control Destination 1/2/3/4)

Select the parameters that will be controlled when each controller of the external MIDI device is operated. For each controller, you can assign up to four parameters for each tone (Control 1 through Control 4).

Available settings:

OFF: No control

PCH: Pitch

CUT: Cutoff Frequency (p. 40)

RES: Resonance (p. 41)

LEV: Tone Level (p. 45)

PAN: Tone Pan (p. 46)

L1P: LFO1 Pitch Depth (Vibrato) (p. 54)

L2P: LFO2 Pitch Depth (Vibrato) (p. 54)

L1F: LFO1 Filter Depth (Wah) (p. 54)

L2F: LFO2 Filter Depth (Wah) (p. 54)

L1A: LFO1 Amplifier Depth (Tremolo) (p. 54)

L2A: LFO2 Amplifier Depth (Tremolo) (p. 54)

L1p: LFO1 Pan Depth (p. 54)

L2p: LFO2 Pan Depth (p. 54)

L1R: LFO1 Rate (p. 52)

L2R: LFO2 Rate (p. 52)

Ctrl 1/2/3/4 Depth (Control 1/2/3/4 Depth)

Specifies the amount of change that will occur for each parameter selected as a control destination.

Range: -63—+63

With positive (+) settings, higher values will allow greater control.

With negative (-) settings, the direction of the change will be inverted.

* Parameters that are modified using controllers are modified only temporarily. The value of the parameter itself is not directly changed.

.....
Example of settings

Using LFO2 to apply vibrato controlled by the modulation lever

```
MOD: Control 1 | MOD: Ctr11 Depth
|L2P|L2P|L2P|L2P | | +63|+63|+63|+63
```

For each tone, set the LFO2 Pitch Depth to “0,” and the LFO2 Rate to approximately “90” (p. 54, 52).

Using the modulation lever to change the cutoff frequency

```
MOD: Control 1 | MOD: Ctr11 Depth
|CUT|CUT|CUT|CUT | | +63|+63|+63|+63
```

Set the cutoff frequency of each tone to approximately “60” (p. 40).

Using the pitch bend lever to change the panning

```
BEND: Control 1 | BEND: Ctr11 Depth
|PAN|PAN|PAN|PAN | | +63|-63|+63|-63
```

For each tone, set the Tone Pan to “0,” and the Bend Range Up/Down to “0” (p. 46, 60).

Using aftertouch to bend down

```
AFT: Control 1 | AFT: Ctr11 Depth
|PCH|PCH|PCH|PCH | | -63|-63|-63|-63
```

Set the Bend Range Down to “-48” (p. 60).

Saving Patches You’ve Created (Patch Write)

After you’ve created a patch you like, do this to save it as a User Patch:

1. Make sure the pattern is stopped.
2. Press [PATCH] to access the Patch Select page.

If you’ve modified the patch settings, an asterisk “*” will be displayed at the left of the number, indicating that the selected patch has been modified (edited). Be aware that if you select a different patch without saving the modified patch, your changes will be lost.

3. Press [WRITE].

The following display will appear, and the “_” (cursor) will appear under the number.



```
PATCH-Wte U:A001
Lead TB 1
```

If you do not wish to change the number or name, you can omit steps 4–8.

If you decide not to save the patch, press [EXIT].

4. Press [USER] or [CARD] to select the save destination bank.

* CARD banks can be selected only if an optional memory card is inserted.

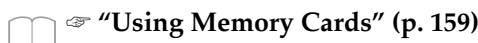

5. Use [INC] [DEC] or the [VALUE] dial to select the save destination number.

3

.....
 At this time, you can press [UNDO/REDO] to check the name of the patch that is currently in the save destination number. After you have found a patch that you do not mind overwriting, press [UNDO/REDO] once again to return to the previous display.

6. Press PAGE [>].

The cursor will move to the beginning of the second line in the display.

```
PATCH-Wte U:A001
Lead TB 1
```

7. Assign a name to the patch.

Use [INC] [DEC] or the [VALUE] dial to specify the character.

The following characters can be selected:
 Space, A–Z, a–z, 0–9, ! “ # \$ % & ‘ () * +, - . / : ; < = > ?
 @ [¥] ^ _ ` { | }

8. Repeat steps 6D7 to input the name.

By pressing PAGE [<] you can move the cursor back toward the left.

A name of up to 12 characters can be input.

9. Press [ENTER].

The confirmation screen will appear in the display. If you decide to cancel the operation, press [EXIT].

```
PATCH-Wte U:A001
Are You Sure ?
```

10. Press [ENTER] once again.



The Patch Write operation will be carried out, then the normal display will reappear. The patch has now been saved.

Copying and Initializing Settings

Patch Tone Copy

This operation copies the settings of a tone in a patch to the specified tone of the currently-selected patch.

3

1. Select any part 1D7 as the current part.
2. Press [PATCH] to access the patch select page.
3. Select the copy destination patch.
4. Hold down [SHIFT] and press [PARAM COPY].

The display will show the copy source patch, the copy source tone and the copy destination tone.

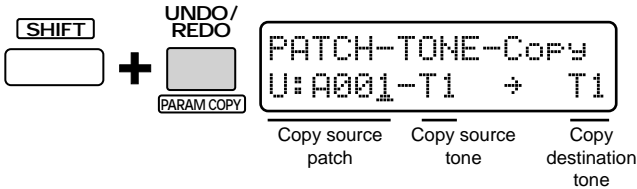

5. Use [INC] [DEC] or the [VALUE] dial to specify the copy source patch, the copy source tone and the copy destination tone.

You can use PAGE [<] [>] to move the cursor.

6. Press [ENTER].

The confirmation screen will appear in the display.

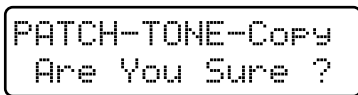

7. Press [ENTER] once again.

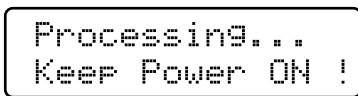

The Patch Tone Copy operation will be carried out, then the normal display will reappear. If you decide to cancel the operation, press [EXIT].

If you wish to save the patch that you copied, use the Patch Write operation.

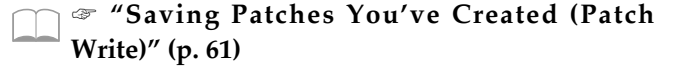

Patch Initialize

This operation initializes a patch.

1. Press [PATCH] to access the patch select page.
2. Select the patch that you wish to initialize.
3. Hold down [SHIFT] and press [INITIALIZE]. The confirmation screen will appear in the display. If you decide to cancel the operation, press [EXIT].



4. Press [ENTER].

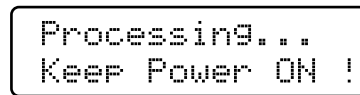

The Patch Initialize operation will be carried out, then the normal display will reappear.

Creating an Original Rhythm Set

Creating the Sounds

In Rhythm Edit, you can modify the parameters of each rhythm tone independently.

1. Select the rhythm part as the current part.
2. Select the rhythm set that you wish to edit (p. 23).
3. Press [TONE SELECT] to make the indicator light.

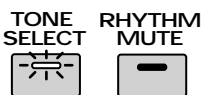

4. Press [EDIT].

The indicator will light. The display will show the currently selected rhythm set parameter, and the name and note number of the rhythm tone currently being edited.

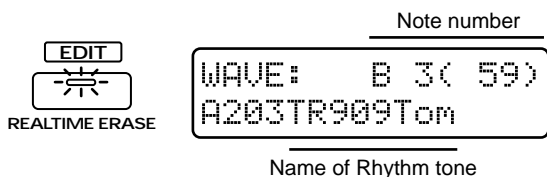

5. Press a keyboard pad to select the rhythm tone that you wish to edit.

The last-played rhythm tone will be selected for editing.

6. Select the rhythm set parameter that you wish to modify, and edit the value.

To exit from an editing page, press [EXIT]. There are two ways to select rhythm set parameters.

Using knobs and buttons to select the page for editing

By operating the knobs or buttons of the front panel, you can directly call up the editing page for that parameter. For example, if you operate [CUTOFF] knob, the display will automatically change to the cutoff frequency setting page, and you can view the settings for each rhythm tone as you modify them.

* This method cannot be used to edit parameters for which there is no front panel knob or button.

Selecting only the edit page without modifying the value

If you wish to see the current value before you modify it, hold down [EDIT] while you operate the knob. This will access the editing page without modifying the value.

Selecting pages in each section for editing

By pressing [EDIT] + a keyboard pad, you can access the pages for each section, then use PAGE [<] [>] to move between parameter screens within each section, and edit the desired parameter. This method allows you to edit all parameters, and is suitable when you wish to edit a sound in a logical sequence such as "waveform" -> "pitch" -> "brightness," etc.

To modify the value, use [INC] [DEC] or the [VALUE] dial.

For how to access the pages of each section, refer to "Making More Detailed Settings" in each section.

3

Specifying the Basic Waveform of the Sound and How It Will Sound (Wave)

In the WAVE section you can specify the waveform that will be the basis of the sound, and how it will sound.

Selecting the Basic Waveform (Wave Select)

Select the waveform that will be the basis of each rhythm tone.

1. Press [WAVE SELECT].

The indicator will light, and the wave select setting page will appear.

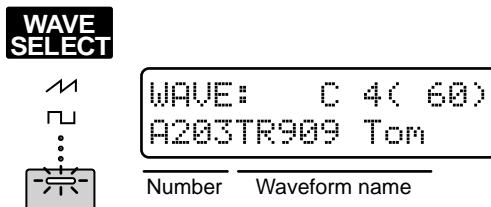

2. Use [INC] [DEC] or the [VALUE] dial to select a Waveform Number (A001DA254, B001DB251).

If you would like to know what waveforms are available...

☞ "Waveform List" (p. 190)

Making More Detailed Settings

1. Hold down [EDIT] and press keyboard pad [1].

The display will show the WAVE section setting page.

2. Use PAGE [<] [>] to select parameters within the section, and edit them.

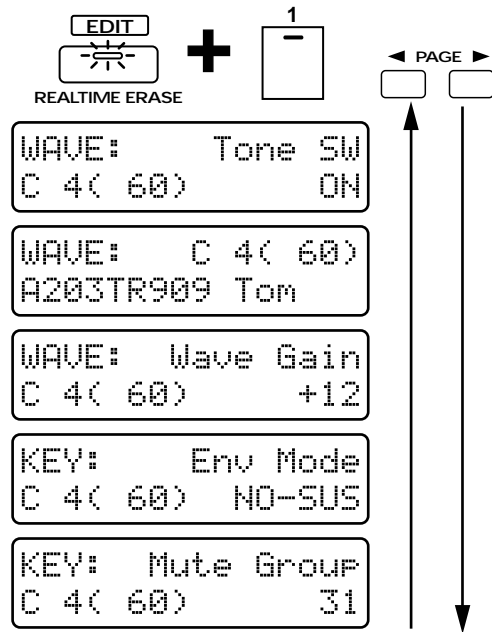

Tone SW (Rhythm Tone Switch)

Turn this “ON” if you want the rhythm tone to sound, or “OFF” if you do not want it to sound.

In order to make the best use of the available polyphony, set unused rhythm tones to “OFF.”

Wave Select

This is the setting page for “Selecting the Basic Waveform (Wave Select)” (p. 63).

Wave Gain

This parameter boosts the waveform. Raising the value by 6 dB will double the gain.

Range: -6, 0, +6, +12

Env Mode (Envelope Mode)

Specifies how the sound will play when a sustained-type waveform such as a whistle (a looped waveform) is selected.

Available settings:

SUSTAIN: The sound will continue as long as the keyboard pad is pressed.

NO-SUS: The sound will decay naturally even if you continue holding the keyboard pad.

* If a waveform with a long decay (one-shot waveform) is selected, setting this parameter to SUSTAIN will have no effect.

Mute Group

The Mute Group function lets you prevent percussion instruments in the same mute group from sounding simultaneously.

Range: OFF, 1–31

If you are not using the mute group function, set this OFF.

For example, on an acoustic drum set, it is physically impossible for the open hi-hat sound to be heard at the same time as the closed hi-hat sound. To simulate this, you can specify the same mute group number for both hi-hat sounds.

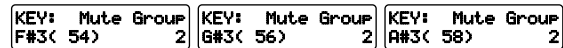

Changing the Pitch of the Sound (Pitch)

The PITCH section contains parameters that affect the pitch.

Approximate Pitch Adjustments (Coarse Tune)

For each rhythm tone, you can adjust the pitch in semitone steps.

1. Make sure that the [FUNC] indicator is dark.
2. Rotate the [COARSE TUNE] knob to adjust the Coarse Tune value.

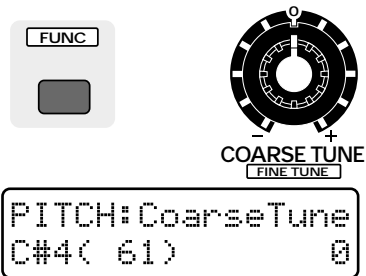

Range: -60–+60

As the knob is rotated further clockwise, the pitch will rise. As it is rotated counterclockwise, the pitch will fall.

Fine Pitch Adjustments (Fine Tune)

For each rhythm tone, you can make fine adjustments to the pitch in 1-cent steps (1/100th of a semitone).

1. Press [FUNC] to make the indicator blink.
2. Rotate the [FINE TUNE] knob to adjust the Fine Tune value.

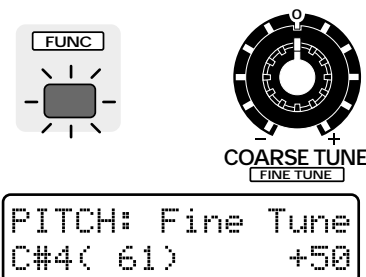

Range: -50–+50

As the knob is rotated further clockwise, the pitch will rise. As it is rotated counterclockwise, the pitch will fall.

Making More Detailed Settings

1. Hold down [EDIT] and press keyboard pad [2]. The display will show the PITCH section setting page.
2. Use PAGE [<] [>] to select parameters within the section, and edit them.

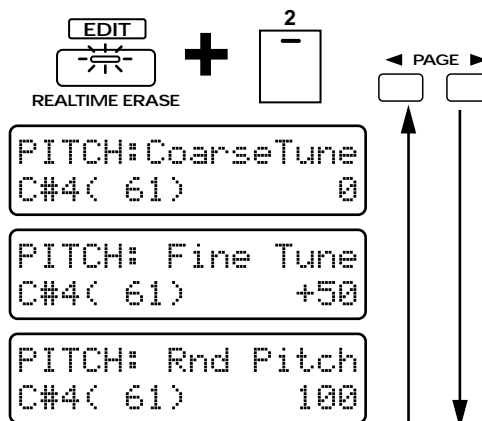

Coarse Tune

This is the setting page for “Approximate Pitch Adjustments (Coarse Tune)” (p. 64).

Fine Tune

This is the setting page for “Fine Pitch Adjustments (Fine Tune).”

Rnd Pitch (Random Pitch Depth)

This applies a degree of randomness to the pitch of each note.

Range: 0–1200

As this value is increased, a greater degree of randomness will be applied. As this value is decreased, there will be less randomness. With a value of “0” there will be no effect.

Making the Pitch Change Over Time (Pitch Envelope)

In the P-ENV (Pitch Envelope) section you can make settings to specify how the pitch of the percussion instrument will change over time.

Pitch Envelope Settings

1. Press [ENV SELECT] several times to select PITCH.
2. Use the [A]/[D]/[S]/[R] sliders to adjust the pitch envelope values.

Available settings:

[A]/[D]/[R]: 0–127

[S]: -63–+63

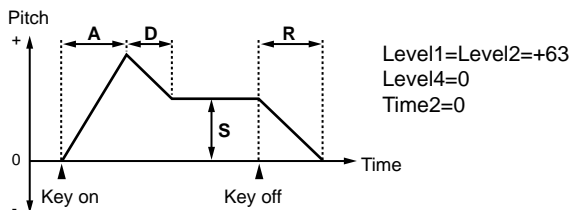
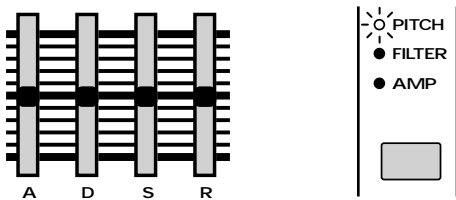

```
P-ENV: [A]Time1
C#4( 61) 0

P-ENV: [D]Time3
C#4( 61) 0

P-ENV: [S]Level3
C#4( 61) +63

P-ENV: [R]Time4
C#4( 61) 0
```

[A] (Attack Time)

The time from when the keyboard pad is pressed until the maximum pitch change is reached. Higher settings will cause the pitch to change over a longer time.

[D] (Decay Time)

The time from when the maximum pitch change is reached until the Sustain Level is reached.

Higher settings will cause the pitch to change over a longer time.

[S] (Sustain Level)

The pitch that will be held.

Positive (+) settings will make the pitch higher than the normal pitch. Negative (-) settings will make the pitch lower than the normal pitch.

[R] (Release Time)

The time from when the keyboard pad is released until the pitch returns to the normal pitch.

Higher settings will cause the pitch to change over a longer time.

Specifying the Envelope Depth (Pitch Envelope Depth)

Here's how you can adjust the depth of the Pitch Envelope.

1. Press [ENV SELECT] several times to select PITCH.

2. Use the [DEPTH] slider to adjust the Pitch Envelope Depth.

Range: -12–+12

Increasingly positive (+) settings will produce a greater width of pitch change. Negative (-) settings will invert the shape of the envelope, causing the pitch to change in the opposite direction.

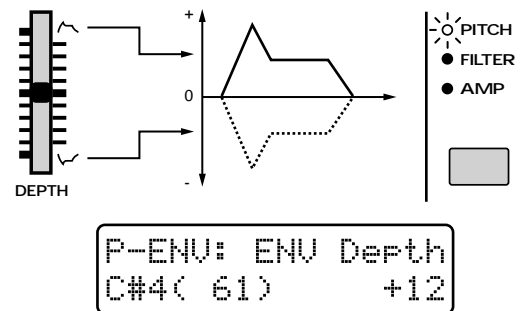

Making More Detailed Settings

1. Hold down [EDIT] and press keyboard pad [3].

The display will show the P-ENV section setting page.

2. Use PAGE [<] [>] to select parameters within the section, and edit them.

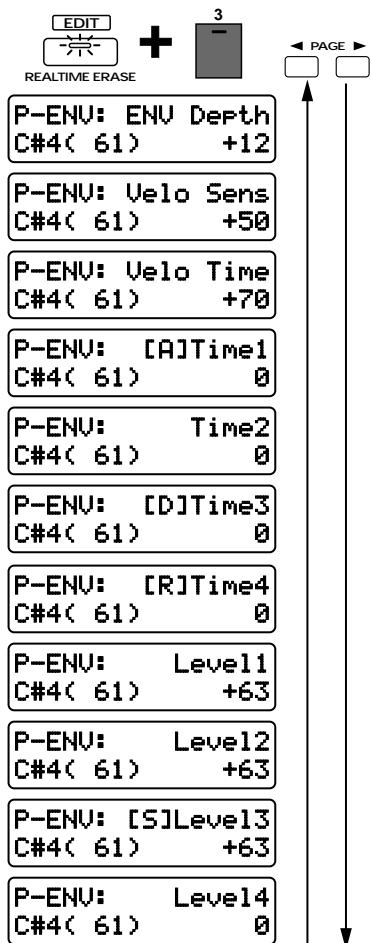

ENV Depth (Pitch Envelope Depth)

This is the setting page for “Specifying the Envelope Depth (Pitch Envelope Depth)” (p. 66).

Velo Sens (Pitch Envelope Velocity Sensitivity)

This setting lets you control the Pitch Envelope depth by the force with which you play the external MIDI keyboard.

Range: -100+150

With positive (+) settings, the pitch will change more greatly as you play the keyboard more strongly. With negative (-) settings, the pitch will change less as you play the keyboard more strongly.

* It is not possible to control this by varying the force with which you press the keyboard pads.

Velo Time (Pitch Envelope Velocity Time Sensitivity)

This parameter lets your playing dynamics on the external MIDI keyboard control the overall time of the entire Pitch Envelope.

Range: -100+100

With positive (+) settings, the Pitch Envelope times will become faster as you play the keyboard more strongly. With negative (-) settings, the Pitch Envelope times will become slower as you play the keyboard more strongly.

* It is not possible to control this by varying the force with which you press the keyboard pads.

The four front panel sliders [A]/[D]/[S]/[R] can be used to set the most commonly-used parameters of the pitch envelope, but the MC-505 also allows you to make more detailed pitch envelope settings.

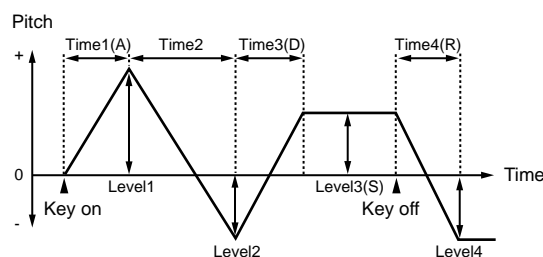

Time1D4 (Pitch Envelope Time 1D4)

Specifies the time until the next pitch level is reached. You can set the four parameters Time1-4.

Range: 0-127

Higher settings will result in a longer time until the next pitch level is reached.

* The front panel parameter [A] (Attack Time) corresponds to Time1, [D] (Decay Time) to Time3, and [R] (Release Time) to Time4.

Level1D4 (Pitch Envelope Level 1D4)

Specifies the pitch difference relative to the normal pitch (as specified by Coarse Tune and Fine Tune). You can set the four parameters Level1-4.

Range: -63+63

Positive (+) settings will raise the pitch above the normal pitch. Negative (-) settings will lower the pitch below the normal pitch.

* The front panel parameter [S] (Sustain Level) corresponds to Level3.

Modifying the Brightness of the Sound (Filter)

The FILTER section lets you make settings that affect the brightness of the percussion instrument sounds.

Selecting the Type of Filter (Filter Type)

Select the type of filter.

1. Make sure that the [FUNC] indicator is dark.
2. Press [FILTER TYPE] several times to select the type.

- LPF
- BPF
- HPF
- PKG

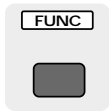

[RND PAN]



OFF:

The filter will not be used (all four indicators are dark).

LPF (Low Pass Filter):

This is the most common type of filter, and allows frequencies below the cutoff frequency to pass. It is used to make the sound more mellow.

HPF (High Pass Filter):

This filter allows frequencies above the cutoff frequency to pass. It is appropriate for creating percussion instrument sounds with a distinctive high frequency range.

BPF (Band Pass Filter):

This filter allows frequencies in the region of the cutoff frequency to pass, and cuts the rest. It is useful for creating sounds with a distinctive tone.

PKG (Peaking Filter):

This filter boosts the overtones in the region of the cutoff frequency. It allows you to simulate the resonance of a drum.

Brightening the Sound (Cutoff Frequency)

Specifies the frequency at which the filter will begin to affect the frequency components of the waveform (the Cutoff Frequency). By changing the cutoff frequency, you can control the brightness of the sound.

1. Make sure that the [FUNC] indicator is dark.

2. Rotate the [CUTOFF] knob to adjust the cutoff frequency value.

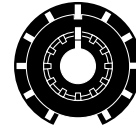
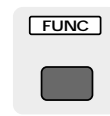

CUTOFF
TONE LEVEL



Range: 0–127

The effect will depend on the Filter Type.

LPF (Low Pass Filter)

Rotating the knob clockwise will cause the sound to become brighter, approaching the original waveform. Rotating it counterclockwise will cut more of the high frequency overtones, making the sound darker.

* For some waveforms, you may not be able to hear any sound if you lower the value too far.

HPF (High Pass Filter)

When the knob is turned clockwise, the low frequency range will be cut more greatly, making the sound sharper. As the knob is rotated counterclockwise, the original sound of the waveform will be heard.

* For some waveforms, you may hear no sound if this value is raised excessively.

BPF (Band Pass Filter)

Rotating the knob clockwise will raise the frequency area that is heard. Rotating the knob counterclockwise will cause only a progressively lower frequency area to be heard.

PKG (Peaking Filter)

When the knob is turned clockwise, the frequency area that is emphasized will rise. Rotating the knob counterclockwise will lower the frequency area that is emphasized.

Adding a Distinctive Character to the Sound (Resonance)

This setting emphasizes the overtones in the region of the cutoff frequency, adding character to the sound.

1. Make sure that the [FUNC] indicator is dark.
2. Rotate the [RESONANCE] knob to adjust the resonance setting.

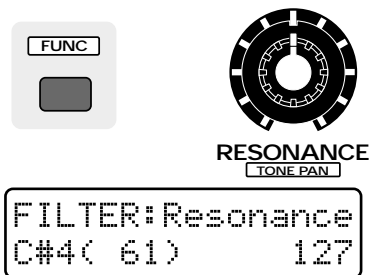

Range: 0–127

As the knob is rotated further clockwise, the sound will have more character. Rotating it counterclockwise will make the sound more natural.

Depending on the cutoff frequency setting, raising the resonance excessively may cause the sound to distort suddenly. In particular when Low Boost is being applied, the sound will be more prone to distort, so rotate [LOW BOOST] counterclockwise to adjust the boost amount until the sound no longer distorts.

“Using Low Boost to Adjust the Low Range” (Quick Start, p. 9)

In order to prevent the resonance from being increased excessively, factory settings have been made so that the value will not rise beyond “110” even if the [RESONANCE] knob is rotated all the way to the right. This is called the Resonance Limiter. You are free to adjust this upper limit.

“Specifying the Variable Range of Resonance (Resonance Limiter)” (p. 164)

If you have increased the Resonance Limiter setting, be careful not to raise the resonance excessively.

Making More Detailed Settings

1. Hold down [EDIT] and press keyboard pad [4].

The display will show the FILTER section setting page.

2. Use PAGE [<] [>] to select parameters within the section, and edit them.

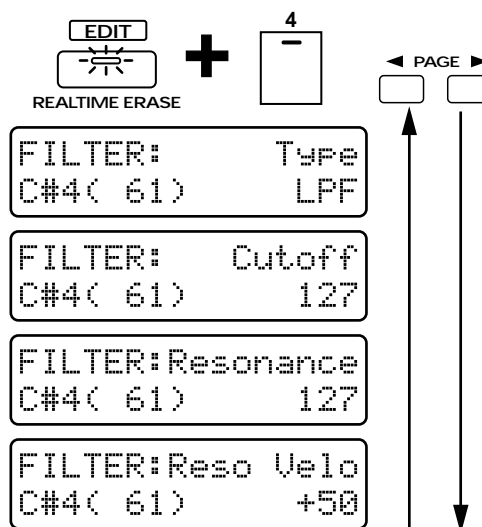

3

Type (Filter Type)

This is the setting page for “Selecting the Type of Filter (Filter Type)” (p. 68).

Cutoff (Cutoff Frequency)

This is the setting page for “Brightening the Sound (Cutoff Frequency)” (p. 68).

Resonance

This is the setting page for “Adding a Distinctive Character to the Sound (Resonance)” (p. 68).

Reso Velo (Resonance Velocity Sensitivity)

Specifies how resonance depth will be affected by your playing dynamics on the external MIDI keyboard.

Range: -100–+150

With positive (+) settings, playing the keyboard more strongly will cause the change to be greater. With negative (-) settings, playing the keyboard more strongly will cause the change to be less.

** It is not possible to control this by varying the force with which you press the keyboard pads.*

Making the Brightness Change Over Time (Filter Envelope)

On acoustic instruments, the tone quality (brightness) often changes over the duration of a note. For example, on a piano, the sound at the beginning of each note contains many overtones (i.e., has a bright tone), and as the note decays to silence, the overtones diminish, making the sound more mellow. The F-ENV (Filter Envelope) section lets you create this type of tonal change over time.

3

Filter Envelope Settings

1. [ENV SELECT] several times to select FILTER.
2. Use the [A]/[D]/[S]/[R] sliders to adjust the filter envelope values.

Range: 0–127

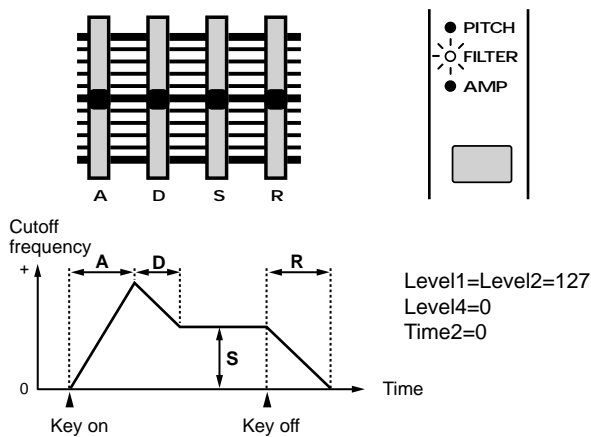

```
F-ENV: [A]Time1
C#4( 61) 10
```

```
F-ENV: [D]Time3
C#4( 61) 30
```

```
F-ENV: [S]Level3
C#4( 61) 80
```

```
F-ENV: [R]Time4
C#4( 61) 30
```

[A] (Attack Time)

The time from when the keyboard pad is pressed until the maximum tonal change is reached. Higher settings will cause the tonal change to occur over a longer time.

[D] (Decay Time)

The time from when the maximum tonal change is reached until the Sustain Level is reached. Higher settings will cause the tonal change to occur over a longer time.

[S] (Sustain Level)

The cutoff frequency level at which the tonal change will stabilize. Raising this setting will also raise the cutoff frequency.

[R] (Release Time)

The time from when the keyboard pad is released until the sound disappears. Higher settings will cause the tonal change to occur over a longer time.

Specifying the Depth of the Envelope (Filter Envelope Depth)

This setting adjusts the depth of the filter envelope.

1. Press [ENV SELECT] several times to select FILTER.
2. Use the [DEPTH] slider to adjust the Filter Envelope Depth setting.

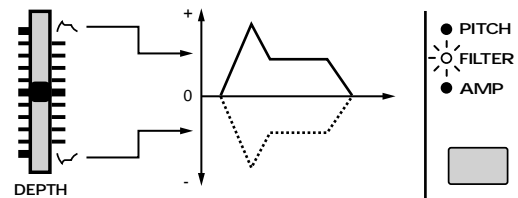

```
F-ENV: ENV Depth
C#4( 61) +63
```

Range: -63→+63

As the value is increased in the positive (+) direction, the amount of tonal change will increase. With negative (-) settings, the shape of the envelope will be inverted, and the tone will change in the opposite direction.

Making More Detailed Settings

1. Hold down [EDIT] and press keyboard pad [5].
The display will show the F-ENV section setting page.
2. Use PAGE [<] [>] to select parameters within the section, and edit them.

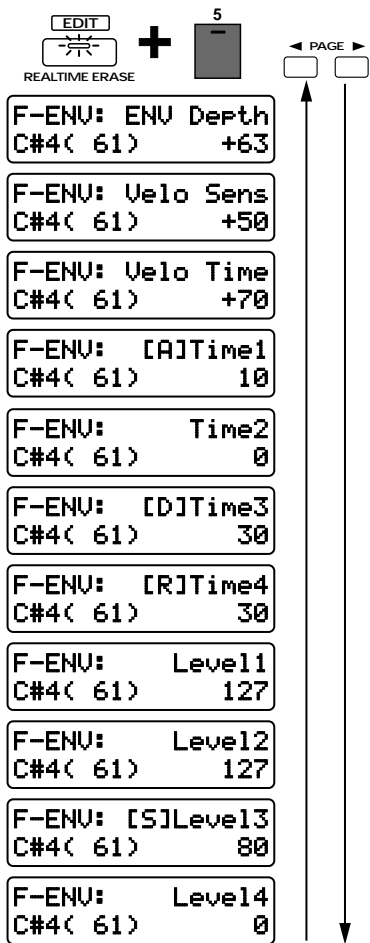

ENV Depth (Filter Envelope Depth)

This is the setting page for “Specifying the Depth of the Envelope (Filter Envelope Depth)” (p. 70).

Velo Sens (Filter Envelope Velocity Sensitivity)

Specifies how the force of your playing on the external MIDI keyboard will affect the filter envelope.

Range: -100–+150

With positive (+) settings, the tone will change more as you play more strongly on the keyboard. With negative (-) settings, the tone will change less as you play more strongly on the keyboard.

* It is not possible to control this by varying the force with which you press the keyboard pads.

Velo Time (Filter Envelope Velocity Time Sensitivity)

Specifies how the dynamics of your playing on the external MIDI keyboard will affect the overall time of the entire filter envelope.

Range: -100–+100

With positive (+) settings, the filter envelope times will become faster as you play the keyboard more strongly. With negative (-) settings, the filter envelope times will become slower as you play the keyboard more strongly.

* It is not possible to control this by varying the force with which you press the keyboard pads.

The four front panel sliders [A]/[D]/[S]/[R] can be used to set the most commonly-used parameters of the filter envelope, but the MC-505 also allows you to make more detailed filter envelope settings.

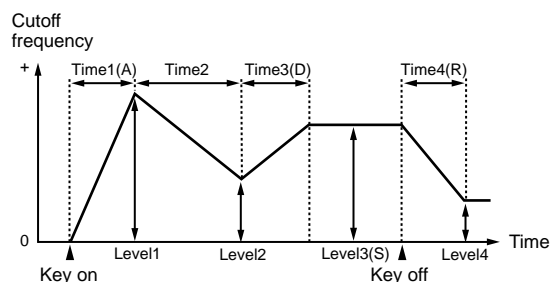

Time1D4 (Filter Envelope Time 1D4)

Specifies the time until the next cutoff frequency is reached. You can set the four values Time1–4.

Range: 0–127

Higher settings will lengthen the time until the next cutoff frequency is reached.

* The front panel [A] (Attack Time) corresponds to Time 1, [D] (Decay Time) to Time3, and [R] (Release Time) to Time4.

Level1D4 (Filter Envelope Level 1D4)

Specifies the cutoff frequency at each level. You can set the four values Level 1–4.

Range: 0–127

Higher settings will also raise the cutoff frequency.

* The front panel [S] (Sustain Level) corresponds to Level3.

Adjusting the Volume and Pan (Amplifier)

The AMP (amplifier) section contains settings related to the volume and stereo location of the sound.

Adjusting the Volume of Each Rhythm Tone (Rhythm Tone Level)

This setting adjusts the volume of each rhythm tone. This is used mainly to adjust the volume balance between rhythm tones.

- 3** 1. Press [FUNC] to make the indicator blink.
2. Rotate the [TONE LEVEL] knob to adjust the Rhythm Tone Level setting.

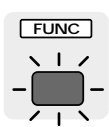

```
LEVEL: Tone Level
C#4( 61)    127
```

Range: 0–127

As the knob is rotated further clockwise, the volume will increase. As it is rotated counterclockwise, the volume will decrease.

* The overall volume of the entire rhythm set can be modified and memorized for each pattern as the Setup parameter Part Level. The Rhythm Tone Level setting will be multiplied by this value.

“Adjusting the Volume of Each Part (Part Level)” (p. 24)

Adjusting the Pan for Each Rhythm Tone (Rhythm Tone Pan)

This parameter sets the stereo location for each rhythm tone.

1. Press [FUNC] to make the indicator blink.
2. Rotate the [TONE PAN] knob to set the Rhythm Tone Pan value.

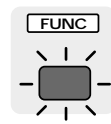

```
PAN:    Tone Pan
C#4( 61) 63R
```

Range: L64–63R

As the knob is rotated further clockwise, the stereo location will shift toward the right. As it is rotated counterclockwise, the location will shift toward the left.

* The pan of the overall rhythm set can be modified and set for each pattern by the Setup parameter Part Pan. The Rhythm Tone Pan value will be added to this setting.

“Adjusting the Pan of Each Part (Part Pan)” (p. 24)

Causing Pan to Change Randomly (Random Pan Switch)

This setting causes the stereo location to change randomly each time a note is played.

1. Press [FUNC] to make the indicator blink.
2. Press [RND PAN].

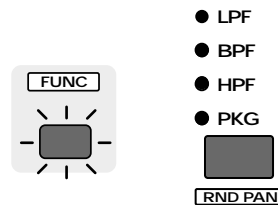

```
PAN:    Rnd Pan Sw
C#4( 61) OFF
```

All four indicators will be blinking, and the Random Pan Switch will be turned on.

* The Rhythm Tone Pan setting will be ignored by rhythm tones for which the Random Pan Switch is turned on.

Making More Detailed Settings

Volume-related settings

1. Hold down [EDIT] and press keyboard pad [6].

The display will show the AMPLIFIER/LEVEL section setting page.

2. Use PAGE [<] [>] to select parameters within the section, and edit them.

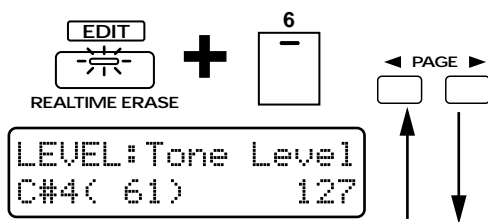

Tone Level (Rhythm Tone Level)

This is the setting page for “Adjusting the Volume of Each Rhythm Tone (Rhythm Tone Level)” (p. 72).

Pan-related settings

1. Hold down [EDIT] and press keyboard pad [7].

The display will show the AMPLIFIER/PAN section setting page.

2. Use PAGE [<] [>] to select parameters within the section, and edit them.

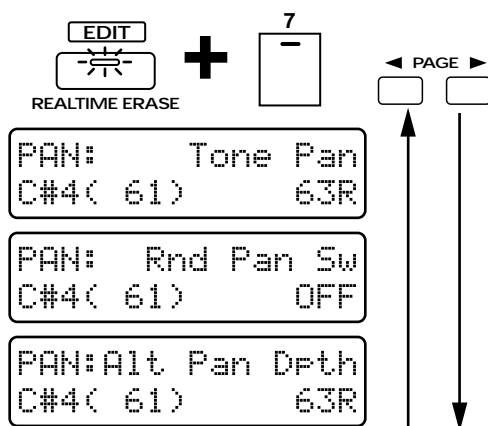

Tone Pan (Rhythm Tone Pan)

This is the setting page for “Adjusting the Pan for Each Rhythm Tone (Rhythm Tone Pan)” (p. 72).

Rnd Pan Sw (Random Pan Switch)

This is the setting page for “Causing Pan to Change Randomly (Random Pan Switch)” (p. 72).

Alt Pan Dpth (Alternate Pan Depth)

This parameter causes the stereo location of the sound to alternate between left and right each time a note is played.

Range: L63–63R

Higher settings will cause greater change.

When this parameter is set in the L direction, the sound will alternate in the order of left -> right-> left-> right. When set in the R direction, the sound will alternate in the order of right -> left-> right-> left.

If you don't know which rhythm tone you want to edit

Sometimes while playing back a pattern, you may wish to edit the snare drum that is being played by that pattern, but don't know which snare drum of the rhythm set is being played.

In such cases, select the rhythm part as the current part and press [MEASURE]. While you continue holding the button, the keyboard pad indicator for that rhythm tone will light at the timing at which the rhythm tone sounds. Use OCTAVE[-] [+] to change the key range, and find the keyboard pad that lights at the timing of the snare drum. This is the rhythm tone that you want to edit.

Creating Time-Varying Change in Volume (Amplifier Envelope)

On acoustic instruments, change in volume occurs over the duration of each note. For example, on a piano, the volume reaches the maximum level immediately, and then gradually decays to silence (decay-type instruments). On instruments such as an organ, the volume remains constant as long as the note is held (sustain-type instruments). The parameters of the A-ENV (amplifier envelope) section let you specify this type of time-varying change in volume (the Amplifier Envelope).

3

Amplifier Envelope Settings

1. [ENV SELECT] several times to select AMP.
2. Use the [A]/[D]/[S]/[R] sliders to adjust the amplifier envelope values.

Range: 0-127

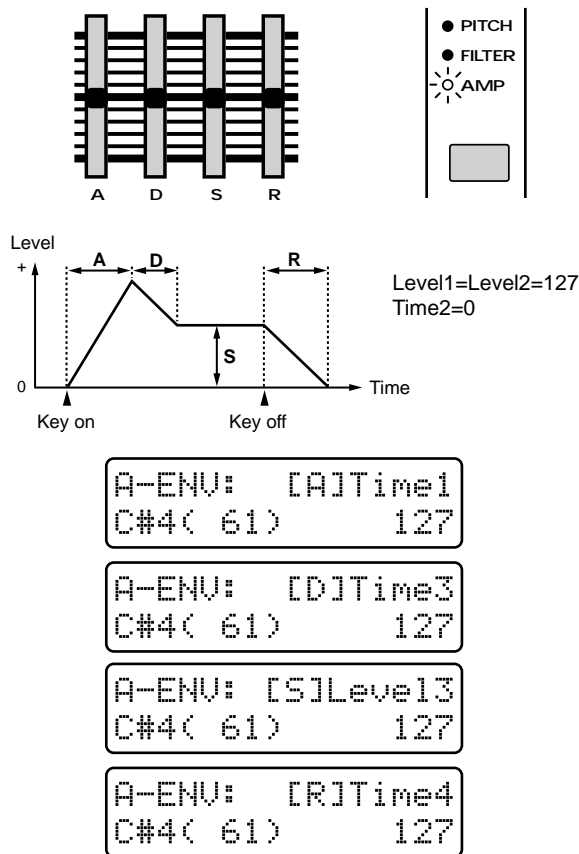

[A] (Attack Time)

The time from when the keyboard pad is pressed until the maximum volume is reached. Higher settings will cause the volume to change over a longer time.

[D] (Decay Time)

The time from when the maximum volume is reached until the Sustain Level is reached. Higher settings will cause the volume to change over a longer time.

[S] (Sustain Level)

The level at which the volume reaches a steady state. Higher settings will also raise the volume.

[R] (Release Time)

The time from when the keyboard pad is released until the volume decays to silence. Higher settings will cause the volume to change over a longer time.

Making More Detailed Settings

1. Hold down [EDIT] and press keyboard pad [8]. The display will show the A-ENV section setting page.
2. Use PAGE [<] [>] to select parameters within the section, and edit them.

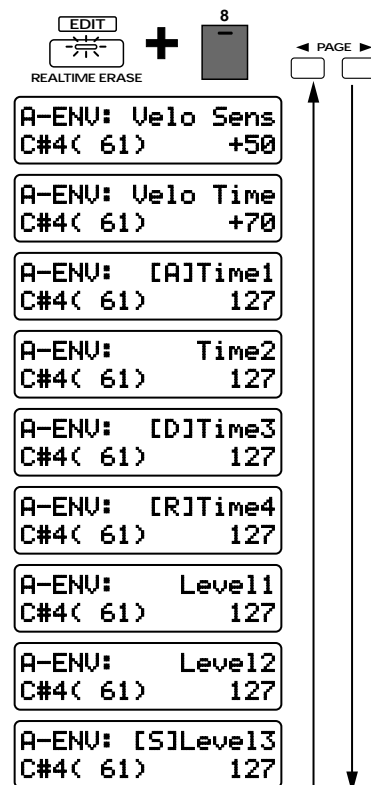

Velo Sens (Amplifier Envelope Velocity Sensitivity)

Specifies how the depth of the amplifier envelope will be affected by the strength of your playing on the external MIDI keyboard.

Range: -100—+150

With positive (+) settings, the volume will increase as you play more strongly on the keyboard. With negative (-) settings, the volume will decrease as you play more strongly on the keyboard.

If this is set to "0," the volume will not be affected by the strength of your playing on the keyboard pads.

* *It is not possible to control this by varying the force with which you press the keyboard pads.*

Velo Time (Amplifier Envelope Velocity Time Sensitivity)

Specifies how the overall times of the entire amplifier envelope will be affected by the strength of your playing on the external MIDI keyboard.

Range: -100—+100

With positive (+) settings, amplifier envelope times will become faster as you play the keyboard more strongly. With negative (-) settings, amplifier envelope times will become slower as you play the keyboard more strongly.

* *It is not possible to control this by varying the force with which you press the keyboard pads.*

The four front panel sliders [A]/[D]/[S]/[R] can be used to set the most commonly used parameters of the amplifier envelope, but the MC-505 also allows you to make more detailed amplifier envelope settings.

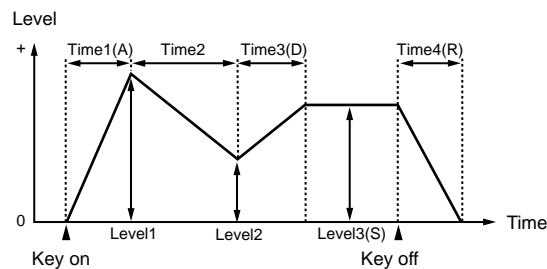

Time1D4 (Amplifier Envelope Time 1D4)

Specifies the time until the next level point is reached. This can be set for each of the four parameters Time 1–4.

Range: 0–127

Higher settings will lengthen the time until the next level point is reached.

* *The front panel parameter [A] (Attack Time) corresponds to Time1, [D] (Decay Time) to Time3, and [R] (Release*

Time) to Time4.

Level1D3 (Amplifier Envelope Level 1D3)

These parameters specify the volume at each point. You can set the three points Level1–3.

Range: 0–127

Higher settings will also raise the volume.

* The front panel [S] (Sustain Level) corresponds to Level 3.

Adjusting the Range of Pitch Bend (Bend Range)

3 Specifies the amount of pitch change (in semitone units) that will occur when the pitch bend lever of an external MIDI device is operated.

1. Hold down [EDIT] and press keyboard pad [14].

The display will show the CONTROL/PITCH BEND section setting page.

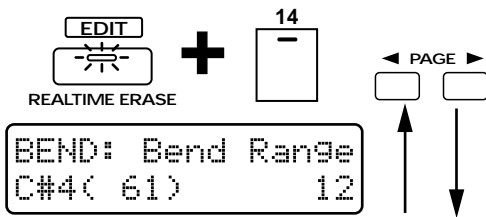

Range: 0–12 semitones

Higher settings will result in a greater pitch change when the pitch bend lever is moved to the left or right. For example, if this parameter is set to “12,” the pitch will rise one octave when the pitch bend lever is moved to the right-most position.

Adjusting the Effects/Specifying the Output Destination for Each Rhythm Tone

In the RHY TONE (Rhythm Tone) section you can adjust the amount of effects that will be applied to each rhythm tone, and specify the output destination of each rhythm tone.

1. Hold down [EDIT] and press keyboard pad [16].

The display will show the RHY TONE section setting page.

2. Use PAGE [<] [>] to select parameters within the section, and edit them.

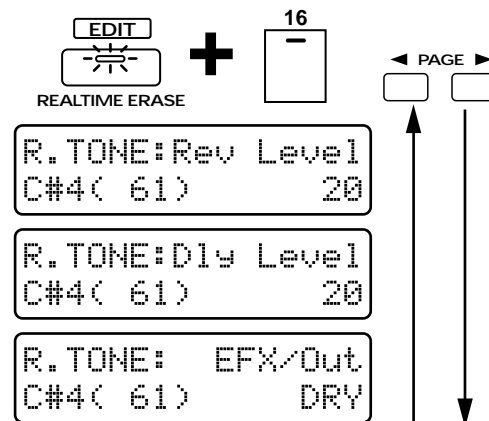

R.TONE Rev Level (Rhythm Tone Reverb Level)

Specifies the reverb volume for each rhythm tone.

Range: 0–127

Higher settings will increase the reverb volume.

* The Rhythm Tone Reverb Level setting is valid only if the Part EFX/Output Assign setting of the rhythm part is set to “RHY.” Also in this case, if the Reverb Level and the Part Reverb Level setting of the rhythm part are low, there will be no reverb even if the Rhythm Tone Reverb Level is raised.

📖 “Applying EFX/Specifying the Output Destination for Each Part (Part EFX/Output Assign)” (p. 104)

🔗 Adjusting the Overall Reverb Volume (Reverb Level) (p. 80)

🔗 Adjusting the Reverb Volume for Each Part (Part Reverb Level) (p. 80)

• If you would like to know more about reverb settings...

🔗 “Adding Reverberation to the Sound

(Reverb)" (p. 79)



R.TONE Dly Level (Rhythm Tone Delay Level)

Specifies the amount of delay for each rhythm tone.

Range: 0–127

Higher settings will increase the delay volume.

* *The Rhythm Tone Delay Level setting is valid only when the Part EFX/Output Assign setting of the rhythm part is set to "RHY." Also in this case, if the Delay Level and the Part Delay Level setting of the rhythm part are low, there will be no delay even if the Rhythm Tone Delay Level is raised.*

  **"Applying EFX/Specifying the Output Destination for Each Part (Part EFX/Output Assign)" (p. 104)**

 **Adjusting the Overall Delay Volume (Delay Level) (p. 84)**

 **Adjusting the Delay Volume for Each Part (Part Delay Level) (p. 84)**

•If you would like to know more about delay settings...

 **"Adding an Echo to the Sound (Delay)" (p. 82)**

R.TONE EFX/Out (Rhythm Tone EFX/Output Assign)

For each rhythm tone, you can turn EFX on/off and specify the output jacks from which the sound will be output. Make these settings when you wish to apply EFX only to specific rhythm tones, or to output only specific rhythm tones from the DIRECT 1/2 jacks.

Available settings:



DRY: Stereo output from the MIX jacks without applying EFX (EFX off).

EFX: Apply EFX, and output in stereo from the MIX jacks (EXF on).

DIR1: Stereo output from the DIRECT 1 jacks.

DIR2: Stereo output from the DIRECT 2 jacks.

* *Rhythm Tone EFX/Output Assign settings are valid only when the Part EFX/Output Assign setting of the rhythm part is "RHY."*

  **"Applying EFX/Specifying the Output Destination for Each Part (Part EFX/Output Assign)" (p. 104)**

* *Effects (reverb/delay/EFX) are not applied to the sound that is output from the DIRECT 1/2 jacks.*

Using the outputs as four mono outputs

By setting the Rhythm Tone Pan to full left or right, you can use the outputs as up to four mono outputs. Set the Part EFX/Output Assign of the rhythm part to "RHY."

R. TONE: EFX/Out C 4(60) DIR1	PAN: Tone Pan C 4(60) L64
R. TONE: EFX/Out C#4(61) DIR1	PAN: Tone Pan C#4(61) 63R
R. TONE: EFX/Out D 4(62) DIR2	PAN: Tone Pan D 4(62) L64
R. TONE: EFX/Out D#4(63) DIR2	PAN: Tone Pan D#4(63) 63R

R1234567 EFX/Out RDDEEDDE R= RHY

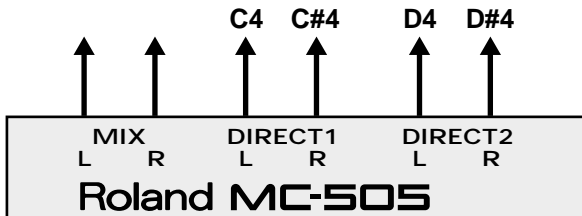

* If the EFX Output Level setting is low, the rhythm tone with EFX applied will not be heard (p. 86).

If you would like to know more about EFX settings...
 "Applying Various Effects to the Sound (EFX)" (p. 86)

Saving Rhythm Sets You've Created (Rhythm Set Write)

When you have created a rhythm set that you like, you can save it as a User Rhythm Set.

1. Make sure that the pattern is stopped.
2. Press [PATCH] to access the rhythm set select page.

When you modify the settings of a rhythm set, an asterisk "*" will appear at the left of the number, indicating that the selected rhythm set has been modified (edited). Be aware that if you select a different rhythm set without saving the modified rhythm set, your changes will be lost.

3. Press [WRITE].
The following display will appear, and the cursor "_" will appear under the number.



If you do not wish to change the number or name, you can omit steps 4–8.

If you decide not to save the rhythm set, press [EXIT].

4. Press [USER] or [CARD] to select the save destination bank.

* CARD banks can be selected only if an optional memory card is inserted.

"Using Memory Cards" (p. 159)

5. Use [INC] [DEC] or the [VALUE] dial to select the save destination number.

At this time, you can press [UNDO/REDO] to check the name of the rhythm set that is currently in the save destination number. After you have found a rhythm set that you do not mind overwriting, press [UNDO/REDO] once again to return to the previous display.

6. Press PAGE [>].

The cursor will move to the beginning of the second line in the display.

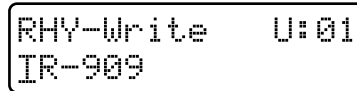

7. Assign a name to the rhythm set.

Use [INC] [DEC] or the [VALUE] dial to specify the character.

The following characters can be selected.

Space, A–Z, a–z, 0–9, ! " # \$ % & ' () * +, - . / : ; < = > ? @ [¥] ^ _ ` { | }

8. Repeat steps 6D7 to input the name.

By pressing PAGE [<] you can move the cursor back toward the left.

A name of up to 12 characters can be input.

9. Press [ENTER].

The confirmation screen will appear in the display.

If you decide to cancel the operation, press [EXIT].

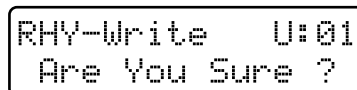

Chapter 4. Applying Effects to the Sound (Effects)

The MC-505 comes with three effects units: reverb, delay and EFX. Each of them can be set independently. The following diagram shows the signal flow for these effects.

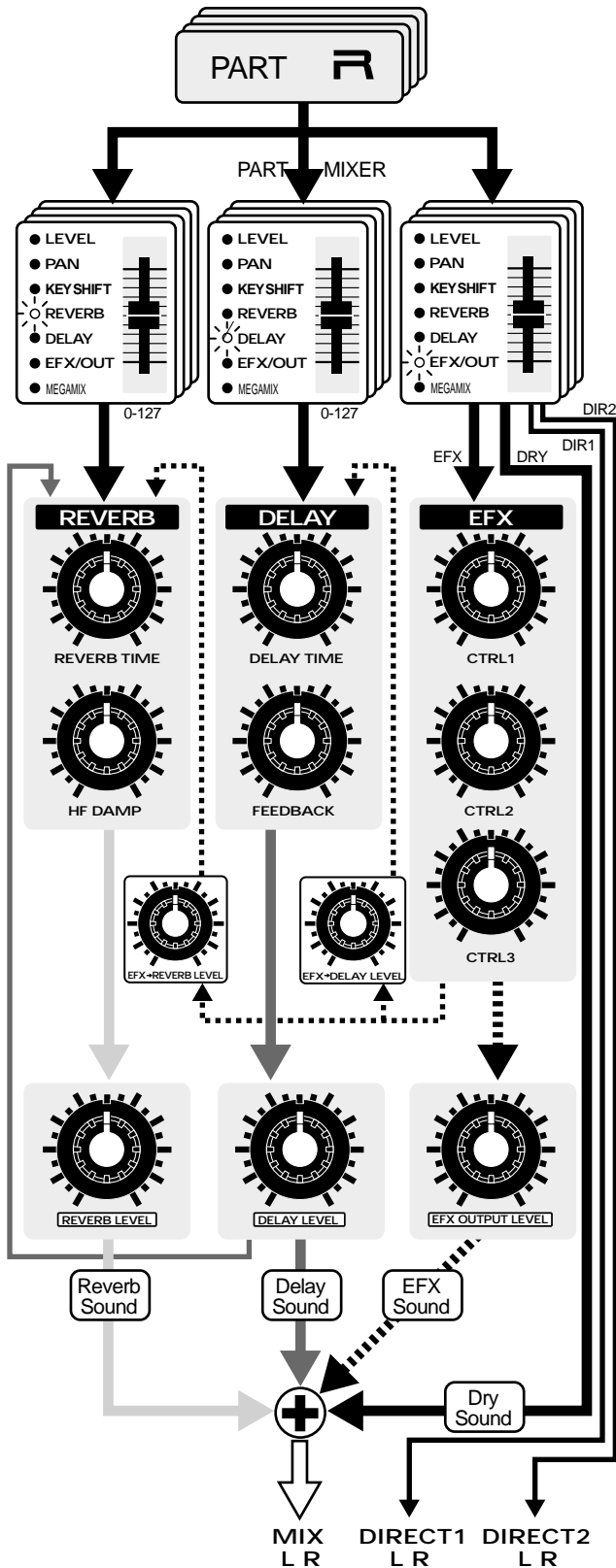

Since the effect settings you modify can be saved for each pattern, effect settings can be switched simply by selecting a pattern.

To save modified effects settings in a pattern...
 "Saving Patterns You've Modified (Pattern Write) (p. 26)"

* If you switch patterns while playback is stopped, all effect settings will be updated. However, if you switch patterns during playback, reverb and delay parameters other than Part Reverb Level and Part Delay Level will maintain the values of the previous pattern.

"Adjusting the Reverb Volume for Each Part (Part Reverb Level)" (p. 80)
 "Adjusting the Delay Volume for Each Part (Part Delay Level)" (p. 84)

4

Adding Reverberation to the Sound (Reverb)

Reverb is an effect which adds reverberation and ambiance to the sound, creating an impression of spatial depth. It simulates the sound of music played in a concert hall. In the REVERB section you can make settings which control the reverb.

Selecting the Type (Reverb Type)

One of the following six basic types of reverb can be selected.

1. Press [EFFECT SELECT].
While the button is pressed, the currently selected Reverb Type will be shown in the left of the display.
2. Hold down [EFFECT SELECT] and rotate the [REV LEVEL] knob to select the Reverb Type.

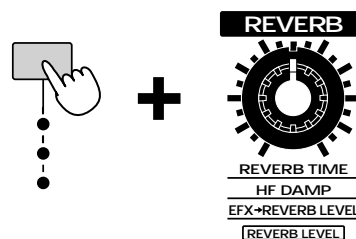
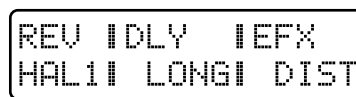

Available Settings:

- ROM1 (Room 1): Reverb with short decay and high-density.
- ROM2 (Room 2): Reverb with short decay and low density.
- STG1 (Stage 1): Reverb with much lingering reverberation.
- STG2 (Stage 2): Reverb with strong early reflections.
- HAL1 (Hall 1): Clear-sounding reverb.
- HAL2 (Hall 2): Rich-sounding reverb.

Reverb on/off

Hold down [EFFECT SELECT] and press [PRESET] to switch reverb on/off.

When reverb is off, the following display will appear.

4



This setting cannot be stored in a pattern.

Adjusting the Length of Reverberation (Reverb Time)

You can adjust the time over which the reverberation will continue.

1. Make sure that the [FUNC] indicator is dark. If it is blinking, press the button to make it go dark.
2. Press [EFFECT SELECT] several times to make the top indicator light.
3. Rotate the [REVERB TIME] knob to set the reverb time.

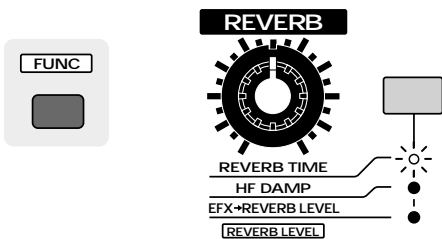

Range: 0–127

Rotating the knob clockwise will lengthen the reverb time. Rotating the knob counterclockwise will shorten the reverb time.

Adjusting the Tone of the Reverberation (HF Damp)

Specifies the frequency at which the high frequency portions of the reverberation will be cut.

1. Make sure that the [FUNC] indicator is dark. If it is blinking, press the button to make it go dark.
2. Press [EFFECT SELECT] several times to make the middle indicator light.
3. Rotate the [HF DAMP] knob to set HF Damp.

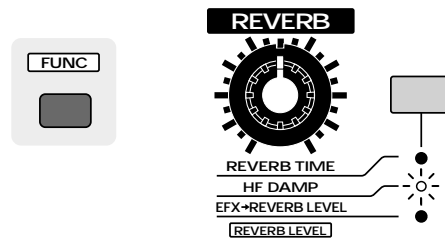

Range: 200–8000 (Hz), BYPASS

Lowering this setting will cause more of the upper frequency content to be cut, making the reverberation more muted in tone.

If you do not wish to cut the high frequency range, rotate the knob fully right to select “BYPASS.”

Adjusting the Overall Reverb Volume (Reverb Level)

You can adjust the overall volume of reverb for the eight parts (rhythm part and parts 1–7).

1. Press [FUNC] to make the indicator blink.
2. Rotate the [REV LEVEL] knob to adjust the Reverb Level.

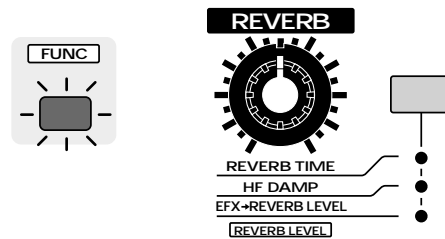

Range: 0–127

Rotating the knob clockwise will increase the reverb volume. Rotating the knob counterclockwise will decrease the reverb volume.

Adjusting the Reverb Volume for Each Part (Part Reverb Level)

You can adjust the reverb volume for each part.

1. Press [MIXER SELECT] several times to make the REVERB indicator light.
2. Move the part sliders [R]D[7] to adjust the Part Reverb Level of each part.

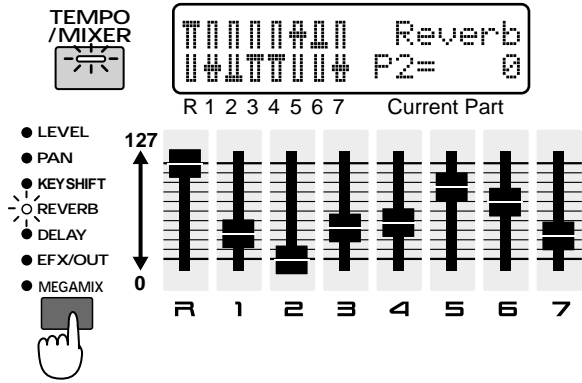

Range: 0–127

Raising the slider will increase the reverb volume. Lowering the slider will decrease the reverb volume. If you press [TEMPO/MIXER] to switch to the Part Mixer page, the Part Reverb Level of each part will be displayed graphically. At this time you can use [INC] [DEC] to modify the setting values of the current part.

If you wish to apply reverb to parts that are not using EFX, be aware that if either the Part Reverb Level of that part or the Reverb Level of all parts is set to “0,” no reverb will be applied to that part. Also, if you set the Part EFX/Output Assign setting of the rhythm part to “RHY,” you will be able to adjust the reverb volume for each rhythm tone.

📖 “Applying EFX/Specifying the Output Destination for Each Part (Part EFX/Output Assign)” (p. 104)

- If you wish to adjust the reverb volume for each rhythm tone...

👉 “R.TONE Rev Level (Rhythm Tone Reverb Level)” (p. 76)

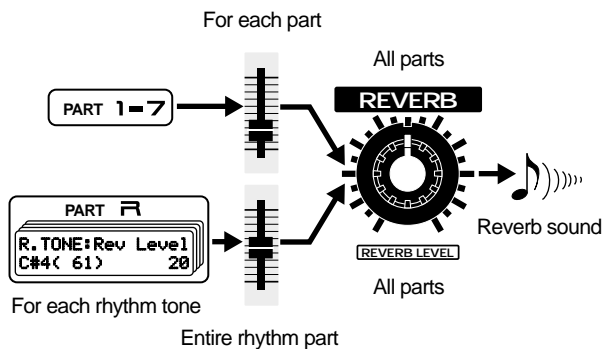

When the Part EFX/Output Assign setting of the rhythm part is “DRY” or “EFX,” raising the Part Reverb Level will apply reverb to all rhythm tones equally.

Applying Reverb to the EFX Sound (EFX-> Reverb Level)

Perform the following to set the volume of the reverb applied to the EFX sound.

Regardless of the Part Reverb Level of each part, reverb will apply equally to all parts whose Part EFX/Output Assign setting is “EFX.”

1. Make sure that the [FUNC] indicator is dark.
2. Press [EFFECT SELECT] several times to make the bottom indicator light.
3. Rotate the [EFX->REVERB LEVEL] knob to set EFX->Reverb Level.

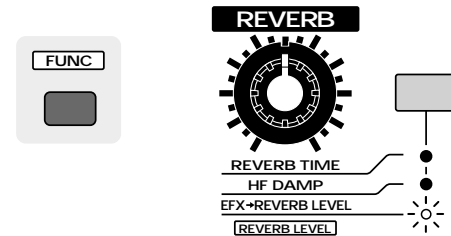

Range: 0–127

Rotating the knob clockwise will increase the volume of the reverb applied to the EFX sound. Rotating it counterclockwise will decrease the volume of the reverb applied to the EFX sound.

* This will not affect a part if its “Part EFX/Output Assign” setting is at something other than “EFX.”

📖 “Applying EFX/Specifying the Output Destination for Each Part (Part EFX/Output Assign)” (p. 104)

Making More Detailed Settings

In addition to setting them from the front panel, you can use the following procedure to adjust parameters (other than Part Reverb Level) while you view their current value.

1. Hold down [SHIFT] and press keyboard pad [5].
2. Use PAGE [<] [>] to select parameters within the section, and set the desired parameter value.



4

To exit the setting page, press [EXIT].

Type (Reverb Type)

As in “Selecting the Type (Reverb Type)” (p. 79), select the basic type of reverb.

Range: ROOM1, ROOM2, STAGE1, STAGE2, HALL1, HALL2

* In the setting page of p. 79, the type name will be displayed as an abbreviation.

Reverb Time

This is the setting page for “Adjusting the Length of Reverberation (Reverb Time)” (p. 80).

Range: 0–127

HF Damp

This is the setting page for “Adjusting the Tone of the Reverberation (HF Damp)” (p. 80).

Range: 200–8000 (Hz), BYPASS

EFX->Rev Lvl (EFX->Reverb Level)

This is the setting page for “Applying Reverb to the EFX Sound (EFX->Reverb Level)” (p. 81).

Range: 0–127

Reverb Level

This is the setting page for “Adjusting the Overall Reverb Volume (Reverb Level)” (p. 80).

Range: 0–127

Adding an Echo to the Sound (Delay)

Delay is an effect which adds echoes to the sound. It is effective when applied to solo phrases or to densely rhythmic phrases. In the DELAY section you can make settings that specify how the delay will sound.

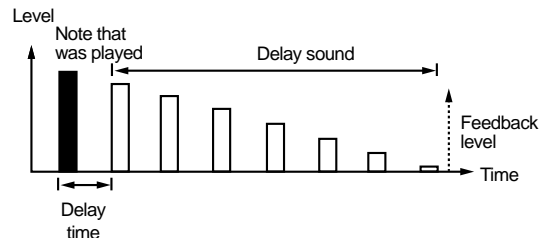

Selecting the Type (Delay Type)

One of the following two basic types of delay can be selected.

1. Press [EFFECT SELECT].

While the button is pressed, the currently selected delay type will be shown in the center of the display.

2. Hold down [EFFECT SELECT] and rotate the [DELAY LEVEL] knob to select the delay time.

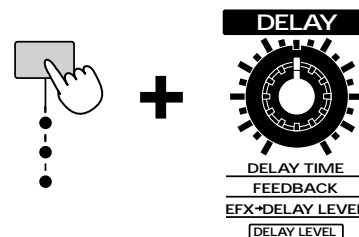
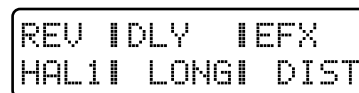

Available Settings:

SHORT: A delay which repeats at short intervals.

LONG: A delay which repeats at long intervals.

You can also synchronize the spacing of the repeats to the tempo of the pattern (p. 83).

Delay on/off

Hold down [EFFECT SELECT] and press [USER] to turn delay on/off.

When delay is off, the following display will appear.



This setting cannot be stored in a pattern.

Adjusting the Delay Interval (Delay Time)

Adjusts the time from the original sound until when the delayed sound is heard (the interval between repeats).

1. **Make sure that the [FUNC] indicator is dark.**
If it is blinking, press the button to make it go dark.
2. **Press [EFFECT SELECT] several times to make the top indicator light.**
3. **Rotate the [DELAY TIME] knob to set the delay time.**

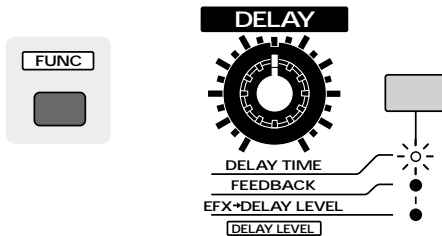

Available Settings:

SHORT: 0.1–275

LONG: 200–1000, ♪ ♪ ♪ ♪ ♪ ♪ ♪ ♪ ♪ ♪ ♪ ♪ ♪ ♪ ♪ ♪

Rotating the knob clockwise will lengthen the time until the delay sound is heard. Rotating the knob counterclockwise will shorten the time until the delay sound is heard.

When the delay type is set to “LONG,” you can hold down [SHIFT] and rotate the [DELAY TIME] knob to adjust the setting as a note value. The delay will synchronize to the tempo of the pattern, and will sound at intervals of the specified note value.

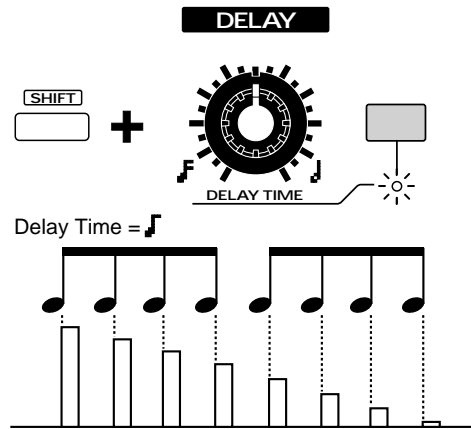

* On the MC-505, it is not possible to set a delay time longer than 1000 ms (1 second). When the delay time is synchronized to the tempo, selecting a note value which would make the delay time exceed 1000 ms will cause the delay time to be halved, and the delay sound will be heard at 1/2 the specified interval. In addition, even if 1/2 the length would exceed 1000 ms, the delay time will be shortened to 1/4 the length.

Adjusting the Number of Repeats (Feedback Level)

Adjusts the number of times that the delay sound will be repeated.

1. **Make sure that the [FUNC] indicator is dark.**
If it is blinking, press the button to make it go dark.
2. **Press [EFFECT SELECT] several times to make the middle indicator light.**
3. **Rotate the [FEEDBACK] knob to set the feedback level.**

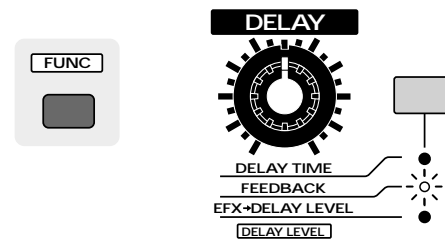

Range: 0–+98 (%)

Rotating the knob clockwise will increase the number of repeats. Rotating the knob counterclockwise will decrease the number of repeats.

Adjusting the Overall Delay Volume (Delay Level)

This adjusts the volume of the delay sound for all eight parts (the rhythm part and parts 1–7).

1. Press [FUNC] to make the indicator blink.
2. Rotate the [DELAY LEVEL] knob to adjust the delay level.

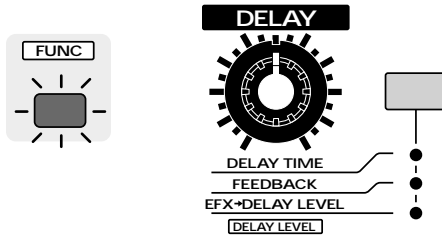

4

Range: 0–127

Rotating the knob clockwise will increase the volume of the delay sound. Rotating the knob counterclockwise will decrease the volume of the delay sound.

Adjusts the Delay Volume for Each Part (Part Delay Level)

Adjusts the volume of the delay sound for each part.

1. Press [MIXER SELECT] several times to make the DELAY indicator light.
2. Use part sliders [R]D[7] to set the Part Delay Level for each part.

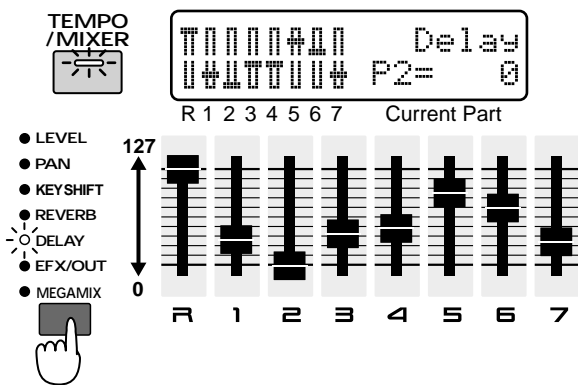

Range: 0–127

Raising the slider will increase the volume of the delay sound. Lowering it will decrease the volume of the delay sound.

If you press [TEMPO/MIXER] to access the Part Mixer page, the Part Delay Level of each part will be displayed graphically. At this time you can use [INC] [DEC] to modify the setting values of the current part.

If you wish to apply delay to parts that are not using EFX, be aware that if either the Part Delay Level of that part or the Delay Level of all parts is set to “0,” no delay will be applied to that part. Also, if you set the Part EFX/Output Assign setting of the rhythm part to “RHY,” you will be able to adjust the delay volume for each rhythm tone.

☞ “Applying EFX/Specifying the Output Destination for Each Part (Part EFX/Output Assign)” (p. 104)

• If you wish to adjust the delay volume for each rhythm tone...

☞ “R.TONE Dly Level (Rhythm Tone Delay Level)” (p. 76)

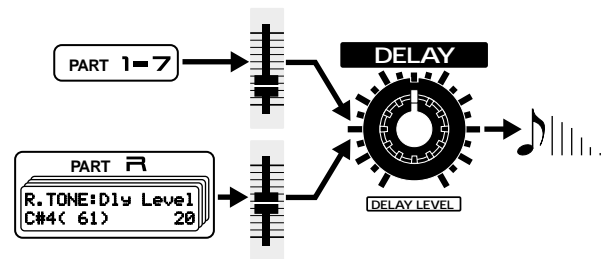

When the Part EFX/Output Assign setting of the rhythm part is “DRY” or “EFX,” raising the Part Delay Level will apply delay to all rhythm tones equally.

Applying Delay to the EFX Sound (EFX->Delay Level)

Specifies the volume of the delay that will be applied to the EFX sound.

Regardless of the Part Delay Level of each part, delay will apply equally to all parts whose Part EFX/Output Assign setting is “EFX.”

1. Make sure that the [FUNC] indicator is dark. If it is blinking, press the button to make it go dark.
2. Press [EFFECT SELECT] several times to make the bottom indicator light.
3. Rotate the [EFX->DELAY LEVEL] knob to set the EFX ->Delay Level.

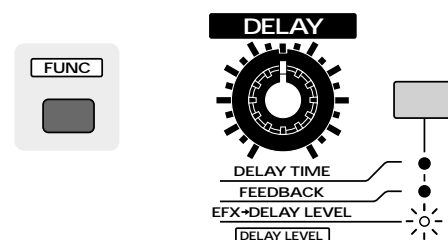

Range: 0–127

Rotating the knob clockwise will increase the volume of the delay that is applied to the EFX sound. Rotating it counterclockwise will decrease the volume of the delay that is applied to the EFX sound.

** This will not affect a part if its “Part EFX/Output Assign” setting is at something other than “EFX.”*

“Applying EFX/Specifying the Output Destination for Each Part (Part EFX/Output Assign)” (p. 104)

Making More Detailed Settings

In addition to setting them from the front panel, you can also use the following procedure to set parameters (other than Part Delay Level) while viewing the value.

1. Hold down [SHIFT] and press keyboard pad [6].

The setting page for the DELAY section will appear.

2. Use PAGE [<] [>] to select parameters within the section, and modify their values.

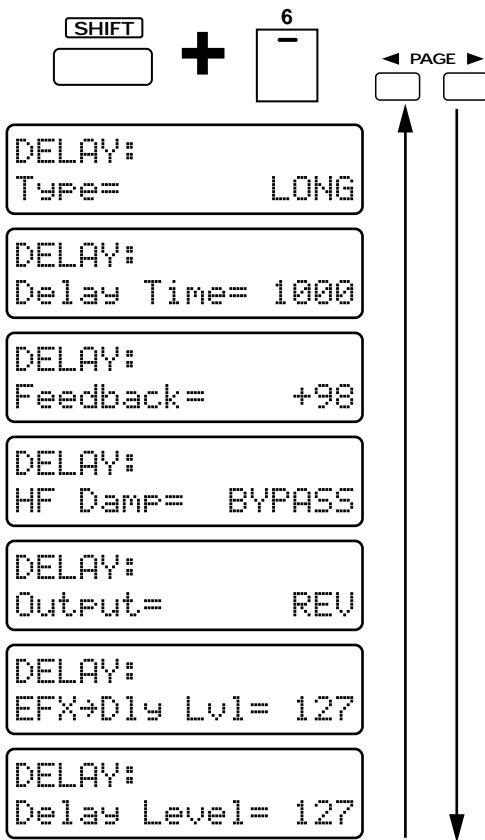

To exit the setting page, press [EXIT].

Type (Delay Type)

Select the delay type in the same way as explained in “Selecting the Type (Delay Type)” (p. 82).

Range: SHORT, LONG

Delay Time

This is the setting page for “Adjusting the Delay Interval (Delay Time)” (p. 83).

Available Settings:

SHORT: 0.1–275

LONG: 200–1000,

Feedback

This is the setting page for “Adjusting the Number of Repeats (Feedback Level)” (p. 83).

Range: 0–+98 (%)

HF Damp

Determines the frequency at which the high frequency portions of the delay sound will be cut.

Range: 200–8000 (Hz), BYPASS

As this parameter is set to a lower frequency, more of the high range will be cut, making the delay sound more muted in tone.

If you do not wish to cut the high frequency range, select “BYPASS.”

Output (Delay Output Assign)

Specifies how the delay sound will be output.

Available Settings:

MIX: The delay sound will be output as is.

REV: Reverb will be applied to the delay sound before it is output.

MIX+REV: Delay without reverb and delay with reverb will both be output.

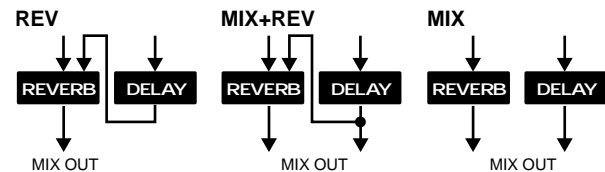

EFX->Dly Lvl (EFX->Delay Level)

This is the setting page for “Applying Delay to the EFX Sound (EFX->Delay Level)” (p. 84).

Range: 0–127

Delay Level

This is the setting page for “Adjusting the Overall Delay Volume (Delay Level)” (p. 84).

Range: 0–127

Applying Various Effects to the Sound (EFX)

General Purpose Multi-Effects

EFX provides 24 different Effect Types, each of which let you apply a different effect. In the EFX section you can make settings that determine how EFX will sound.

Selecting the Type (EFX Type)

One of the following 24 types of EFX can be selected.

1. Press [EFFECT SELECT].

While the button is pressed, the currently selected EFX Type will be shown in the right of the display.

2. Hold down [EFFECT SELECT] and rotate the [EFX OUTPUT LEVEL] knob to select the EFX Type.

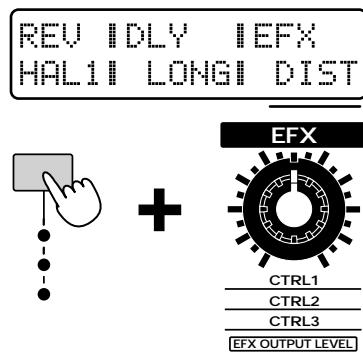

You can also do this by holding down [EFFECT SELECT] and rotating the [VALUE] dial.

Available Settings:

- 4-EQ:** 4 band EQ (modify the tone)
- SPCTM:** Spectrum (add character to the sound)
- ENHR:** Enhancer (add sparkle to the sound)
- OVER:** Overdrive (distort the sound mildly)
- DIST:** Distortion (distort the sound severely)
- Lo-Fi:** Lo-Fi (simulate a "low-fidelity" sound)
- NOISE:** Noise generator (add various types of noise)
- RADIO:** Radio tuning (simulate a radio being tuned)
- PHONO:** Phonograph (simulate an old record)
- COMP:** Compressor (make the volume level more consistent)
- LIMT:** Limiter (smooth out irregularities in volume)
- SLICE:** Slicer (apply successive cuts to the sound)
- TREMO:** Tremolo (cyclic changes in volume)
- PHASE:** Phaser (modulate the sound)

- CHORS:** Chorus (add spaciousness and depth to the sound)
- SP-D:** Space-D (add transparent depth)
- TETR:** Tetra chorus (layer chorus sounds to add spaciousness)
- FLANG:** Flanger (add metallic resonance to the sound)
- ST-FL:** Step flanger (add metallic resonance to the sound while changing the pitch in steps)
- S-DLY:** Short delay (add echoes to the sound)
- A-PAN:** Auto pan (automatically move the stereo location)
- FB-P:** Feedback pitch shifter (skew the pitch)
- REV:** Reverb (add reverberation)
- GATE:** Gated reverb (sharply cut the reverberation)

* In this screen page, the names of each type are displayed as an abbreviation.

The parameters of the effect will depend on the EFX Type that you selected. Of the parameters of each effect, the main ones can be adjusted using the front panel [EFX OUTPUT LEVEL] knob and the [CTRL 1/2/3] knob. For details on which knob corresponds to each parameter, refer to the explanatory diagram for each effect.

Each knob is operated in the same way as for Reverb or Delay.

For example, in the case of the 4-band EQ, operation will be as follows.

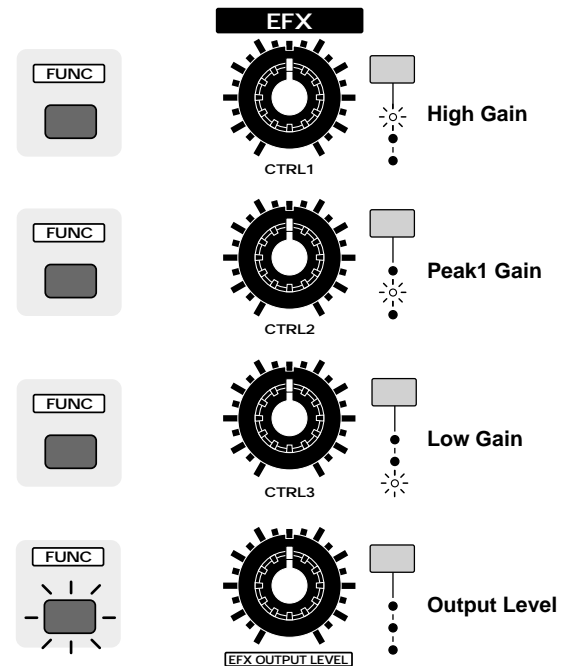

In addition to setting them from the front panel, you can also use the following procedure to set parameters (other than Part EFX/Output Assign) while viewing their value.

1. Hold down [SHIFT] and press keyboard pad [7].

The setting page for the EFX section will appear.

2. Use PAGE [<] [>] to select parameters within the section, and make settings.

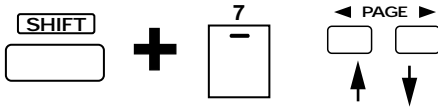

To exit the setting page, press [EXIT].

The first page of each EFX screen will show the currently selected EFX Type, as follows.



EFX On/Off

Hold down [EFFECT SELECT] and press [CARD] to turn EFX on/off.

When EFX is off, the following display will appear.



This setting cannot be stored in a pattern.

4 Band EQ (Modify the Tone)

This is a 4 band (high, midrange x 2, low) stereo equalizer.

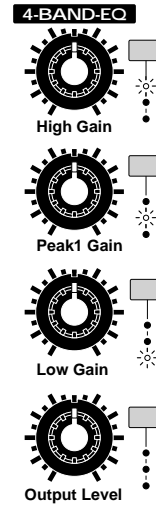
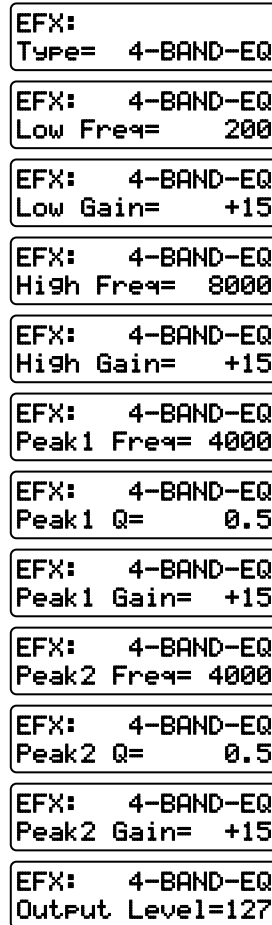

Low Freq (Low Frequency)

Determines the frequency of the low range.
Range: 200, 400 (Hz)

Low Gain [CTRL 3]

Adjusts the volume of the low frequency range.
Range: -15+15

High Freq (High Frequency)

Determines the frequency of the high range.
Range: 4000, 8000 (Hz)

High Gain [CTRL 1]

Adjusts the volume of the high frequency range.
Range: -15+15

Peak1 Freq (Peaking 1 Frequency)

Determines the frequency of midrange 1.
Range: 200-8000 (Hz)

Peak1 Q (Peaking 1Q)

Specifies the width of the frequency range affected by midrange 1.

Range: 0.5–8.0

As this setting is increased, the affected area will become narrower.

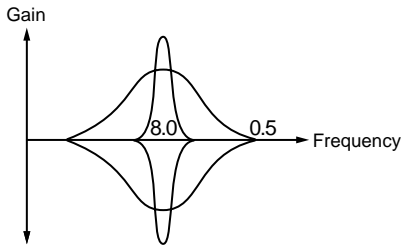

Peak1 Gain (Peaking 1 Gain) [CTRL 2]

Adjusts the volume of midrange 1.

Range: -15–+15

Peak2 Freq (Peaking 2 Frequency)

Determines the frequency of midrange 2.

Range: 200–8000 (Hz)

Peak2 Q (Peaking 2Q)

Specifies the width of the frequency range affected by midrange 2.

Range: 0.5–8.0

As this setting is increased, the affected area will become narrower.

Peak2 Gain (Peaking 2 Gain)

Adjusts the volume of midrange 2.

Range: -15–+15

Output Level [EFX OUTPUT LEVEL]

Adjusts the output level from the 4 band EQ.

Range: 0–127

Spectrum

(Add Character to the Sound)

This is a type of filter, which modifies the tonal character by boosting or cutting specific frequencies. It is similar to an equalizer, but when you wish to add character to the sound, the Spectrum effect will produce a more distinctive result.

EFX:	SPECTRUM
Type=	SPECTRUM
EFX:	SPECTRUM
Low-High=	+15
EFX:	SPECTRUM
Middle Gain=	+15
EFX:	SPECTRUM
Width=	5
EFX:	SPECTRUM
Output Pan=	L64
EFX:	SPECTRUM
Output Level=	127

SPECTRUM

Low-High

Middle Gain

Width

Output Level

Low-High (Low-High Gain) [CTRL 1]

Specifies the volume change at 500Hz and 8000Hz.

Range: -15–+15

Middle (Middle Gain) [CTRL 2]

Specifies the volume change at 1250Hz.

Range: -15–+15

Width (Bandwidth) [CTRL 3]

Specifies the width of the bands in which the volume will be adjusted. (This setting applies to all bands.)

Range: 1–5

Output Pan

Specifies the panning of the sound that is output from the Spectrum effect.

Range: L64–63R

Output Level [EFX OUTPUT LEVEL]

Specifies the volume that is output from the Spectrum effect.

Range: 0–127

4

Enhancer (Add Sparkle to the Sound)

By controlling the overtones of the high frequency range, this effect adds sparkle to the sound, giving it more definition.

Use this effect when you want to make a specific sound stand out from the rest of the ensemble, or to give it greater definition.

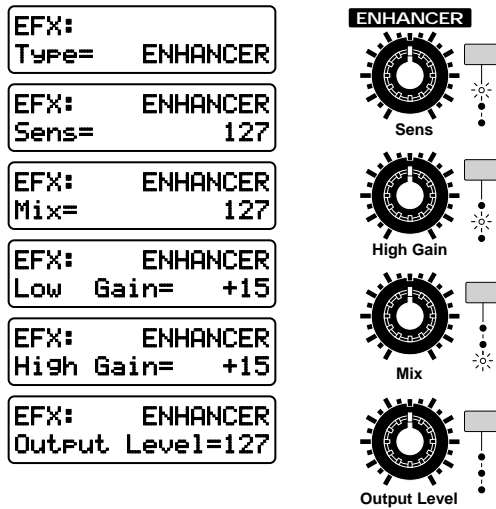

Sens (Sensitivity) [CTRL 1]

Adjusts the depth of the enhancer effect.

Range: 0–127

Mix (Mix Level) [CTRL 3]

Determines the proportion at which the overtones generated by the enhancer will be mixed with the original sound.

Range: 0–127

Low Gain

Specifies how the low frequency range will be boosted or cut.

Range: -15–+15

High Gain [CTRL 2]

Specifies how the high frequency range will be boosted or cut.

Range: -15–+15

Output Level [EFX OUTPUT LEVEL]

Specifies the volume of the output from the Enhancer effect.

Range: 0–127

Overdrive (Distort the Sound Mildly)

This simulates the soft distortion that occurs when you raise the gain of a vacuum tube amp. The effect also contains an amp simulator, and produces the natural distortion that is created by sounds played through a guitar amp. It is suitable for use with guitar and synth-bass sounds.

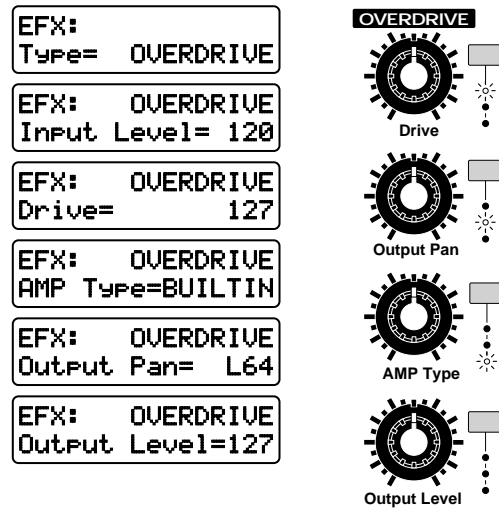

Input Level

Adjusts the level of the input signal.

Range: 0–127

Drive [CTRL 1]

Adjusts the depth of distortion. This will also affect the volume.

Range: 0–127

AMP Type [CTRL 3]

Selection for the type of guitar amp.

Available Settings:

SMALL: small amp

BUILTIN: built-in type amp

2STACK: large double amp stack

3STACK: large triple amp stack

Output Pan [CTRL 2]

Specifies the stereo location of the sound that is output from the Overdrive effect.

Range: L64–63R

Output Level [EFX OUTPUT LEVEL]

Specifies the output volume from the Overdrive effect.

Range: 0–127

Distortion (Distort the Sound Severely)

This effect produces a more severe distortion than the Overdrive effect. It also contains an amp simulator, and produces the natural sound of a guitar amp.

EFX:
Type= DISTORTION

EFX: DISTORTION
Input Level= 120

EFX: DISTORTION
Drive= 127

EFX: DISTORTION
AMP Type=BUILTIN

EFX: DISTORTION
Output Pan= L64

EFX: DISTORTION
Output Level=127

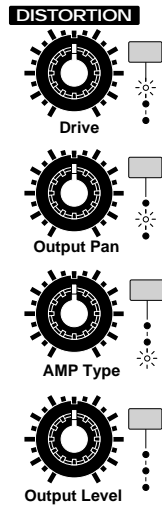

Lo-Fi (Simulate a Lo-Fidelity Sound)

This effect intentionally degrades the audio quality to simulate a Lo-Fi sound. It is particularly effective on drums.

EFX:
Type= Lo-Fi

EFX: Lo-Fi
Bit Down= 7

EFX: Lo-Fi
S-Rate Down= 4

EFX: Lo-Fi
Post Gain= +12

EFX: Lo-Fi
Low Gain= +15

EFX: Lo-Fi
High Gain= +15

EFX: Lo-Fi
Output= MONO

EFX: Lo-Fi
Output Level=127

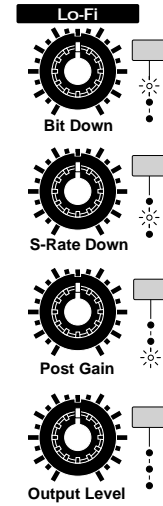

4

Input Level

Adjusts the level of the input signal.

Range: 0–127

Drive [CTRL 1]

Adjusts the depth of distortion. This will also affect the volume.

Range: 0–127

AMP Type [CTRL 3]

Determines the type of guitar amp.

Available Settings:

SMALL: small amp

BUILTIN: built-in type amp

2STACK: large double amp stack

3STACK: large triple amp stack

Output Pan [CTRL 2]

Specifies the stereo location of the sound that is output from the Distortion effect.

Range: L64–63R

Output Level [EFX OUTPUT LEVEL]

Specifies the output volume from the Distortion effect.

Range: 0–127

Bit Down [CTRL 1]

This setting lowers the audio quality.

Range: 0–7

The audio quality will worsen as this setting is increased.

S-Rate Down (Sample Rate Down) [CTRL 2]

This coarsens the output signal.

Range: 32, 16, 8, 4

The sound will become coarser as this setting is lowered.

Post Gain [CTRL 3]

Adjusts the output signal.

Range: 0, +6, +12, +18

Low Gain

Adjusts the boost or cut applied to the low frequency range.

Range: -15–+15

High Gain

Adjusts the boost or cut applied to the high frequency range.

Range: -15–+15

Output

Specifies how the sound will be output.

Range: MONO, STEREO

With a setting of “MONO,” the output sound will be monaural.

Output Level [EFX OUTPUT LEVEL]

Specifies the output volume from the Lo-Fi effect.

Range: 0–127

Noise Generator (Add Various Types of Noise)

In addition to a Lo-Fi effect, this effect also generates various types of noise such as hum, pink noise, and disk noise.

EFX:	NOISE
Type=	NOISE
EFX:	NOISE
Noise Type=	1
EFX:	NOISE
Noise Level=	127
EFX:	NOISE
N Filter=	BYPASS
EFX:	NOISE
Lo-Fi Level=	127
EFX:	NOISE
Output Pan=	L64
EFX:	NOISE
Output Level=	127

The image shows a control panel for the Noise Generator effect. It features a title bar labeled "NOISE" and five knobs, each with a vertical slider to its right. From top to bottom, the knobs are labeled: "N Filter", "Lo-Fi Level", "Noise Level", and "Output Level". The "N Filter" knob is currently set to a low value, while the other knobs are set to higher values. The sliders are represented by small rectangular blocks.

Noise Type

Determines the type of noise (s) that will be generated.

Range: 1–18

Noise Level [CTRL 3]

Specifies the volume of the noise.

Range: 0–127

N Filter (Noise Filter) [CTRL 1]

Adjusts the tone of the noise.

Range: 200–8000 (Hz), BYPASS

If you do not wish to filter the noise, select “BYPASS.”

Lo-Fi Level [CTRL 2]

Increasing this setting will make the original sound rougher.

Range: 0–127

Output Pan

Specifies the stereo location of the sound output from the Noise Generator.

Range: L64–63R

Output Level [EFX OUTPUT LEVEL]

Specifies the output volume of the Noise Generator effect.

Range: 0–127

Noise Type Table

	Hum (50 Hz)	Hum (60 Hz)	Pink	Disc EP	Disc LP	RND Disc
1						O
2			O			
3					O	O
4			O		O	O
5				O		O
6			O	O		O
7	O					
8	O		O			
9	O				O	O
10	O		O		O	O
11	O			O		O
12	O		O	O		O
13		O				
14		O	O			
15		O			O	O
16		O	O		O	O
17		O		O		O
18		O	O	O		O

For each setting, the type (s) of noise marked by “O” will be generated.

Hum (50 Hz): hum noise (50 Hz)

Hum (60 Hz): hum noise (60 Hz)

Pink: pink noise

Disc EP: disc noise (45 RPM)

Disc LP: disc noise (33 RPM)

RND Disc: disc noise generated at random

Radio Tuning (Simulate a Radio Being Tuned)

This effect simulates the sound of a radio being tuned.

```

EFX:
Type= RADIO-TUNG

EFX: RADIO-TUNG
Radio Detune=127

EFX: RADIO-TUNG
Noise Level= 127

EFX: RADIO-TUNG
Low Gain= +15

EFX: RADIO-TUNG
High Gain= +15

EFX: RADIO-TUNG
Output= MONO

EFX: RADIO-TUNG
Output Level=127
    
```

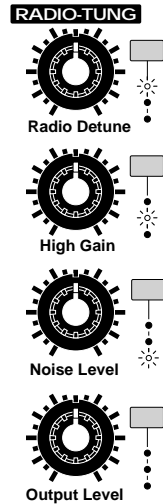

Phonograph (Simulates an Old Record)

This effect mutes the tone and adds disc noise to simulate the sound of music played on an old record player.

```

EFX:
Type= PHONOGRAPH

EFX: PHONOGRAPH
Disc Type= LP

EFX: PHONOGRAPH
D NoiseLevel=127

EFX: PHONOGRAPH
Depth= +15

EFX: PHONOGRAPH
Output Pan= 63R

EFX: PHONOGRAPH
Output Level=127
    
```

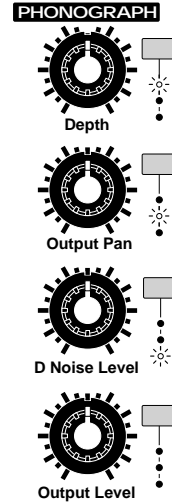

Radio Detune [CTRL 1]

Specifies the frequency being tuned.

Range: 0–127

By rotating the [CTRL 1] knob in real time, you can make the effect appear more real.

Noise Level [CTRL 3]

Specifies the volume of the tuning noise.

Range: 0–127

Low Gain

Adjusts the boost or cut of the low frequency range.

Range: -15–+15

High Gain [CTRL 2]

Adjusts the boost or cut of the high frequency range.

Range: -15–+15

Output

Specifies how the sound will be output.

Range: MONO, STEREO

With a setting of “MONO,” the output will be monaural.

Output Level [EFX OUTPUT LEVEL]

Specifies the output volume of the Radio Tuning effect.

Range: 0–127

Disc Type

Determines the type of disc noise.

Available Settings:

LP: 33 RPM record

EP: 45 RPM record

SP: 78 RPM record

D NoiseLevel (Disc Noise Level) [CTRL 3]

Specifies the volume of the disc noise.

Range: 0–127

Depth [CTRL 1]

Adjusts the tone.

Range: 0–+20

As this value is increased, the high range and low range will be cut, and the mid range will be emphasized.

Output Pan [CTRL 2]

Specifies the stereo location of the output from the Phonograph effect.

Range: L64–63R

Output Level [EFX OUTPUT LEVEL]

Specifies the output volume from the Phonograph effect.

Range: 0–127

Compressor (Make the Volume Level More Consistent)

This effect suppresses loud volume levels and boosts soft volume levels, making the volume more consistent.

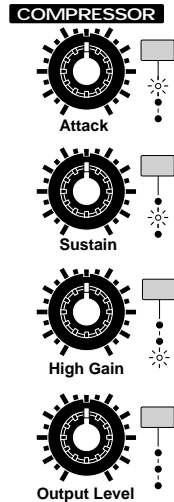
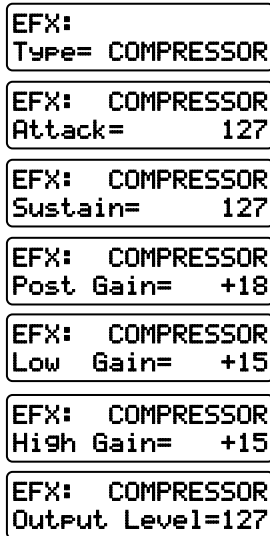

Attack [CTRL 1]

Specifies the duration of the attack when sound is input.

Range: 0–127

Sustain [CTRL 2]

Specifies the time over which low-level sounds will be boosted to reach the specified volume.

Range: 0–127

Post Gain

Adjusts the output signal.

Range: 0, +6, +12, +18

Low Gain

Adjusts the boost or cut of the low frequency range.

Range: -15–+15

High Gain [CTRL 3]

Adjusts the boost or cut of the high frequency range.

Range: -15–+15

Output Level [EFX OUTPUT LEVEL]

Specifies the output volume from the Compressor effect.

Range: 0–127

Limiter (Smooth Out Irregularities in Volume)

This effect compresses the sound when it exceeds a specified volume level, thus preventing distortion.

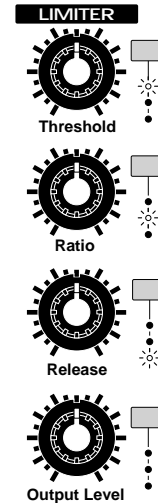
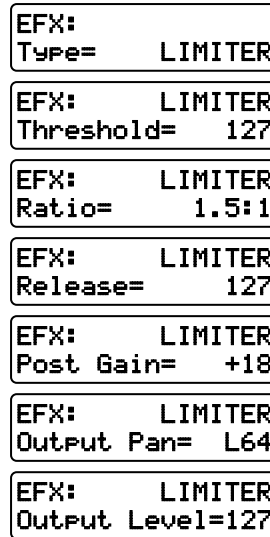

Threshold (Threshold Level) [CTRL 1]

Specifies the volume level at which compression will begin.

Range: 0–127

Ratio (Compression Ratio) [CTRL 2]

Specifies the ratio of compression.

Range: 1.5:1, 2:1, 4:1, 100:1

Release [CTRL 3]

Specifies the time from when the volume drops below the Threshold Level until compression is no longer applied.

Range: 0–127

Post Gain

Adjusts the output signal.

Range: 0, +6, +12, +18

Output Pan

Specifies the stereo location of the output from the Limiter effect.

Range: L64–63R

Output Level [EFX OUTPUT LEVEL]

Specifies the output volume of the Limiter effect.

Range: 0–127

Slicer (Apply Successive Cuts to the Sound)

By applying successive cuts to the sound, this effect turns a conventional sound into a sound that appears to be played as a backing phrase. This is especially effective when applied to sustain-type sounds.

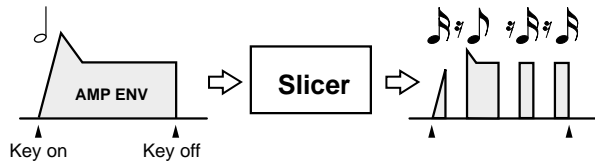

EFX: SLICER
Type= SLICER

EFX: SLICER
O _ O _ O _ O _ O _

Timing PTN

EFX: SLICER
Rate= ♩

EFX: SLICER
[Bar graph showing increasing bar heights]

Accent PTN

EFX: SLICER
Accent Level=100

EFX: SLICER
Attack= 10

EFX: SLICER
Output Level=127

SLICER

Timing PTN [Dial]

Accent PTN [Dial]

Rate [Dial]

Output Level [Dial]

Rate [CTRL 3]

Determines the note value unit which will be cut.

Range: ♩ ♪ ♫

The sixteen symbols shown in the lower line of the Timing Pattern and Accent Pattern pages correspond to the note value that you specify. For example, if you have selected whole notes, each of the sixteen symbols will represent the duration of a 16th note. With this setting, the sound will be cut as follows.

EFX: SLICER
O _ O _ O _ O _ O _



Accent PTN (Accent Pattern) [CTRL 2]

Specifies the location of the accents.

Range: 16 types

The lower line of the display will show a pattern to indicate how accents will occur.

By holding down [EDIT] as you rotate the [VALUE], you can view the Timing Pattern as you select the Accent Pattern.

Accent Level

Adjusts the volume of the accents.

Range: 0-127

As this setting is increased, the accent will be more pronounced.

Attack

Adjusts the attack speed of the sound.

Range: 1-10

As this setting is increased, the attack will become faster.

Output Level [EFX OUTPUT LEVEL]

Adjusts the output volume from the Slicer effect.

Range: 0-127

Timing PTN (Timing Pattern) [CTRL 1]

Select a pattern to specify the timing at which the sound will be cut.

Range: 34 types

The lower line of the display will show the pattern that will determine when the sound is cut. The sound will be cut at locations without a "O" symbol.

By holding down [EDIT] and rotating the [VALUE] dial, you can select the timing pattern while viewing the accent pattern.

4

Resonance [CTRL 3]

This setting emphasizes the frequency range in the vicinity of the center frequency.

Range: 0–127

Mix (Mix Level)

Adjusts the proportion of the original sound that will be combined with the phase-shifted sound.

Range: 0–127

Output Pan

Specifies the stereo location of the output from the Phaser effect.

Range: L64–63R

Output Level [EFX OUTPUT LEVEL]

Specifies the output volume of the Phaser effect.

Range: 0–127

4

Chorus (Add Spaciousness and Depth to the Sound)

This effect creates an impression of multiple sound sources in unison (Chorus effect), giving spaciousness and depth to the sound.

EFX:	CHORUS
Type=	CHORUS
EFX:	CHORUS
Pre Delay=	0.0
EFX:	CHORUS
Rate=	0.1
EFX:	CHORUS
Depth=	127
EFX:	CHORUS
Phase=	180
EFX:	CHORUS
Filter Type=	LPF
EFX:	CHORUS
Cutoff=	8000
EFX:	CHORUS
Balance=	D50:50E
EFX:	CHORUS
Output Level=	127

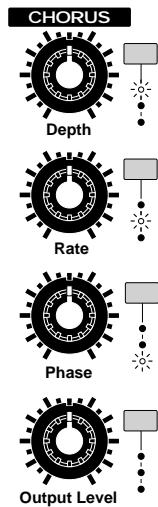

Rate [CTRL 2]

Specifies the frequency of modulation.

Range: 0.1–10.0, F ♯
2MES 3MES 4MES 8MES 16MES

If a note value or measure is selected as the value of this parameter, the Rate will synchronize with the tempo of the pattern at intervals of the specified note value or measure.

If you wish to use the [CTRL 2 (RATE)] knob to select a note value or measure, hold down [SHIFT] and rotate the [CTRL 2 (RATE)] knob.

Depth [CTRL 1]

Specifies the depth of modulation.

Range: 0–127

Phase [CTRL 3]

Adjusts the spaciousness of the sound.

Range: 0–180

As this setting is increased, the sound will spread more toward left and right.

Filter Type

Determines the type of filter that will be applied to the chorus sound.

Available Settings:

OFF: A filter will not be used.

LPF: The frequency range above the cutoff frequency will be cut.

HPF: The frequency range below the cutoff frequency will be cut.

Cutoff (Cutoff Frequency)

Specifies the cutoff frequency of the filter.

Range: 200–8000 (Hz)

Balance (Effect Balance)

Adjusts the volume balance between the original sound and the chorus sound.

Range: D100:0E–D0:100E

With a setting of “D100:0E,” no chorus sound will be output.

Output Level [EFX OUTPUT LEVEL]

Specifies the output volume from the stereo chorus.

Range: 0–127

Pre Delay (Pre Delay Time)

Specifies the time from the original sound until when the chorus sound is heard.

Range: 0.0–100

Space-D (Add Transparent Depth)

This is a type of chorus, but unlike a conventional chorus, it does not create a sense of modulation. It produces a chorus effect with an impression of transparency.

EFX:	SPACE-D
Type=	SPACE-D
EFX:	SPACE-D
Pre Delay=	0.0
EFX:	SPACE-D
Rate=	0.1
EFX:	SPACE-D
Depth=	127
EFX:	SPACE-D
Phase=	180
EFX:	SPACE-D
Low Gain=	+15
EFX:	SPACE-D
High Gain=	+15
EFX:	SPACE-D
Balance=	D50:50E
EFX:	SPACE-D
Output Level=	127

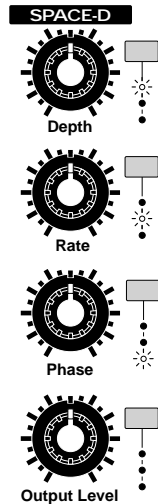

Pre Delay (Pre Delay Time)

Specifies the time from the original sound until the chorus sound is heard.

Range: 0.0–100

Rate [CTRL 2]

Specifies the rate of modulation.

Range: 0.1–10.0, $\frac{1}{2}$ $\frac{1}{4}$ $\frac{1}{8}$ $\frac{1}{16}$ $\frac{1}{32}$ $\frac{1}{64}$ $\frac{1}{128}$ $\frac{1}{256}$ $\frac{1}{512}$ $\frac{1}{1024}$ $\frac{1}{2048}$ $\frac{1}{4096}$
 2MES 3MES 4MES 8MES 16MES

If a note value or measure is selected as the value of this parameter, the Rate will synchronize with the tempo of the pattern at intervals of the specified note value or measure.

If you wish to use the [CTRL 2 (RATE)] knob to select a note value or measure, hold down [SHIFT] and rotate the [CTRL 2 (RATE)] knob.

Depth [CTRL 1]

Specifies the depth of modulation.

Range: 0–127

Phase [CTRL 3]

Adjusts the spread of the sound.

Range: 0–180

As this value is increased, the sound will have a broader left/right spread.

Low Gain

Adjusts the boost or cut of the low frequency range.

Range: -15–+15

High Gain

Adjusts the boost or cut of the high frequency range.

Range: -15–+15

Balance (Effect Balance)

Adjusts the volume balance between the original sound and the chorus sound.

Range: D100:0E–D0:100E

With a setting of “D100:0E” the chorus sound will not be heard.

Output Level [EFX OUTPUT LEVEL]

Specifies the output volume from the Space-D effect.

Range: 0–127

Tetra Chorus (Layer Chorus Sounds to Add Spaciousness)

This effect layers four chorus sounds to produce even more depth and spaciousness than a conventional chorus.

EFX:	TETRA-CHORS
Type=	TETRA-CHORS
EFX:	TETRA-CHORS
Pre Delay=	0.0
EFX:	TETRA-CHORS
Rate=	0.1
EFX:	TETRA-CHORS
Depth=	127
EFX:	TETRA-CHORS
Pre Dly Devi=	20
EFX:	TETRA-CHORS
Depth Devi=	+20
EFX:	TETRA-CHORS
Pan Devi=	20
EFX:	TETRA-CHORS
Balance=	D50:50E
EFX:	TETRA-CHORS
Output Level=	127

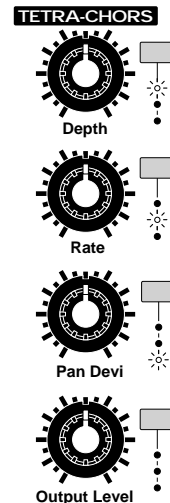

Pre Delay (Pre Delay Time)

Specifies the time from the original sound until the chorus sound is heard.

Range: 0.0–100

Rate [CTRL 2]

Specifies the rate of modulation.

Range: 0.1–10.0,  2MES 3MES 4MES 8MES 16MES

If a note value or measure is selected as the value of this parameter, the Rate will synchronize with the tempo of the pattern at intervals of the specified note value or measure.

If you wish to use the [CTRL 2 (RATE)] knob to select a note value or measure, hold down [SHIFT] and rotate the [CTRL 2 (RATE)] knob.

Depth [CTRL 1]

Specifies the depth of modulation.

Range: 0–127

Pre Dly Devi (Pre Delay Deviation)

Adjusts the difference in pre delay between each of the chorus sounds.

Range: 0–20

Depth Devi (Depth Deviation)

Adjusts the difference in modulation depth between each of the chorus sounds.

Range: -20–+20

Pan Devi (Pan Deviation) [CTRL 3]

Adjusts the pan difference between each chorus sound.

Range: 0–20

As this value is increased, the sound will have a greater left/right spread.

Balance (Effect Balance)

Specifies the volume balance between the original sound and the chorus sound.

Range: D100:0E–D0:100E

With a setting of “D100:0E” no chorus sound will be output.

Output Level [EFX OUTPUT LEVEL]

Specifies the output volume from the Tetra Chorus effect.

Range: 0–127

Flanger (Add Metallic Resonance to the Sound)

This creates a sharper and more mechanical sound than the phaser. It can add a metallic resonance to the sound, or produce an effect that sounds like an jet airplane taking off and landing.

EFX: FLANGER
Type= FLANGER

EFX: FLANGER
Pre Delay= 0.0

EFX: FLANGER
Rate= 0.1

EFX: FLANGER
Depth= 127

EFX: FLANGER
Feedback= +98

EFX: FLANGER
Phase= 180

EFX: FLANGER
Filter Type= LPF

EFX: FLANGER
Cutoff= 8000

EFX: FLANGER
Balance= D50:50E

EFX: FLANGER
Output Level=127

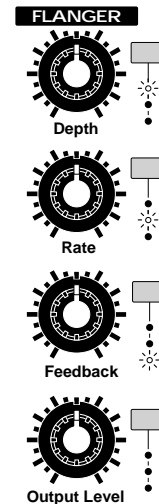

Pre Delay (Pre Delay Time)

Specifies the time from the original sound until the flanger sound is heard.

Range: 0.0–100

Rate [CTRL 2]

Specifies the rate of modulation.

Range: 0.1–10.0,  2MES 3MES 4MES 8MES 16MES

If a note value or measure is selected as the value of this parameter, the Rate will synchronize with the tempo of the pattern at intervals of the specified note value or measure.

If you wish to use the [CTRL 2 (RATE)] knob to select a note value or measure, hold down [SHIFT] and rotate the [CTRL 2 (RATE)] knob.

Depth [CTRL 1]

Specifies the depth of modulation.

Range: 0–127

4

Feedback (Feedback Level) [CTRL 3]

Specifies the proportion of the flanger sound that is fed back into the input.

Range: 0–+98 (%)

Phase

Adjusts the width of the sound.

Range: 0–180

As this setting is increased, the left/right spread of the sound will increase.

Filter Type

Determines the type of filter that will be applied to the flanger sound.

Available Settings:

OFF: A filter will not be used.

LPF: The frequency range above the cutoff frequency will be cut.

HPF: The frequency range below the cutoff frequency will be cut.

Cutoff (Cutoff Frequency)

Specifies the cutoff frequency of the filter.

Range: 200–8000 (Hz)

Balance (Effect Balance)

Adjusts the volume balance between the original sound and the flanger sound.

Range: D100:0E–D0:100E

With a setting of “D100:0E,” no flanger sound will be output.

Output Level [EFX OUTPUT LEVEL]

Specifies the output volume from the stereo flanger.

Range: 0–127

Step Flanger (Add Metallic Resonance to the Sound While Changing the Pitch in Steps)

This is a flanger that changes the pitch of the sound in steps. The frequency of pitch change can also be synchronized to the tempo.

EFX: ST-FLANGER
Type= ST-FLANGER

EFX: ST-FLANGER
Pre Delay= 0.0

EFX: ST-FLANGER
Rate= 0.1

EFX: ST-FLANGER
Depth= 127

EFX: ST-FLANGER
Feedback= +98

EFX: ST-FLANGER
Phase= 180

EFX: ST-FLANGER
Step Rate= 10.0

EFX: ST-FLANGER
Balance= D50:50E

EFX: ST-FLANGER
Output Level=127

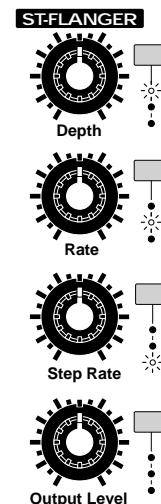
**Pre Delay (Pre Delay Time)**

Specifies the time from the original sound until the flanger sound is heard.

Range: 0.0–100

Rate [CTRL 2]

Specifies the rate of modulation.

Range: 0.1–10.0, 2MES 3MES 4MES 8MES 16MES

If a note value or measure is selected as the value of this parameter, the Rate will synchronize with the tempo of the pattern at intervals of the specified note value or measure.

If you wish to use the [CTRL 2 (RATE)] knob to select a note value or measure, hold down [SHIFT] and rotate the [CTRL 2 (RATE)] knob.

Depth [CTRL 1]

Specifies the depth of modulation.

Range: 0–127

Feedback (Feedback Level)

Specifies the proportion of the flanger sound which will be fed back into the input.

Range: 0–+98 (%)

Phase

Adjusts the spread of the sound.

Range: 0–180

As this value is increased, the left/right spread of the sound will increase.

Step Rate [CTRL 3]

Specifies the rate at which the pitch will change.

Range: 0.05–10.0 (Hz)



If a note value is selected as the value of this parameter, the Step Rate will synchronize with the tempo of the pattern at intervals of the specified note value.

If you wish to use the [CTRL 3 (STEP RATE)] knob to select a note value, hold down [SHIFT] and rotate the [CTRL 3 (STEP RATE)] knob.

Balance (Effect Balance)

Adjusts the volume balance between the original sound and the flanger sound.

Range: D100:0E–D0:100E

With a setting of “D100:0E” no flanger sound will be output.

Output Level [EFX OUTPUT LEVEL]

Specifies the output volume of the Step Flanger effect.

Range: 0–127

Short Delay (Add Echoes to the Sound)

This is a short delay which allows you to set the left and right delay times independently. You can also move the panning of the delay sound in synchronization with the tempo.

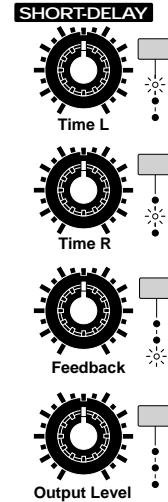
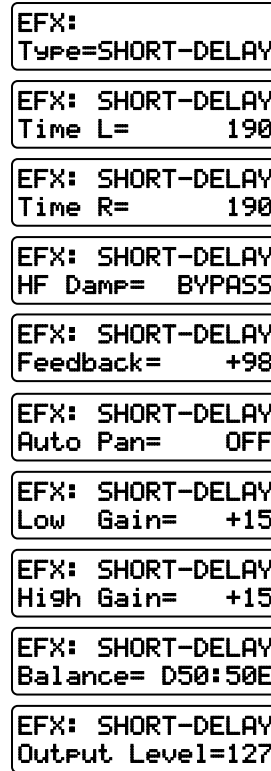

Time L (Delay Time Left) [CTRL 1]

Specifies the time from the original sound until the left delay sound is heard.

Range: 0.1–190

Time R (Delay Time Right) [CTRL 2]

Specifies the time from the original sound until the right delay sound is heard.

Range: 0.1–190

HF Damp

Determines the frequency at which the high frequency portions of the delay sound will be cut.

Range: 200–8000 (Hz), BYPASS

As this parameter is set to a lower frequency, more of the high range will be cut, making the delay sound more muted in tone.

If you do not wish to cut the high frequency range, select “BYPASS.”

Feedback (Feedback Level) [CTRL 3]

Adjusts the number of delay repeats.

Range: 0–+98 (%)

Auto Pan

This setting causes the panning of the delay sound to move in synchronization with the tempo.

Range: OFF, 2MES 3MES 4MES 8MES 16MES

Low Gain

Adjusts the boost or cut of the low frequency range.

Range: -15--+15

High Gain

Adjusts the boost or cut of the high frequency range.

Range: -15--+15

Balance (Effect Balance)

Adjusts the volume balance between the original sound and the delay sound.

Range: D100:0E-D0:100E

With a setting of "D100:0E" no delay sound will be output.

Output Level [EFX OUTPUT LEVEL]

Specifies the output volume from the Short Delay effect.

Range: 0-127

Auto Pan (Automatically Move the Stereo Location)

This effect automatically moves the stereo location of the sound. You can cause the sound to be panned left and right in time with low notes such as a Bass Drum, or in synchronization with the tempo of the pattern.

EFX:	AUTO-PAN
Type=	AUTO-PAN
EFX:	AUTO-PAN
LFO Type=	TRI
EFX:	AUTO-PAN
Rate=	0.1
EFX:	AUTO-PAN
Bass Sense=	OFF
EFX:	AUTO-PAN
Depth=	127
EFX:	AUTO-PAN
Low Gain=	+15
EFX:	AUTO-PAN
High Gain=	+15
EFX:	AUTO-PAN
Output Level=	127

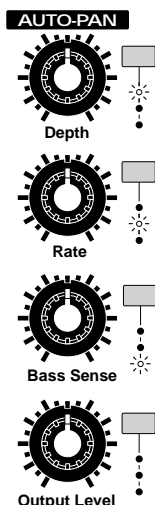

LFO Type

Determines the waveform that will be used to pan the sound to left and right.

Range: TRI, TRP, SIN, SAW1, SAW2, SQR

Rate [CTRL 2]

Specifies the rate at which the pan will be moved.

Range: 0.1-10.0 (Hz)

2MES 3MES 4MES 8MES 16MES

If a note value or measure is selected as the value of this parameter, the Rate will synchronize with the tempo of the pattern at intervals of the specified note value or measure.

If you wish to use the [CTRL 2 (RATE)] knob to select a note value or measure, hold down [SHIFT] and rotate the [CTRL 2 (RATE)] knob.

* When the Bass Sensitivity parameter is set to "MODE2," the Rate setting will be ignored.

Bass Sens (Bass Sensitivity) [CTRL 3]

Make this setting when you wish to shift the panning at the timing of the bass notes.

Available Settings:

OFF: The panning will change at the speed specified by Rate.

MODE1: The Rate value will increase at the timing of the bass notes.

MODE2: The panning will change at the timing of the bass notes.

Depth [CTRL 1]

Specifies the depth of panning.

Range: 0-127

Low Gain

Adjusts the boost or cut of the low frequency range.

Range: -15--+15

High Gain

Adjusts the boost or cut of the high frequency range.

Range: -15--+15

Output Level [EFX OUTPUT LEVEL]

Specifies the output volume of the Auto Pan effect.

Range: 0-127

Feedback Pitch Shifter (Skew the Pitch)

This effect shifts the pitch of the original sound and layers it with the original sound. It can be used to play unison lines at an interval of an octave or fifth, or to layer a slightly pitch-shifted with the original sound to create a chorus effect.

```

EFX:
Type= FB-P-SHIFT

EFX: FB-P-SHIFT
Coarse= +12

EFX: FB-P-SHIFT
Fine= +50

EFX: FB-P-SHIFT
Output Pan= L64

EFX: FB-P-SHIFT
Pre Delay= 0.0

EFX: FB-P-SHIFT
Mode= 1

EFX: FB-P-SHIFT
Feedback= +98

EFX: FB-P-SHIFT
Low Gain= +15

EFX: FB-P-SHIFT
High Gain= +15

EFX: FB-P-SHIFT
Balance= D50:50E

EFX: FB-P-SHIFT
Output Level=127
    
```

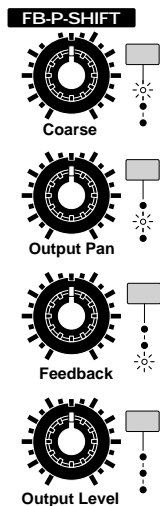

4

Coarse (Coarse Pitch) [CTRL 1]

Specifies the amount of pitch shift relative to the original sound, in semitone steps.

Range: -24+12

Fine (Fine Pitch)

Adjusts the amount of pitch shift in 2-cent steps.

Range: -100+100

Output Pan [CTRL 2]

Determines the stereo location of the pitch-shifted sound.

Range: L64-63R

Pre Delay (Pre Delay Time)

Specifies the time from the original sound until the pitch-shifted sound is heard.

Range: 0.0-100

Mode (Pitch Shifter Mode)

Specifies how the pitch will be shifted.

Range: 1-5

As this setting is increased, the response will be slower, but the sound will be more stable.

Feedback (Feedback Level) [CTRL 3]

Specifies the proportion of the pitch-shifted sound that will be fed back into the input.

Range: 0-+98 (%)

Low Gain

Adjusts the boost or cut of the low frequency range.

Range: -15+15

High Gain

Adjusts the boost or cut of the high frequency range.

Range:-15+15

Balance (Effect Balance)

Specifies the volume balance between the original sound and the pitch-shifted sound.

Range: D100:0E-D0:100E

When the setting is "D100:0E" the pitch-shifted sound will not be output.

Output Level [EFX OUTPUT LEVEL]

Specifies the output volume of the Feedback Pitch Shifter effect.

Range: 0-127

Reverb (Add Reverberation)

This effect adds reverberation and ambiance to the sound, creating spatial depth.

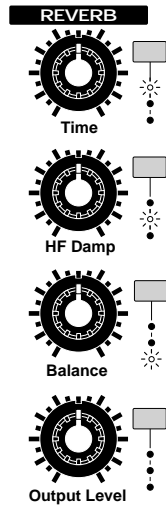
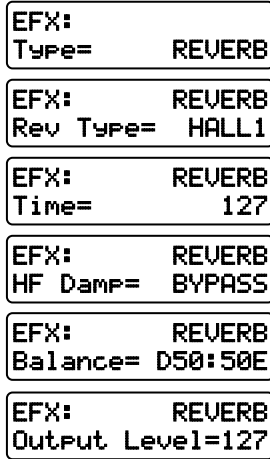

Rev Type (Reverb Type)

You can select one of the following six basic types of reverb.

Available Settings:

- ROOM1: Reverb with short decay and high density.
- ROOM2: Reverb with short decay and low density.
- STAGE1: Reverb with much subsequent reverberation.
- STAGE2: Reverb with strong early reflections.
- HALL1: Clear-sounding reverb.
- HALL2: Rich-sounding reverb.

Time (Reverb Time) [CTRL 1]

Specifies the duration of the reverberation.
Range: 0–127

HF Damp [CTRL 2]

Determines the frequency at which the high frequency portions of the reverberation will be cut.

Range: 200–8000 (Hz), BYPASS

As this parameter is set to a lower frequency, more of the high range will be cut, making the reverberation more muted in tone.

If you do not wish to cut the high frequency range, select “BYPASS.”

Balance (Effect Balance) [CTRL 3]

Specifies the volume balance between the original sound and the reverberation.

Range: D100:0E–D0:100E

With a setting of “D100:0E” no reverb sound will be output.

Output Level [EFX OUTPUT LEVEL]

Specifies the output volume from the reverb effect.
Range: 0–127

Gated Reverb (Sharply Cut the Reverberation)

This is a type of reverb, in which the reverberation is cut off before the natural completion of its decay.

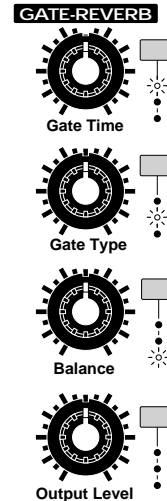
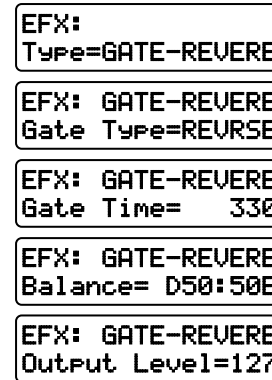

Gate Type (Gate Reverb Type) [CTRL 2]

Select one of the following four basic types of gated reverb.

Available Settings:

- NORMAL: Normal gated reverb
- REVRSE: Reverse-playback reverb
- SWEEP1: The reverberation will sweep from right to left.
- SWEEP2: The reverberation will sweep from left to right.

Gate Time (Gate Reverb Time) [CTRL 1]

Specifies the time from when the reverberation begins until it ends.

Range: 5–330

Balance (Effect Balance) [CTRL 3]

Specifies the volume balance between the original sound and the reverberation.

Range: D100:0E–D0:100E

With a setting of “D100:0E” no reverberation will be output.

Output Level [EFX OUTPUT LEVEL]

Specifies the output volume of the Gate Reverb effect.
Range: 0–127

Applying EFX/Specifying the Output Destination for Each Part (Part EFX/Output Assign)

For each part, you can turn EFX on/off, and specify the output jack from which the sound will be output.

1. Press [MIXER SELECT] several times to make the EFX/OUT indicator light.
2. Use part sliders [R]Ø[7] to adjust the Part EFX Balance for each part.

Available Settings:

DRY (D): EFX will not be applied, and the sound will be output from the MIX jacks in stereo.

EFX (E): EFX will be applied, and the sound will be output from the MIX jacks in stereo.

DIR1 (1): The sound will be output in stereo from the DIRECT 1 jacks.

DIR2 (2): The sound will be output in stereo from the DIRECT 2 jacks.

RHY (R): The sound will be output according to the settings of the Rhythm Tone EFX/Output Assign, the Rhythm Tone Reverb Level, and the Rhythm Tone Delay Level parameters of the selected rhythm set (only for the Rhythm Part).

4

📖 “R.TONE EFX/Out (Rhythm Tone EFX/Output Assign)” (p. 76)

By moving the slider normally you can select “DRY” or “EFX.”

By holding down [SHIFT] and moving the slider, you can select “DRY-DIR2 (RHY).”

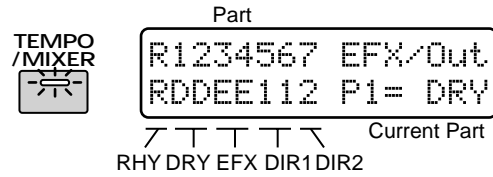
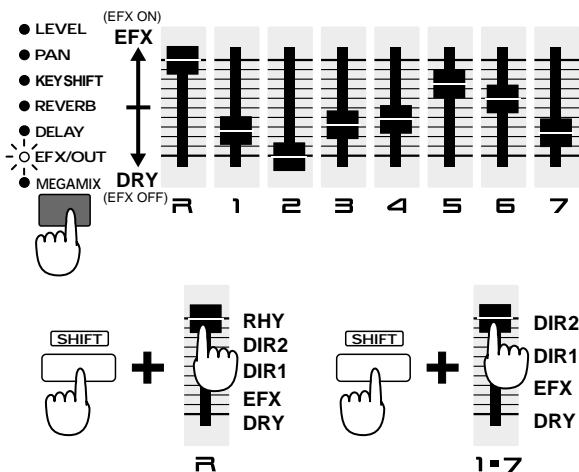

If you press [TEMPO/MIXER] to select the Part Mixer display, the values of each part will be displayed graphically.

* The reverb/delay/EFX effects will not apply to the sound that is output from the DIRECT 1/2 jacks.

* If the EFX Output Level setting is low, the sound of the patch/rhythm set to which EFX is applied will not be heard (p. 86).

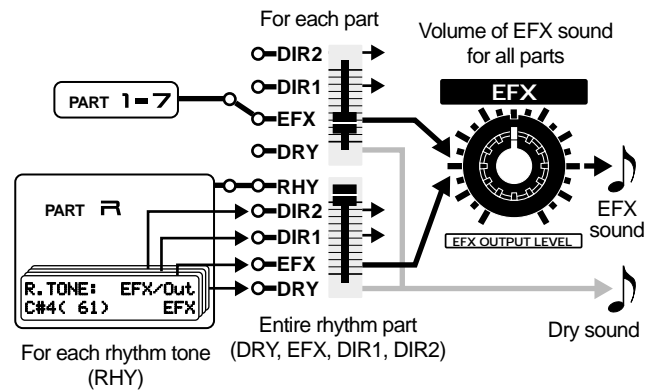

If you wish to apply EFX or adjust the reverb/delay volume for individual rhythm tones, or to output only a specific rhythm tone from the DIR1/2 jacks, select “RHY.”

📖 •To adjust the reverb volume for individual rhythm tones...

☞ “R.TONE Rev Level (Rhythm Tone Reverb Level)” (p. 76)

•To adjust the delay volume for individual rhythm tones...

☞ “R.TONE Dly Level (Rhythm Tone Delay Level)” (p. 76)

•To turn EFX on/off and specify the output destination for individual rhythm tones...

☞ “R.TONE EFX/Out (Rhythm Tone EFX/Output Assign)” (p. 76)

By using the arpeggiator, you can produce an arpeggio (broken chord) simply by holding down the chord. For example, if you hold down a C major chord as follows, an arpeggio of C3, E3, G3, E3, C3, E3, G3.... will be played.

In the case of

Arpeggio Style: 1/4

Octave Range: 0

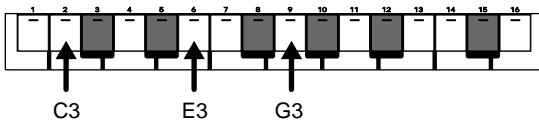
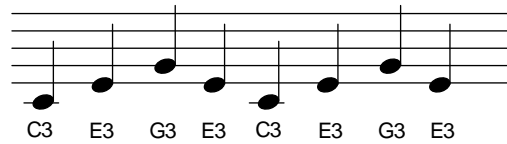

Playing an Arpeggio

1. Make sure that both the [PTN CALL] and [RPS] indicators are dark.

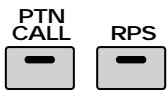

2. Use [PART SELECT] and the PART buttons to select the part which will play the arpeggio.

3. Press ARPEGGIATOR [ON].

The indicator will light, and the arpeggiator will be turned on.



4. Play the keyboard pad, and the notes will be played as an arpeggio by the selected part.

If a MIDI keyboard is connected, you can play it to produce arpeggios using the sound of the part which was selected by the PART button.

* The tempo of the arpeggio will be synchronized to the tempo of the pattern. If you wish to change the speed of the arpeggio, change the tempo of the pattern.

"Adjusting the Tempo" (p. 20)

Arpeggio hold

If you press [HOLD] to make the indicator light, the arpeggio will continue playing even after you take your hand off of the keyboard pads. If you play a different chord or key while the arpeggio is being held, the arpeggio will change accordingly.

You can also connect a pedal switch (optional: DP-2, DP-6, FS-5U etc.) and set the System parameter "Pedal Assign" to "HOLD" so that the pedal switch will hold the arpeggio in the same way.

"Specifying How the Pedal will Function" (p. 165)

Creating an Arpeggio Pattern

When you wish to make arpeggiator settings, you will first select an Arpeggio Style. When you select a style, optimal values will be set for the four parameters "Accent Rate," "Motif," "Beat Pattern," and "Shuffle Rate." You can adjust parameters such as Accent Rate and Octave Range to modify the pattern to your taste. If this is not enough, you can also make more detailed settings.

"Making More Detailed Settings" (p. 107)

The arpeggiator settings you modify can be stored as a User Style.

"Saving Arpeggio Settings That You Have Modified (Arpeggio Write)" (p. 108)

* The settings which can be made for "Beat Pattern" will depend on the selected style.

Selecting the Arpeggio Style (Arpeggio Style)

Specifies the basic way in which the arpeggio will be played. Select one of the following 53 types.

1. Hold down the **ARPEGGIATOR [ON]** button, and use **[INC]** **[DEC]** or the **[VALUE]** dial to select the style.

While you hold down the button, the display will indicate the currently-selected style.

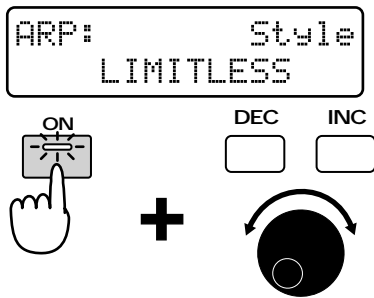

5

Available Settings:

- 1/4: The rhythm will be divided in quarter notes.
- 1/6: The rhythm will be divided in quarter note triplets.
- 1/8: The rhythm will be divided in eighth notes.
- 1/12: The rhythm will be divided in eighth note triplets.
- 1/16: The rhythm will be divided in 16th notes.
- 1/32: The rhythm will be divided in 32nd notes.
- PORTAMENTO A, B: A style using the portamento effect.
- GLISSANDO: A glissando style.
- SEQUENCE A–D: Styles for sequenced patterns.
- ECHO: An echo-like style.
- SYN BASS, HEAVY SLAP, LIGHT SLAP, WALK BASS: Styles appropriate for bass playing.
- RHYTHM GTR 1–5: Styles for guitar cutting. Styles 2–5 are effective when 3–4 notes are held.
- 3 FINGER: Three-finger guitar style.
- STRUMMING GTR: A style simulating a guitar chord strummed upward (downward). Effective when 5–6 notes are held.
- PIANO BACKING, CLAVI CHORD: Styles for keyboard instrument backing.
- WALTZ, SWING WALTZ: Styles in triple meter.
- REGGAE: A reggae-type style. Effective when 3 notes are held.
- PERCUSSION: A style suitable for percussive instrument sounds.
- HARP: The playing style of a harp.
- SHAMISEN: The playing style of a Shamisen.
- BOUND BALL: A style suggestive of a bouncing ball.
- RANDOM: A style in which the notes sound in random order.

BOSSANOVA: A style with bossanova guitar cutting. Hold 3–4 notes for best results. You can increase the BPM and use this as a Samba.

SALSA: Typical salsa style. Hold 3–4 notes for best results.

MAMBO: Typical mambo style. Hold 3–4 notes for best results.

LATIN PERCUSSION: A rhythm style with Latin percussion instruments such as Clave, Cowbell, Clap, Bongo, Conga, Agogo etc.

SAMBA: Typical samba style. Use for rhythm patterns or bass lines.

TANGO: Typical tango rhythm style. Hold the root, 3rd and 5th of a triad etc. for best results.

HOUSE: A style for house piano backing. Hold 3–4 notes for best results.

LIMITLESS: The settings of all parameters can be freely combined without restriction.

USER STYLE 1–10: Arpeggio settings can be modified and saved in one of these user styles.

Adding Expression to the Arpeggio (Accent Rate)

By modifying the accent strength and note length, you can change the sense of groove of the arpeggio.

1. Make sure that the **[FUNC]** indicator is dark.
2. Rotate the **[ACCENT RATE]** knob to set the accent rate.



Range: 0–100

Rotating the knob clockwise will strengthen the sense of groove. Rotating the knob counterclockwise will decrease the amount of expression.

Changing the Pitch Range of the Arpeggio (Octave Range)

You can specify the pitch range in which the arpeggio will be developed, in steps of one octave.

1. Press **[FUNC]** to make the button indicator blink.
2. Rotate the **[RANGE]** knob to set the Octave Range.

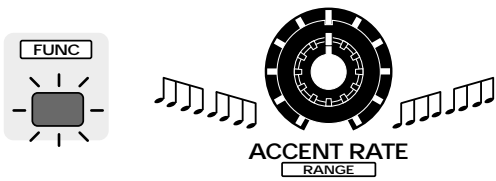

Range: -3--+3

Rotating the knob clockwise will cause the pitch range to be extended upward from the notes which you play. Rotating the knob counterclockwise will extend the pitch range downward.

Making More Detailed Settings

Normally you will create the arpeggio pattern by adjusting the three parameters “Arpeggio Style,” “Accent Rate,” and “Octave Range.” However by modifying the settings of additional parameters, you can create arpeggio patterns that are even richer in variation.

1. Hold down [SHIFT] and press keyboard pad [1].

The setting page for the ARPEGGIO section will appear in the display.

2. Use PAGE [<] [>] to select parameters within the section, and make settings.

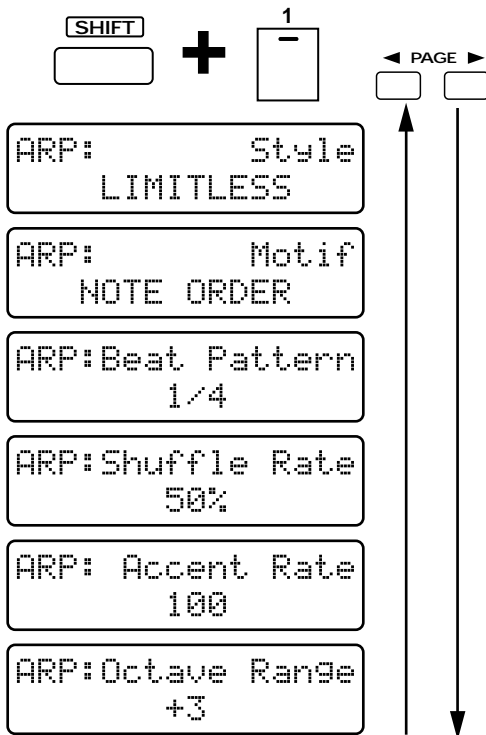

To exit the setting page, press [EXIT].

Style (Arpeggio Style)

This is the setting page for “Selecting the Arpeggio Style (Arpeggio Style)” (p. 106).

Motif

Specifies the order in which the notes of the chord will be sounded.

Available Settings:

SINGLE UP: Notes you press will be sounded individually, beginning from low to high.

SINGLE DOWN: Notes you press will be sounded individually, from high to low.

SINGLE UP&DW: Notes you press will be sounded individually, from low to high, and then back down from high to low.

SINGLE RANDOM: Notes you press will be sounded individually, in random order.

DUAL UP: Notes you press will be sounded two at a time, beginning from low to high.

DUAL DOWN: Notes you press will be sounded two at a time, beginning from high to low.

DUAL UP&DW: Notes you press will be sounded two at a time, from low to high, and then back down from high to low.

DUAL RANDOM: Notes you press will be sounded two at a time, in random order.

TRIPLE UP:Notes you press will sound three at a time, from low to high.

TRIPLE DOWN:Notes you press will sound three at a time, from high to low.

TRIPLE UP&DOWN:Notes you press will sound three at a time, from low to high and then back down from high to low.

TRIPLE RANDOM:Notes you press will sound three at a time, in random order.
NOTE ORDER: Notes you press will be sounded in the order in which you pressed them. By pressing the notes in the appropriate order you can produce melody lines. Up to 128 notes will be remembered.

NOTE ORDER: Notes you press will be sounded in the order in which you pressed them. By pressing the notes in the appropriate order you can produce melody lines. Up to 128 notes will be remembered.

GLISSANDO: Each chromatic step between the highest and lowest notes you press will sound in succession, repeating upward and downward. Press only the lowest and the highest notes.

CHORD: All notes you press will sound simultaneously.

BASS+CHORD 1-5: The lowest of the notes you play will sound, and the remaining notes will sound as a chord.

BASS+UP 1-8: The lowest of the notes you play will sound, and the remaining notes will be arpeggiated.

BASS+RND 1-3: The lowest of the notes you play will sound, and the remaining notes will sound in random order.

TOP+UP 1-6: The highest of the notes you play will sound, and the remaining notes will be arpeggiated.

BASS+UP+TOP: The highest and the lowest of the notes you play will sound, and the remaining notes will be arpeggiated.

Beat Pattern

This allows you to select the Beat Pattern. It will affect the accent location and note length, causing the beat (rhythm) to change.

Range: 1/4, 1/6, 1/8, 1/12, 1/16 1-3, 1/32 1-3, PORTA-A 1-11, PORTA-B 1-15, SEQ-A 1-7, SEQ-B 1-5, SEQ-C 1, 2, SEQ-D 1-8, ECHO 1-3, MUTE 1-16, STRUM 1-8, REGGAE 1, 2, REF 1, 2, PERC 1-4, WALKBS, HARP, BOUND, RANDOM, BOSSA NOVA, SALSA 1-4, MAMBO 1-2, CLAVE, REV CLA, GUILO, AGOGO, SAMBA, TANGO 1-4, HOUSE 1, 2

.....
 If "PORTA-A 1-11, PORTA-B 1-15" is selected as the Beat Pattern, the Patch parameter Portamento Time (p. 58) will control the speed of portamento. Adjust the portamento time as appropriate for the playback tempo. (It is not necessary to turn portamento on.)

* The parameters which can be set will depend on the currently-selected Arpeggio Style.

Shuffle Rate

This setting lets you modify the note timing to create shuffle rhythms.

Range: 50-90 (%)

With a setting of 50%, the notes will sound at equal spacing. As this value is increased, the notes will become more "bouncy," as if they were dotted notes.

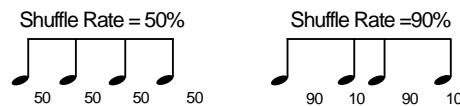

* If the Beat Pattern setting is "1/4," shuffle will not be applied even if you increase the Shuffle Rate setting.

Accent Rate

This is the setting page for "Adding Expression to the Arpeggio (Accent Rate)" (p. 106).

Octave Range

This is the setting page for "Changing the Pitch Range of the Arpeggio (Octave Range)" (p. 106).

Saving Arpeggio Settings That You Have Modified (Arpeggio Write)

When you have created a playback pattern that you like, save the settings as a User Style. The MC-505 has ten user styles, USER STYLE 1-10, and user styles that you save can be recalled at any time.

1. Create the arpeggio playback pattern.
2. Make sure that the setting page for the **ARPEGGIO** section is displayed.

If not, hold down [SHIFT] and press keyboard pad [1] to access the setting page.

3. Press [WRITE].

The following display will appear.



4. Use [INC] [DEC] or the [VALUE] dial to specify the writing destination user style.

Range: USER STYLE 1-10

5. Press [ENTER].

The execute page will appear in the display.

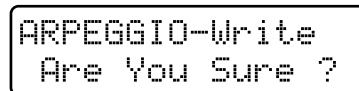

6. Press [ENTER] once again.

The Arpeggio Write operation will be executed, and the normal display will reappear.

To cancel the operation without executing, press [EXIT].

RPS (Real-Time Phrase Sequence) is a function which lets you play back the musical data of a specific part of a pattern simply by pressing one of the keyboard pads. You can play different phrases simply by pressing different notes. Since you can play back RPS phrases while a pattern is playing, this function is especially convenient during a live performance. For example, if a drum fill-in phrase used by one pattern is assigned as an RPS, you can play back another pattern without a fill-in, and then add the fill-in simply by pressing a keyboard pad.

Using the Keyboard Pads to Play Back Phrases

On the MC-505, phrases assigned to each of the 16 keyboard pads are handled as one "RPS Set." You are free to re-assign the contents of an RPS set, and 60 sets can be stored. You can switch RPS sets even while a pattern is playing back.

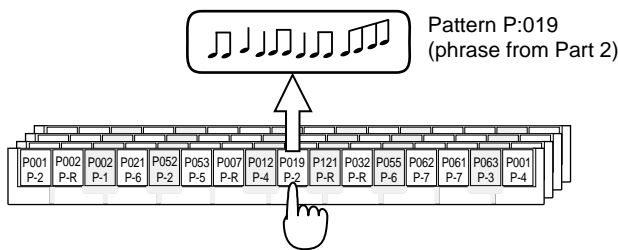

1. In the DISPLAY section, press [RPS SET].

The indicator will light, and the display will indicate the bank, number and name of the currently selected RPS set.

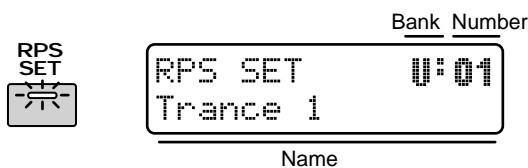

2. Press [USER].

[USER] U: (User Bank)

* For RPS sets it is not possible to select preset or card banks.

3. Use [INC] [DEC] or the [VALUE] dial to select the number.

Range: U:01–U:60

The selection in the display will change. The RPS set is now selected.

* A brief interval of time is needed for the RPS set to change. Also, if you change RPS sets during pattern playback, the pattern may slow down or falter, so it is best to change RPS sets while pattern playback is stopped.

4. Press [RPS] to make the button indicator light.

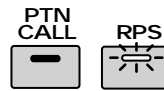

5. Press a keyboard pad to play back a phrase.

The phrase will play back while you continue pressing the keyboard pad.

RPS Hold

If while playing back RPS you press [HOLD] to make the indicator light, you can cause the RPS to continue playing even after you take your finger off the keyboard pad. An RPS which is pressed after [HOLD] is lit will stop when you release your finger from the keyboard pad.

If you connect a pedal switch (optional: DP-2, DP-6, FS-5U etc.) and set the System parameter "Pedal Assign" to "HOLD," the pedal switch can be used in the same way to hold the RPS.

☞ "Specifying How the Pedal Will Function" (p. 165)

RPS Modify

While you are pressing a keyboard pad to play an RPS, you can move the Patch parameter knobs to modify the sound of the RPS. If you are pressing two or more keyboard pads, You can modify the sound of the pad that was last pressed.

RPS playback timing

If you use RPS while a pattern is playing back, the phrase will start in synchronization with the beat of the pattern.

By changing the RPS Trigger Quantize setting, you can modify the timing at which the RPS will play back.

☞ "Specifying the Timing for RPS Playback (RPS Trigger Quantize)" (p. 167)

- RPS can also be played from an external MIDI keyboard, as well as from the keyboard pads.

☞ "Using an External MIDI keyboard to Play RPS or Arpeggios" (p. 172)

Maximum simultaneous RPS playback

Even while a pattern is playing back, the MC-505 can play back up to 8 phrases simultaneously. However, if phrases with large amounts of data are played back simultaneously, the timing may lag behind or notes may be interrupted. If this occurs, decrease the number of phrases that you play simultaneously.

Assigning a Phrase to a Keyboard Pad

The phrases that are assigned to an RPS set can be re-assigned whenever you wish. You will find it convenient to assign your favorite or frequently-used phrases in one RPS set. As an example, here's how to assign the phrase of part 2 of P:002 in an RPS set. First we must select the RPS set in which we will assign the phrase.

1. Select the RPS set to which you wish to assign the phrase.
2. Select pattern P:002.
3. Use [PART MUTE] and the PART buttons to mute all parts except for part 2.

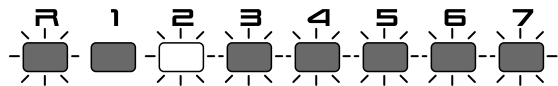

4. Make sure that the [RPS] indicator is lit.
5. Hold down [RPS], and press the keyboard pad to which you wish to assign the phrase.

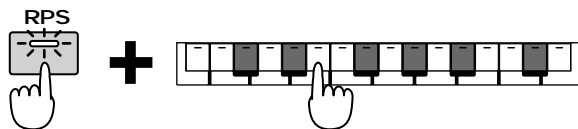

The phrase will be assigned to the keyboard pad that you pressed. Phrases can be assigned even while a pattern is playing back.

P:249–P:714 contain patterns which are prepared specifically for use with RPS. You might find it convenient to assign phrases from these patterns to use as fill-ins, or for other situations.

Cautions when assigning an RPS

* It is not possible to assign phrases of two or more parts to a single keyboard pad. You must mute all but one of the parts, the one with the desired phrase, before assigning it. If any of the extra parts have been left unmuted when you make your assignment, the following message will appear in the display:

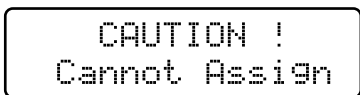

- * If after assigning a phrase from a user pattern as an RPS, you then modify the playback data of the pattern which contains that phrase, be aware that any change to the phrase will also be reflected in the way it is played back by RPS. For example, if you delete the musical data of the pattern which contains the phrase that you assigned, there will be no sound when you attempt to play back that phrase by RPS.
- * Even if you assign the phrase of a part that has a setting of "EXT" for its Sequencer Output Assign (p. 25) parameter, the musical data of that phrase will not be transmitted from MIDI OUT.
- * If you assign a phrase from a part that uses EFX, the RPS playback will use the EFX settings of the pattern that is selected at that time. This means that what you hear when the RPS plays back may be somewhat different from the original phrase.
- * If a rhythm part phrase is assigned, the Rhythm Mute settings will be ignored during RPS playback.
- * Each phrase is played back by a special RPS part 1–16 which corresponds to each keyboard pad, but phrases assigned from a rhythm part will be played back using the rhythm part of the currently-selected pattern. For this reason, a different rhythm set than that of the registered pattern may sound in some cases. If the pattern changes so that a different rhythm set is selected, the sounds of the rhythm set which will play the RPS will also change.

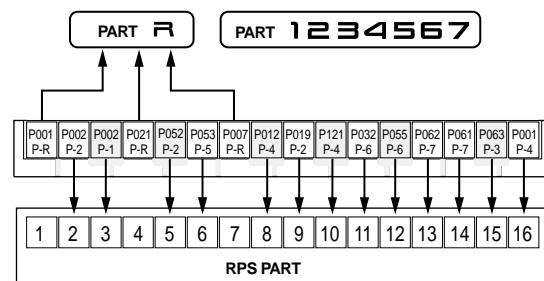

Checking the pattern number and part that were registered.

If you hold down a keyboard pad to which an RPS was registered and press [PTN/SONG], the pattern number, name and the part registered to that pad will appear in the display while you continue pressing the pad.

Making Settings for Each Phrase

Using the Part Mixer to Modify Settings

You can use the part mixer to modify settings such as volume and pan for each RPS part.

The following parameters can be modified for each RPS part.

- RPS Lvl (RPS Part Level)
- RPS Pan (RPS Part Pan)
- RPS Key (RPS Part Key Shift)
- RPS Rev (RPS Part Reverb Level)
- RPS Dly (RPS Part Delay Level)
- RPS EFX (RPS EFX Output Assign)

1. Make sure that the [RPS] indicator is lit.
2. Hold down [RPS] and Press [TEMPO/MIXER]. The indicator will light, and the display will graphically show the current setting of each RPS part.
3. Press [MIXER SELECT] several times to select the parameter that you wish to modify. The indicator of the selected parameter will blink.

* MEGAMIX cannot be selected.

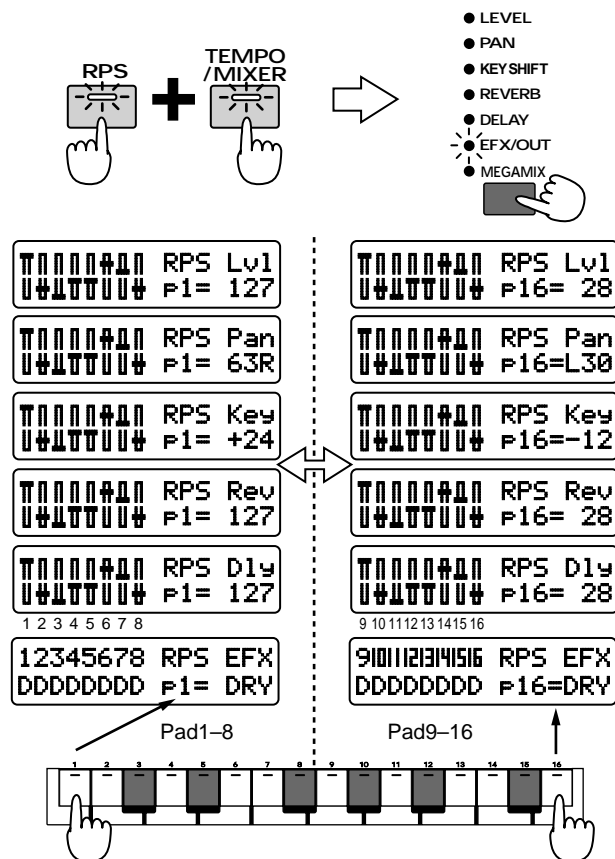

4. Press the keyboard pad to switch the parts that are shown in the display.

Pressing any keyboard pad [1]–[8] will cause the settings for RPS parts [1]–[8] to be graphically displayed. Pressing any keyboard pad [9]–[16] will cause the settings for RPS parts [9]–[16] to be graphically displayed.

The right side of the display will show the current setting of the RPS part for the keyboard pad that you pressed.

5. Use part sliders [R]Ø[7] to modify the setting for each RPS part.

* Keyboard pads to which a rhythm part phrase is assigned will reflect the rhythm part settings of the currently selected pattern. For example, if RPS phrases using the rhythm part are assigned to keyboard pads [1] and [2], modifying the volume setting or rhythm set of keyboard pad [1] will cause the settings of keyboard pad [2] and the rhythm part of the selected pattern to change in the same way.

Changing the Patch of Each RPS Part

You can change the sound which plays each RPS part, so that the phrase assigned to each keyboard pad will be heard with a different sound.

1. Hold down [RPS] and press [PATCH]. The following display will appear.

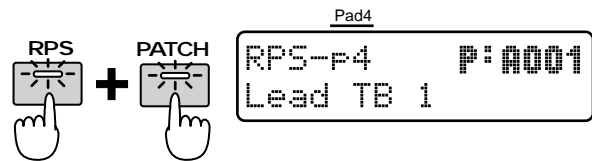

2. Press a keyboard pad to select the RPS part with the patch you wish to change. The display will indicate the patch of the selected RPS part.
3. Use the BANK buttons and [INC] [DEC] or the [VALUE] dial to select the desired patch.

* If you change the rhythm set of a keyboard pad to which a rhythm part phrase is registered, the rhythm set of the currently selected pattern will change in the same way.

Saving the Phrases You Assigned (RPS Set Write)

When you have assigned phrases to create an RPS set that you like, here's how to save it as a User RPS Set.

1. Make sure that the pattern is stopped.
2. Press [RPS SET] to access the RPS Set Select page.

When you modify the contents of an RPS set, an asterisk "*" will appear at the left of the number, indicating that the selected RPS set has been modified (edited). Be aware that if you turn off the power without saving the modified RPS set, the previous settings will reappear.

3. Press [WRITE].

The following display will appear, and a cursor "_" will appear below the number.



6. If you do not wish to change the number or name, you may skip steps 4–8. If you decide not to save the pattern, press [EXIT].

4. Select the save destination bank. When saving an RPS set, only the user bank can be selected.
5. Use [INC] [DEC] or the [VALUE] dial to select the save destination number.

.....
 At this time, you can press [UNDO/REDO] to check the name of the RPS set that is currently in the save destination number. After you have found an RPS set that you do not mind overwriting, press [UNDO/REDO] once again to return to the previous display.

6. Press PAGE [>]. The cursor will move to the beginning of the second line of the display.

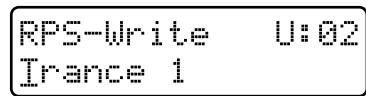

7. Assign a name to the RPS set. Use [INC] [DEC] or the [VALUE] dial to specify the characters. The following characters can be selected. space, A-Z, a-z, 0-9, ! " # \$ % & ' () * + , - . / : ; < = > ?

@ [¥] ^ _ ` { | }

8. Repeat steps 6D7 to input the name. By pressing PAGE [<] you can move the cursor back counterclockwise.

9. Press [ENTER]. The execute display will appear. If you wish to cancel the operation, press [EXIT].

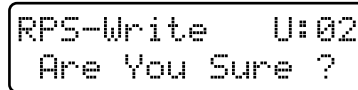

10. Press [ENTER] once again.

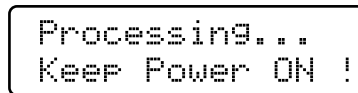

The RPS Set Write operation will be executed, and the normal display will reappear. The RPS set has now been saved.

Chapter 7. Changing the Groove of a Pattern (Play Quantize)

Play Quantize is a function which modifies the pattern that is being played back by correcting or skewing the timing of the notes according to a specified rule. This means that you can modify only the timing with which the pattern will play back, without affecting the contents of the data itself.

The MC-505 provides three types of quantization, which you can use as appropriate for your situation. You can apply Play Quantize to a specified part while a pattern plays back, and make detailed timing adjustments in real time while you listen to the playback.

* Quantization affects only the timing of the note messages (the timing at which notes are played and released), and does not modify the timing of other messages. This means that if a pattern contains messages (such as pitch bend) that apply real-time change to the sound, quantization settings may cause the timing of these messages to no longer match the timing of the note messages, so that playback will be incorrect. When applying quantization, it is best to use a pattern which does not contain messages that apply real-time change to the sound.

Selecting Parts to Use with Play Quantize

Play Quantize can be applied to the playback of a specific part. Before you apply Play Quantize, you must specify the part(s) to which it will apply.

1. Hold down [SHIFT] and press [QTZ SELECT].

The button indicator will blink.

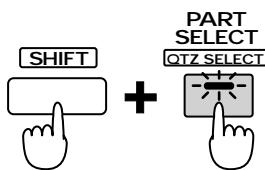

2. Make the PART button light for the part to which you wish to apply Play Quantize. Play Quantize will be applied to the parts which are lit.

The indicator of the button you pressed will light.

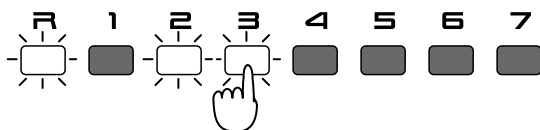

Correcting Inaccuracies in the Rhythm (Grid Quantize)

Grid Quantize will quantize the pattern playback timing to the nearest specified note value. This will cause the pattern to play back with accurate timing.

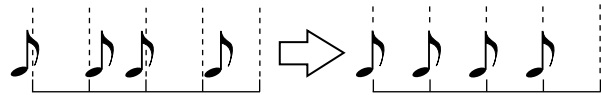

* When Grid Quantize is used, the playback timing will be correct, but conversely this may produce a mechanical, inhuman feel. If you wish to preserve the feel of the performance, you can set Resolution to a fine value, or lower the Strength setting.

Specifying the Unit (Resolution)

The note value unit to which quantization will adjust the timing is called the Resolution. The timing of notes will be adjusted to the nearest grid interval of the note value you specify here. Set this to the length of the smallest note value that occurs in the pattern.

1. Hold down [SHIFT] and press keyboard pad [2].

The Grid Quantize setting page will appear.

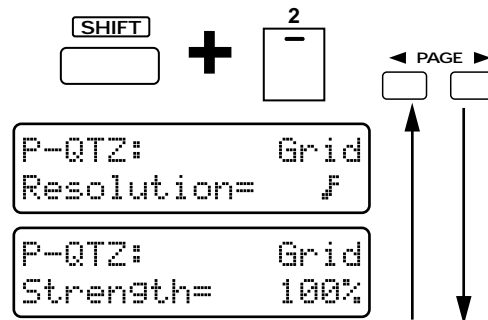

2. Use [INC] [DEC] or the [VALUE] dial to set the Resolution.

Range: ♩ ♪ ♫ ♬ ♭ ♭♭ ♯

To exit the setting page, press [EXIT].

.....
When the GRID indicator is lit, you can also hold down [QUANTIZE] and rotate the [VALUE] dial to modify the Resolution.
.....

Applying Grid Quantize

1. Play back the pattern that you wish to quantize.
2. Press [QUANTIZE] several times to make the GRID indicator light.

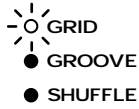

3. Grid Quantize will be applied to the playback data according to the Resolution setting.
4. Rotate the [TIMING] knob to adjust the Strength.
Range: 0–100%

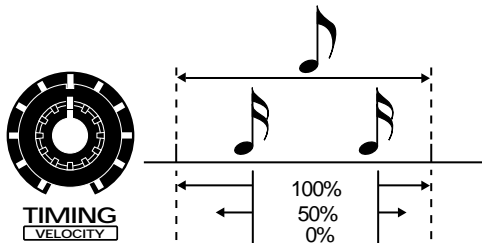

Strength specifies the degree to which the note timing will be corrected toward the note value specified by Resolution. Rotating the knob clockwise will cause the notes to be corrected all the way to their correct timing. When this setting is at “0%,” the notes will be played at their original (un-quantized) timing.

In the Grid Quantize setting page, you can use PAGE [<] [>] to access the Strength setting page and view the numerical value of the knob setting while you apply quantization.

Giving Swing to the Rhythm (Shuffle Quantize)

By applying Shuffle Quantize, you can adjust the timing of the backbeats of the pattern to create “bouncy” rhythms such as shuffle or swing.

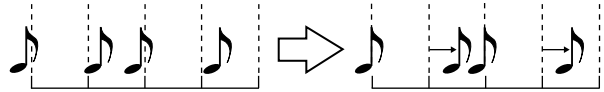

Specifying the Unit (Resolution)

Specifies the Resolution. The timing of notes will be adjusted to the nearest grid interval of the note value you specify here. Set this to the length of the smallest note value that occurs in the pattern.

1. Hold down [SHIFT] and press keyboard pad [4].

The Shuffle Quantize setting page will appear.

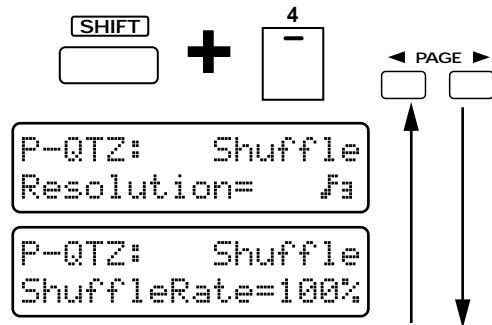

2. Use [INC] [DEC] or the [VALUE] dial to specify the Resolution.

Range: ♪ ♪

To exit the setting page, press [EXIT].

When the SHUFFLE indicator is lit, you can also hold down [QUANTIZE] and rotate the [VALUE] dial to modify the Resolution.

7

Applying Shuffle Quantize

1. Play back the pattern that you wish to quantize.

2. Press [QUANTIZE] several times to make the SHUFFLE indicator light.



3. Shuffle Quantize will be applied according to the Resolution setting.

4. Rotate the [TIMING] knob to adjust the Shuffle Rate.

Range: 0–100 %

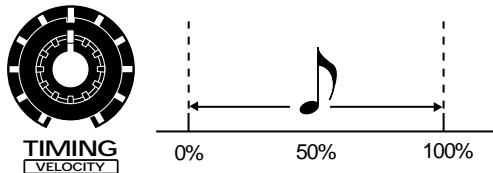

Shuffle Rate refers to the degree to which the backbeats will bounce, and specifies the ratio by which the backbeats will be separated from the downbeats. When the knob is in the center position, this setting is at 50%, and the backbeats will be located exactly between the adjacent downbeats.

Rotating the knob clockwise will move the backbeats later in time. Rotating the knob counterclockwise will move the backbeats earlier in time.

100%: Backbeats will fall at the same timing as the following downbeat.

0%: Backbeats will fall at the same timing as the preceding downbeat.

.....
In the Shuffle Quantize setting page, you can use PAGE [<] [>] to access the Shuffle Rate setting page, and apply quantization while viewing the numerical setting of the knob.
.....

Giving a Groove to the Rhythm (Groove Quantize)

Groove Quantize lets you select a template by which the playback timing and the velocity will be quantized. Simply by selecting a different template, you can give a variety of different-feeling grooves to a pattern. The MC-505 contains 71 different types of quantization templates, each of which contains a different set of playback timing and velocity (dynamics) data.

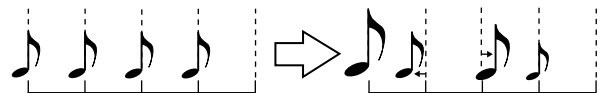

* The templates are for use with 4/4 time signatures. They will not produce the desired result when applied to other time signatures.

Selecting the Template

1. Hold down [SHIFT] and press keyboard pad [3].

The Groove Quantize setting page will appear in the display.

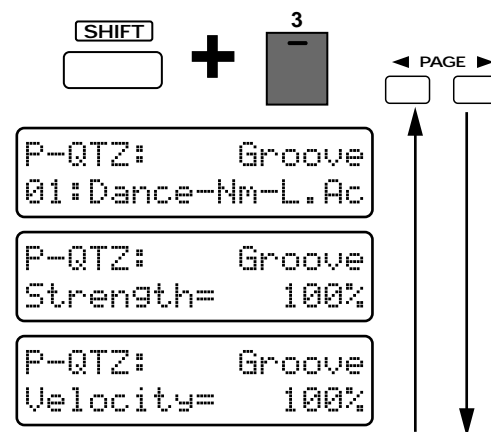

2. Use [INC] [DEC] or the [VALUE] dial to select the template.

To exit the setting page, press [EXIT].

Available Settings:

16 Beat Dance type

01: Dance-Nm-L.Ac	exact/low dynamics
02: Dance-Nm-H.Ac	exact/high dynamics
03: Dance-Nm-L.Sw	exact/light swing
04: Dance-Nm-H.Sw	exact/strong swing
05: Dance-Hv-L.Ac	dragging/low dynamics
06: Dance-Hv-H.Ac	dragging/high dynamics
07: Dance-Hv-L.Sw	dragging/light swing
08: Dance-Hv-H.Sw	dragging/strong swing
09: Dance-Ps-L.Ac	rushing/low dynamics
10: Dance-Ps-H.Ac	rushing/high dynamics
11: Dance-Ps-L.Sw	rushing/light swing
12: Dance-Ps-H.Sw	rushing/strong swing

16 Beat Fusion type

13: Fuson-Nm-L.Ac	exact/low dynamics
14: Fuson-Nm-H.Ac	exact/high dynamics
15: Fuson-Nm-L.Sw	exact/light swing
16: Fuson-Nm-H.Sw	exact/strong swing
17: Fuson-Hv-L.Ac	dragging/low dynamics
18: Fuson-Hv-H.Ac	dragging/high dynamics
19: Fuson-Hv-L.Sw	dragging/light swing
20: Fuson-Hv-H.Sw	dragging/strong swing
21: Fuson-Ps-L.Ac	rushing/low dynamics
22: Fuson-Ps-H.Ac	rushing/high dynamics
23: Fuson-Ps-L.Sw	rushing/light swing
24: Fuson-Ps-H.Sw	rushing/strong swing

16 Beat Reggae type

25: Regge-Nm-L.Ac	exact/low dynamics
26: Regge-Nm-H.Ac	exact/high dynamics
27: Regge-Nm-L.Sw	exact/light swing
28: Regge-Nm-H.Sw	exact/strong swing
29: Regge-Hv-L.Ac	dragging/low dynamics
30: Regge-Hv-H.Ac	dragging/high dynamics
31: Regge-Hv-L.Sw	dragging/light swing
32: Regge-Hv-H.Sw	dragging/strong swing
33: Regge-Ps-L.Ac	rushing/low dynamics
34: Regge-Ps-H.Ac	rushing/high dynamics
35: Regge-Ps-L.Sw	rushing/light swing
36: Regge-Ps-H.Sw	rushing/strong swing

8 Beat Pops type

37: Pops-Nm-L.Ac	exact/low dynamics
38: Pops-Nm-H.Ac	exact/high dynamics
39: Pops-Nm-L.Sw	exact/light swing
40: Pops-Nm-H.Sw	exact/strong swing
41: Pops-Hv-L.Ac	dragging/low dynamics
42: Pops-Hv-H.Ac	dragging/high dynamics
43: Pops-Hv-L.Sw	dragging/light swing
44: Pops-Hv-H.Sw	dragging/strong swing
45: Pops-Ps-L.Ac	rushing/low dynamics
46: Pops-Ps-H.Ac	rushing/high dynamics
47: Pops-Ps-L.Sw	rushing/light swing
48: Pops-Ps-H.Sw	rushing/strong swing

8 Beat Rhumba type

49: Rhumb-Nm-L.Ac	exact/low dynamics
50: Rhumb-Nm-H.Ac	exact/high dynamics
51: Rhumb-Nm-L.Sw	exact/light swing
52: Rhumb-Nm-H.Sw	exact/strong swing
53: Rhumb-Hv-L.Ac	dragging/low dynamics
54: Rhumb-Hv-H.Ac	dragging/high dynamics
55: Rhumb-Hv-L.Sw	dragging/light swing
56: Rhumb-Hv-H.Sw	dragging/strong swing
57: Rhumb-Ps-L.Ac	rushing/low dynamics
58: Rhumb-Ps-H.Ac	rushing/high dynamics
59: Rhumb-Ps-L.Sw	rushing/light swing
60: Rhumb-Ps-H.Sw	rushing/strong swing

Others

61: Samba 1	samba (pandero)
62: Samba 2	samba (surdo and timba)
63: Axe 1	axe (caixa)
64: Axe 2	axe (surdo)
65: Salsa 1	salsa (cascara)
66: Salsa 2	salsa (conga)
67: Triplets	triplets
68: Quintuplets	quintuplets
69: Sextuplets	sextuplets
70: 7 against 2	seven notes played over two beats
71: Lagging Tri	lagging triplets

7

Selecting a template

Templates are categorized by the three elements of genre, groove, and variation.
 Select the template which combines the desired elements.

Genre

- Dance: 16 beat dance
- Fusion: 16 beat fusion
- Reggae: 16 beat reggae
- Pops: 8 beat pops
- Rhumb: 8 beat rhumba
- Others: samba, axe, salsa, triplets

Groove

- Nm (Normal): on the beat
- Hv (Heavy): "dragging" the beat
- Ps (Pushed): "rushing" the beat

Variation

- L.Ac (Light Accent): light dynamics
- H.Ac (Hard Accent): heavy dynamics
- L.Sw (Light Swing): light swing
- H.Sw (Hard Swing): strong swing

For example, in the case of a dance song where you wish to drag the beat with light swing, you would select "Dance-Hv-L.Sw."

- * The genre names are only a guideline, and do not mean that those templates can be used only in the named genre. Try out additional possibilities.
- * If you apply Groove Quantize to musical data which contains inaccuracies in timing, you may not obtain the desired results. In such cases, it is best to apply Grid Quantize first, to bring the timing of the original musical data into alignment with the printed notes.
- * The templates are for use with 4/4 time signatures. Applying them to other time signatures may not produce the desired result.
- * For samba, axe, salsa and triplet, it is not possible to select groove or variation.

When the GROOVE indicator is lit, you can hold down [QUANTIZE] and rotate the [VALUE] dial to change the template.

Applying Groove Quantize

1. Play back the pattern that you wish to quantize.
2. Press [QUANTIZE] to make the GROOVE indicator light.



3. Groove Quantize will be applied according to the settings of the selected template.
4. Rotate the [TIMING] knob to adjust the Strength.

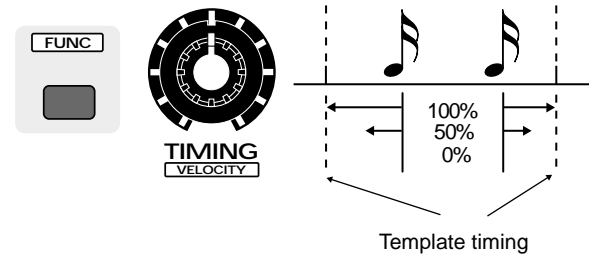

Range: 0–100%

Strength specifies the degree to which the note timing will be corrected toward the timings specified by the template. As the knob is rotated clockwise, the notes will be corrected further toward the timing of the template.

When this setting is at "0%," the notes will be played at their original (un-quantized) timing.

5. Press [FUNC] to make the indicator blink, and rotate the VELOCITY knob to adjust the Velocity Strength.

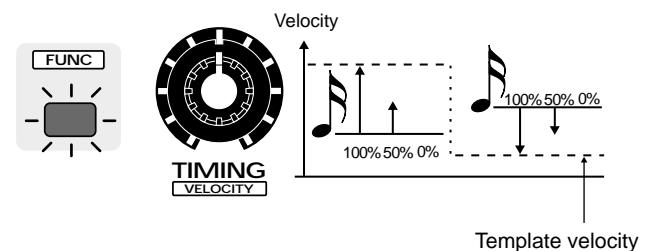

Range: 0–100%

Velocity Strength is the degree to which the velocities of the pattern will be adjusted toward the velocities of the template. As the knob is rotated clockwise, the velocities that are played will be closer to the velocities of the template.

When this setting is at "0%," the notes will be played at their original velocities.

.....
In the Groove Quantize setting page, you can also use PAGE [<] [>] to access the Strength or Velocity Strength setting pages, and use the knobs to adjust the setting while you view the numerical setting of the parameter.
.....

Techniques for creating a sense of groove

Templates use a variety of means to produce an optimal performance result for Groove Quantize. Refer to the following points as you use templates.

Apply Groove Quantize to drums and bass lines

The drums and bass are the most important parts in creating the groove. Thus, the templates are created to match these instruments. It is best to apply Groove Quantize only to instruments which need it.

Adjust the tempo

The groove templates have been created based on a tempo in the range of $q=120-140$. When applying Groove Quantize to a song with a faster tempo than this, set Strength to 100% for maximum effectiveness. For a song with a slower tempo than this, set Strength below 100%.

7

To create an effective swing

Careful attention to the tempo is an important part of creating an effective swing. For example, in the case of jazz, it will be effective to apply deeper swing to songs that have a slow tempo. Conversely, lightening the swing for a faster tempo will give a greater sense of speed. In another example, applying deeper swing to a dance-type rhythm at a rapid tempo will produce a feeling of "bounce."

Try out various settings to find the most effective type of swing.
.....

Megamix is a function which lets you play back a pattern while you exchange the musical data of one part with the data from a different pattern. You can combine phrases for each instrument to create a completely different pattern, just as if you were creating a remix.

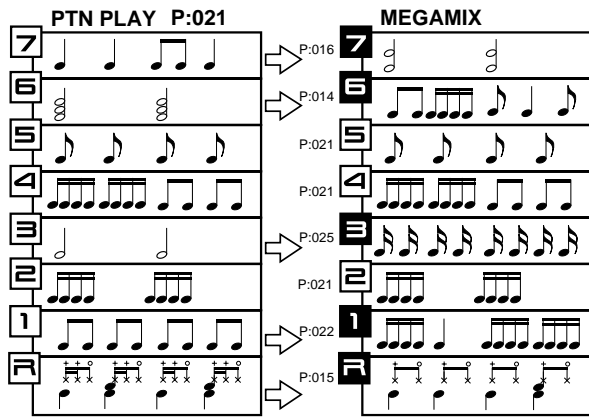

* This diagram is intended to explain the concept of MEGAMIX. It does not imply that phrases of actual patterns are as shown in the diagram.

Exchanging Phrases

1. Select and play back a pattern.

2. Press [TEMPO/MIXER].

The indicator will light, and the mixer page will appear.

3. Press [MIXER SELECT] several times to make the MEGAMIX indicator light.

You will enter Megamix mode.

The left side of the display will indicate the pattern select status of each part as a bar.

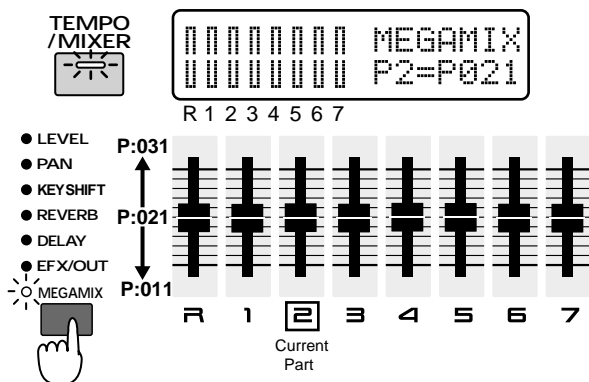

4. Use part sliders [R]Ø[7] to select the pattern for each part.

The right side of the display will show the pattern number which you selected by moving the slider.

The slider can be used to select from the ten patterns

before or after the pattern number of the current part. For example, if the pattern of the current part is "P:021," raising the slider all the way up would select "P:031," and lowering the slider all the way down would select "P:011."

The graphic will also change as you move the slider. The slider graphic will be displayed with the pattern of the current part as the axis.

When you change the current part, the pattern which is the axis will also change, and the pattern numbers that can be selected by each slider will also change.

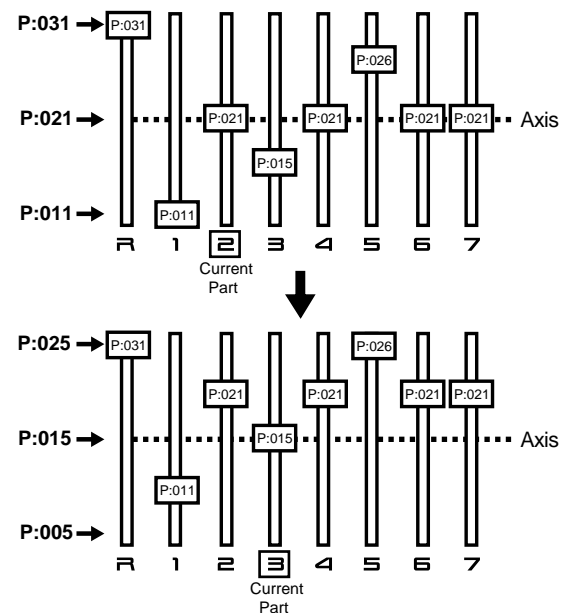

In the example of this diagram, changing the current part from part 2 to part 3 has caused the variable range of the slider to change from P:011–P:031 to P:005–P:025. The patterns of the rhythm part and of part 5 are now outside of the variable range, but these pattern numbers will be maintained unless you move the slider.

5. The pattern which was exchanged for each part will be selected when the pattern repeats.

To exit MEGAMIX mode, press [MIXER SELECT] to make the MEGAMIX indicator go dark.

* Even after you exit MEGAMIX mode, the exchanged settings will be maintained until you select a different pattern. It is not possible to record a pattern while the pattern is exchanged.

* The time signature and number of measures of the patterns played back by MEGAMIX will depend on the time signature and number of measures of the rhythm part pattern. Also, the mute status of each part will be maintained in MEGAMIX.

* If the exchanged pattern contains no playback data, there will be no playback. In the case of the preset patterns, none of the patterns contain playback data for part 1. Also, keep in mind that the other parts will not necessarily contain playback data.

Selecting a Distant Pattern

If you wish to select a pattern at a distant number without being restricted by the variable range of the slider, use the following procedure.

1. Select the part for which you wish to select a distant pattern as the current part.
2. Press [PTN/SONG] to access the pattern select page.

During MEGAMIX, the following display will appear. The pattern number and name of the current part will be displayed.

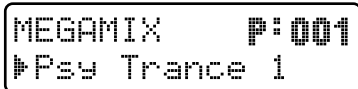

3. Use [INC] [DEC] or the [VALUE] dial to select the pattern.

By changing the current part, you can select patterns for other parts in the same way. When you press [TEMPO/MIXER] to return to the mixer page, the pattern of the current part (axis) will change, and the patterns of other parts will all be outside of the variable range of the slider, meaning that one or the other of the states shown in the following diagram will apply.

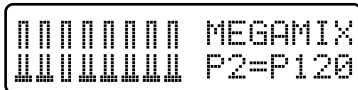

8

Saving the Exchanged Pattern

When you have used MEGAMIX to create a pattern that you like, you can save it as a User Pattern. The saved pattern can be recalled during normal pattern playback, just as any other pattern.

1. Use MEGAMIX to create a pattern.
2. Press [MIXER SELECT] to make the MEGAMIX indicator go dark, exiting MEGAMIX mode.
3. Press [STOP] to stop pattern playback.
4. Now you can perform the Pattern Write operation to save the pattern as a User Pattern (p. 26).

* It is not possible to record a pattern while in MEGAMIX mode.

Tips when using MEGAMIX to create a pattern

If the patterns that you combine using MEGAMIX have different time signatures or a different number of measures, their playback may not be connected appropriately. When using MEGAMIX to combine patterns, it is best to combine patterns of the same number of measures and time signature.

When you use MEGAMIX to exchange patterns, the volume balance between parts may change significantly, depending on the phrases being exchanged. In such cases, use the part mixer to readjust the part level before saving the pattern. Of course, you can also modify the pan and key shift settings etc. in the same way.

In many preset patterns, the various parts are organized as follows.

- Rhythm part:** drums
- Part 1:** for manual playing (contains no playback data)
 - Part 2:** bass
 - Part 3:** chord 1
 - Part 4:** lead 1
 - Part 5:** chord 2
 - Part 6:** lead 2
 - Part 7:** other

You can refer to this when you exchange the playback data of a part. For example, you can exchange part 2 if you want to exchange the bass, or part 4 or 6 if you want to exchange the lead.

If you follow the above guidelines when creating user patterns as well, it will be easier to use your patterns with MEGAMIX.

Chapter 9. Using the DBeam Controller to Apply Various Effects

The DBeam Controller is a new type of controller that is operated by simply passing your hand over it. Twenty-eight different types of control, such as “Turntable” and “Ad-lib” are provided. By changing the control type, you can apply various effects to the sound generator and sequencer. In addition to being used as an individual controller, it can also be used to do things that would be impossible for a knob or slider, such as controlling multiple knobs or sliders simultaneously, or changing the sound instantly.

* The DBeam has been licensed from Interactive Light, Inc.

Using the DBeam Controller

1. Press D BEAM CONTROLLER [ON].

The indicator will light, and the DBeam Controller will be turned on.

2. Press [TYPE SELECT] to select the Type.

At the factory settings, you can select one of the following three types: TURNTABLE (24:Turntable), CUT+RESO (07:Cut+Reso2-A) or ADLIB (27:Adlib1).

By rotating the [VALUE] dial while you press D BEAM CONTROLLER [ON], you can select from all types.

While this button is held down, the display will show the name of the currently selected type.

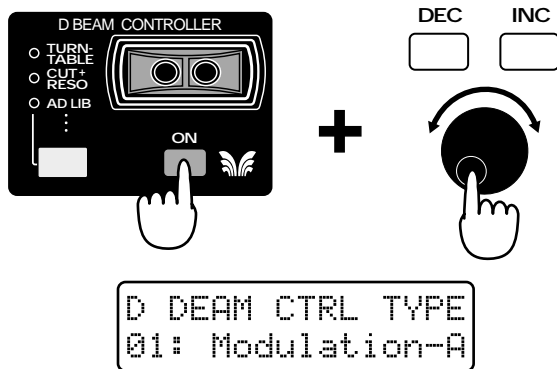

3. Operate the controller by passing your hand over the DBeam Controller.

Depending on the type, the effect will be applied differently for different positions of your hand.

4. To turn off the DBeam Controller, press D BEAM CONTROLLER [ON] once again to make the indicator go dark.

The effective range of the DBeam Controller

The effective range of the DBeam Controller is as shown in the following diagram. Hand movement outside of this area will have no effect.

* The effective range of the DBeam controller will decrease in locations of strong direct sunlight. Be aware of this when using the DBeam controller outdoors.

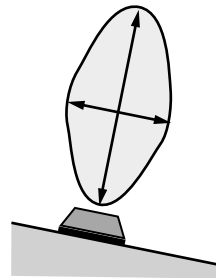

Changing the button assignments

By changing the Beam Assign 1–3 System settings, you can freely modify the types that will be selected by [TYPE SELECT].

☞ “Specifying How the DBeam Controller Will Function” (p. 165)

Changing the polarity of the change

By changing the Beam Polarity System setting, you can invert the direction of the effect that is applied.

In this manual, the explanation for each type will assume that the Beam Polarity is set to “STANDARD.”

☞ “Specifying How the DBeam Controller Will Function” (p.165)

How Each Type Will Function

01:Modulation-A (Modulation All)

The DBeam Controller will have the same function as the modulation lever of an external MIDI keyboard. Hand movement will apply modulation to all parts.

As your hand comes closer to the controller, the effect will be deeper.

If your hand is outside of the effective range, the effect will be “0” regardless of the location of your hand.

* The effect that is applied when the modulation lever is operated will depend on the patch.

☞ “Specifying the Parameters That Will Be Modified by Each Controller (Control)” (p. 59)

02:Modulation-S (Modulation Single)

The DBeam Controller will have the same function as the modulation lever of an external MIDI keyboard. Hand movement will apply modulation to the current part.

As your hand comes closer to the controller, the effect will be deeper.

If your hand is outside of the effective range, the effect will be “0” regardless of the location of your hand.

* The effect that is applied when the modulation lever is operated will depend on the patch.

 **“Specifying the Parameters That Will Be Modified by Each Controller (Control)” (p. 59)**

03:Pitch Bend-A (Pitch Bend All)

The DBeam Controller will have the same function as the pitch bend lever of an external MIDI keyboard. Hand movement will apply pitch bend to all parts.

As your hand comes closer to the controller, the pitch will rise.

If your hand is outside of the effective range, the effect will be “0” regardless of the location of your hand.

* The effect that is applied when the pitch bend lever is operated will depend on the patch.

 **“Specifying the Parameters That Will Be Modified by Each Controller (Control)” (p. 59)**

9

04:Pitch Bend-S (Pitch Bend Single)

The DBeam Controller will have the same function as the pitch bend lever of an external MIDI keyboard. Hand movement will apply pitch bend to the current part.

As your hand comes closer to the controller, the pitch will rise.

If your hand is outside of the effective range, the effect will be “0” regardless of the location of your hand.

* The effect that is applied when the pitch bend lever is operated will depend on the patch.

 **“Specifying the Parameters That Will Be Modified by Each Controller (Control)” (p. 59)**

.....
When you select a type 05–10, be careful not to raise Low Boost excessively, since the sound will be prone to cracking or distorting. It is also best to turn [OCTAVE] off.
.....

05:Cut+Reso1-A (Cutoff + Resonance 1 All)

Hand movement will modify the cutoff and resonance of all parts.

As your hand comes closer to the controller, the cutoff and resonance values will increase.

If your hand is outside of the effective range, the cutoff and resonance values will be “0” regardless of the location of your hand.

* If you wish to restore the pattern to its original state, use [INC] [DEC] or the [VALUE] dial to re-select the same pattern. The next time that the pattern repeats, it will return to its original settings.

* The resonance value will not increase beyond the value specified by the Resonance Limiter.

 **“Specifying the Variable Range of Resonance (Resonance Limiter)” (p. 164)**

06:Cut+Reso1-S (Cutoff + Resonance 1 Single)

Hand movement will modify the cutoff and resonance of the current part.

As your hand comes closer to the controller, the cutoff and resonance values will increase.

If your hand is outside of the effective range, the cutoff and resonance values will be “0” regardless of the location of your hand.

* If you wish to restore the pattern to its original state, use [INC] [DEC] or the [VALUE] dial to re-select the same pattern. The next time that the pattern repeats, it will return to its original settings.

* The resonance value will not increase beyond the value specified by the Resonance Limiter.

 **“Specifying the Variable Range of Resonance (Resonance Limiter)” (p. 164)**

07:Cut+Reso2-A (Cutoff + Resonance 2 All)

Hand movement will modify the cutoff and resonance of all parts.

As your hand comes closer to the controller, the cutoff value will decrease, and the resonance value will increase.

If your hand is outside of the effective range, the cutoff value will be “127” and the resonance value will be “0,” regardless of the location of your hand.

* If you wish to restore the pattern to its original state, use [INC] [DEC] or the [VALUE] dial to re-select the same pattern. The next time that the pattern repeats, it will return to its original settings.

* The resonance value will not increase beyond the value specified by the Resonance Limiter.

 "Specifying the Variable Range of Resonance (Resonance Limiter)" (p. 164)

08:Cut+Reso2-S (Cutoff + Resonance 2 Single)

Hand movement will modify the cutoff and resonance of the current part.

As your hand comes closer to the controller, the cutoff value will decrease, and the resonance value will increase.

If your hand is outside of the effective range, the cutoff value will be "127" and the resonance value will be "0," regardless of the location of your hand.

* If you wish to restore the pattern to its original state, use [INC] [DEC] or the [VALUE] dial to re-select the same pattern. The next time that the pattern repeats, it will return to its original settings.

* The resonance value will not increase beyond the value specified by the Resonance Limiter.

 "Specifying the Variable Range of Resonance (Resonance Limiter)" (p. 164)

09:Cut+Reso3-A (Cutoff + Resonance 3 All)

Hand movement will modify the cutoff and resonance of all parts.

The moment that your hand is placed over the controller, the resonance will reach the maximum value, and as your hand comes closer to the controller, the cutoff value will increase.

If your hand leaves the effective range, the cutoff value will be "127" regardless of the location of your hand.

* If you wish to restore the pattern to its original state, use [INC] [DEC] or the [VALUE] dial to re-select the same pattern. The next time that the pattern repeats, it will return to its original settings.

* The resonance value will not increase beyond the value specified by the Resonance Limiter.

 "Specifying the Variable Range of Resonance (Resonance Limiter)" (p. 164)

10:Cut+Reso3-S (Cutoff + Resonance 3 Single)

Hand movement will modify the cutoff and resonance of the current part.

The moment that your hand is placed over the controller, the resonance will reach the maximum value, and as your hand comes closer to the controller, the cutoff value will increase.

If your hand leaves the effective range, the cutoff value will be "127" regardless of the location of your hand.

* If you wish to restore the pattern to its original state, use [INC] [DEC] or the [VALUE] dial to re-select the same pattern. The next time that the pattern repeats, it will return to its original settings.

* The resonance value will not increase beyond the value specified by the Resonance Limiter.

 "Specifying the Variable Range of Resonance (Resonance Limiter)" (p. 164)

.....

Controlling a specific range

If you wish to use the DBeam Controller to control only a specific range of cutoff or resonance, you can use the Beam Range Lower and Upper System parameters to specify the lower and upper limits of the variation. This will allow you to utilize the full valid range of the DBeam Controller, so you can control the tonal change with precision.

 "Specifying How the DBeam Controller Will Function" (p. 165)

.....

11:Part Pan-A (Part Pan All)

Hand movement will modify the pan of all parts.

As your hand comes closer to the controller the pan will move toward the right, and as your hand is taken away from the controller the pan will move toward the left.

If your hand leaves the effective range, the part pan value will be "0" regardless of the location of your hand.

* If you wish to restore the pattern to its original state, use [INC] [DEC] or the [VALUE] dial to re-select the same pattern. The next time that the pattern repeats, it will return to its original settings.

12:Part Pan-S (Part Pan Single)

Hand movement will modify the pan of the current part.

As your hand comes closer to the controller the pan will move toward the right, and as your hand is taken away from the controller the pan will move toward the left.

If your hand leaves the effective range, the part pan value will be “0” regardless of the location of your hand.

** If you wish to restore the pattern to its original state, use [INC] [DEC] or the [VALUE] dial to re-select the same pattern. The next time that the pattern repeats, it will return to its original settings.*

13:Cross Pan

Hand movement will modify the pan settings of the various parts by exchanging them.

If your hand leaves the effective range, the part pan value will be “0” regardless of the location of your hand.

** If you wish to restore the pattern to its original state, use [INC] [DEC] or the [VALUE] dial to re-select the same pattern. The next time that the pattern repeats, it will return to its original settings.*

14:Cros Drm Pan (Cross Drum Pan)

Hand movement will exchange the pan settings of the rhythm part and of the other parts.

If your hand leaves the effective range, the part pan value will be “0” regardless of the location of your hand.

** If you wish to restore the pattern to its original state, use [INC] [DEC] or the [VALUE] dial to re-select the same pattern. The next time that the pattern repeats, it will return to its original settings.*

15:Key Shift-A (Key Shift All)

Hand movement will modify the Part Key Shift settings of all parts.

As your hand comes closer to the controller, the Part Key Shift value will increase.

If your hand is outside of the effective range, the Part Key Shift value will be “0” regardless of the location of your hand.

16:Key Shift-S (Key Shift Single)

Hand movement will modify the Part Key Shift settings of the current part.

As your hand comes closer to the controller, the Part Key Shift value will increase.

If your hand is outside of the effective range, the Part Key Shift value will be “0” regardless of the location of your hand.

17:Reverb Level

Hand movement will modify the Part Reverb Level of all parts.

As your hand comes closer to the controller, the Part Reverb Level will increase.

If your hand leaves the effective range, the Part Reverb Level value will be “0” regardless of the location of your hand.

** If you wish to restore the pattern to its original state, use [INC] [DEC] or the [VALUE] dial to re-select the same pattern. The next time that the pattern repeats, it will return to its original settings.*

18:Delay Level

Hand movement will modify the Part Delay Level of all parts.

As your hand comes closer to the controller, the Part Delay Level will increase.

If your hand leaves the effective range, the Part Delay Level value will be “0” regardless of the location of your hand.

** If you wish to restore the pattern to its original state, use [INC] [DEC] or the [VALUE] dial to re-select the same pattern. The next time that the pattern repeats, it will return to its original settings.*

19:EFX Ctrl1 (EFX Control 1)

Hand movement will modify the parameter that is assigned to the [CTRL1] knob of the currently selected EFX.

If your hand leaves the effective range, the parameter value will be “0” regardless of the location of your hand.

** If you wish to restore the pattern to its original state, use [INC] [DEC] or the [VALUE] dial to re-select the same pattern. The next time that the pattern repeats, it will return to its original settings.*

20:EFX Ctrl2 (EFX Control 2)

Hand movement will modify the parameter that is assigned to the [CTRL2] knob of the currently selected EFX.

If your hand leaves the effective range, the parameter value will be “0” regardless of the location of your hand.

** If you wish to restore the pattern to its original state, use [INC] [DEC] or the [VALUE] dial to re-select the same pattern. The next time that the pattern repeats, it will return to its original settings.*

21:EFX Ctrl3 (EFX Control 3)

Hand movement will modify the parameter that is assigned to the [CTRL3] knob of the currently selected EFX.

If your hand leaves the effective range, the parameter value will be “0” regardless of the location of your hand.

** If you wish to restore the pattern to its original state, use [INC] [DEC] or the [VALUE] dial to re-select the same pattern. The next time that the pattern repeats, it will return to its original settings.*

22:Start/Stop

The DBeam Controller will have the same function as [PLAY]/ [STOP].

If the pattern is playing, it will stop when you place your hand over the controller, and will start when you remove your hand.

23:All Mute

When you place your hand over the controller, all parts will be muted.

When your hand leaves the effective range, the original mute settings will be restored.

24:Turntable

When you place your hand over the controller, the tempo and pitch of all parts will drop simultaneously, creating an effect similar to when a record turntable is stopped.

The closer your hand approaches the controller, the more the tempo and pitch will drop. It is effective to slowly lower your hand toward the controller.

If your hand leaves the effective range, the original tempo and pitch (Part Key Shift of “0”) will return.

25:Arp Range (Arpeggio Range)

Shading the controller with your hand will modify the Octave Range of the arpeggiator. Use this when you are playing the arpeggiator.

As your hand approaches the controller, the Octave Range will increase.

If your hand leaves the effective range, the Octave Range value will be “0.”

26:Note+Bnd (Note + Pitch Bend)

Shading the controller with your hand will sound the patch of the current part, and Pitch Bend will be applied at the same time. This is suitable for use when a sustain-type patch (such as P:A054) is selected.

As your hand approaches the controller, the pitch will rise.

If your hand leaves the effective range, the sound will stop.

The pitch of the note that will sound is shown at the right of the Type name. By holding down D BEAM CONTROLLER [ON] and pressing a keyboard pad, you can change the note that will sound.

```
D DEAM CTRL TYPE
26:Note+Bnd[A 4]
```

 The range of pitch change can be specified by the Bend Range for each patch.

☞ “Adjusting the Range of Pitch Bend (Bend Range)” (p. 60)

27:Adlib1 (Ad-Lib 1)

Shading the controller with your hand will sound the patch of the current part using notes of a specified key and scale.

As your hand approaches the controller, higher notes will sound.

The key and scale will be displayed as an abbreviation at the right of the Type name.

You can change the key by pressing a keyboard pad while you hold down the D BEAM CONTROLLER [ON] button.

You can change the scale by pressing PAGE [<] [>] while you hold down the D BEAM CONTROLLER [ON] button.

```
D DEAM CTRL TYPE
27:Adlib1[A CHR]
```

One of the following 21 types of scale can be selected.

- CHR:** Chromatic Scale
- TCH:** Tcherepnin's Scale
- SPN:** Spanish Scale
- BLS:** Blues Mixolydian Scale
- CD:** Combination of Diminished Scale
- MAJ:** Diatonic Major Scale
- MIN:** Natural Minor Scale
- HMJ:** Harmonic Major Scale
- HMI:** Harmonic minor Scale
- DH:** Double Harmonic Scale
- MMI:** Melodic Minor Scale
- GPS:** Gypsy Scale
- DOM:** Dominant Scale
- WT:** Whole Tone Scale
- HBL:** Hexatonic Blue Scale
- AUG:** Augmented Scale
- RKY:** Ryukyu Scale
- ISD:** In Sen Scale, Decending
- ISA:** In Sen Scale, Ascending
- PMJ:** Major Pentatonic Scale
- PMI:** Minor Pentatonic Scale

28:Adlib2 (Ad-Lib 2)

Shading the controller with your hand will sound the patch of the current part using notes of a specified key and scale. This lets you perform ad-lib in a narrower range than Ad-lib 1.

As your hand approaches the controller, higher notes will sound.

The key and scale will be displayed as an abbreviation at the right of the Type name.

You can change the key by pressing a keyboard pad while you hold down the D BEAM CONTROLLER [ON] button.

You can change the scale by pressing PAGE [<] [>] while you hold down the D BEAM CONTROLLER [ON] button.

The pitch range will rise or fall depending on the Octave Range setting.

The scales that can be selected are the same as for Ad-lib 1.

About the MIDI messages transmitted from the DBeam controller

The destination of the MIDI messages transmitted from the DBeam controller is determined by the Local Tx switch setting of each part.

 **“Disconnecting the Keyboard Pads from the Internal Sound Generator (Local Tx Switch)”**
(p. 169)

Chapter 10. Recording Patterns

The MC-505 lets you create your own original patterns by recording your playing on the built-in sequencer. Broadly speaking, there are two ways to record: real-time recording lets you record your playing and operations just as you perform, and step recording lets you input notes one by one. The basic recording procedure is as follows.

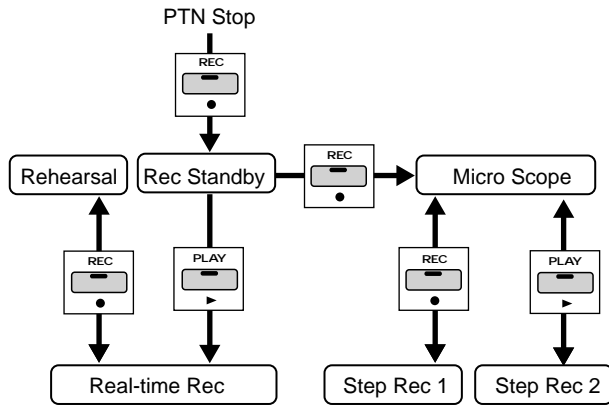

* A pattern you record is held in the temporary pattern (U:TMP). If you wish to keep a pattern that you have recorded, you must use the Pattern Write operation.

📖 “Saving Patterns You’ve Modified (Pattern Write)” (p. 26)

Undo/Redo

If you are not happy with the pattern that was recorded, you can press the [UNDO/REDO] button to return the playback data to the state before it was recorded.

📖 “Canceling the Previous Operation (Undo/Redo)” (p. 18)

Recording Your Playing As You Perform (Real-Time Recording)

Real-time recording is a method in which your playing on a keyboard or the keyboard pads and your controller operations are recorded just as they occur. The MC-505 uses two types of real-time recording, and different types of data are recorded using different methods.

Loop Mix recording

Recording will take place repeatedly from the beginning to the end of the pattern. If data was already recorded in the pattern from a previous pass, it will remain, and the newly recorded data will be combined with it. Note messages are recorded using this method.

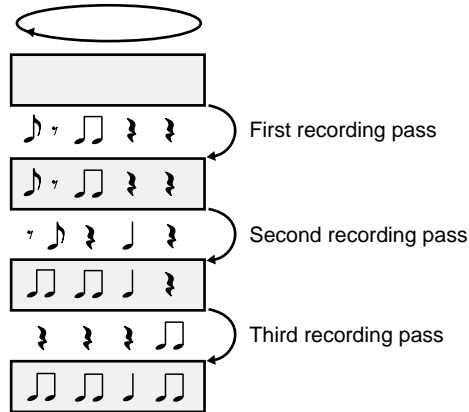

Loop Replace recording

Recording will take place repeatedly from the beginning to the end of the pattern. If data was already recorded in the pattern from a previous pass, it will be erased and replaced by the new recording. Controller operations, etc. are recorded using this method.

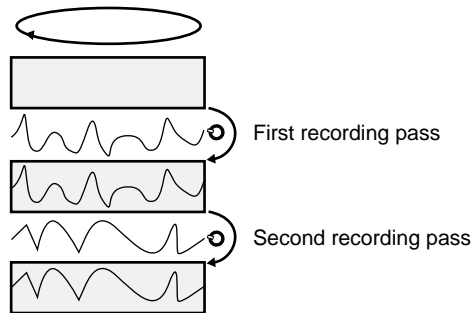

Recording Procedure

Before you begin, select the pattern that will be recorded. If you wish to record a new pattern, select U:TMP (the temporary pattern). If you wish to re-record a preset pattern, etc., select that pattern.

* If something has already been recorded in the temporary pattern, use the Pattern Initialize operation to clear any musical data from the temporary pattern (p. 27).

1. Press [REC].

The indicator will blink, and the Recording Standby page will appear.

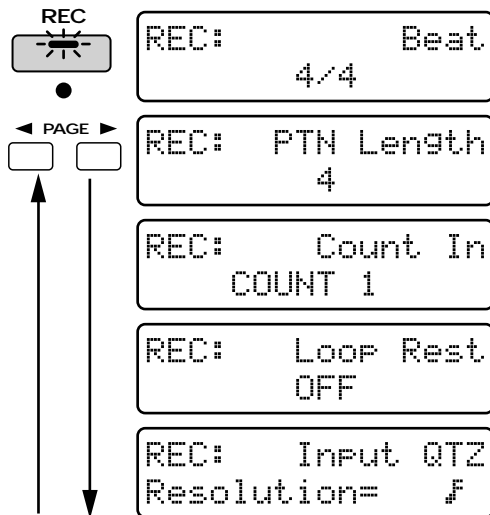

2. Before you start recording, set the recording parameters.

There are five recording parameters, as described below. Use PAGE [<] [>] to select a parameter, and use [INC] [DEC] or the [VALUE] dial to set the value.

Beat

Specifies the time signature of the pattern to be newly recorded.

Range: 2/4–7/4, 5/8–7/8, 9/8, 12/8, 9/16, 11/16, 13/16, 15/16, 17/16, 19/16

PTN Length (Pattern Length)

Specifies the length of the pattern to be newly recorded.

Range: 1–32 measures

Count In

Specifies how recording will begin.

Range:

COUNT 0: Recording will begin the instant you press [PLAY].

COUNT 1, 2: A count-in of one measure (or two measures) will sound when you press[PLAY], and recording will begin when the count-in ends.

WAIT NOTE: Recording will begin when you press a keyboard pad or the hold pedal.

Loop Rest

Turn this on if you want to record smoothly across the boundary of a pattern.

Range: OFF, ON



For details on using Loop Rest...

☞ “Recording Smoothly Across Pattern Boundaries” (p. 131)

Input QTZ (Input Quantize)

By using Input Quantize you can correct the timing of the notes you play as they are recorded.

Range: OFF, ♯ ♯♯ ♯♯♯ ♯♯♯♯ ♯♯♯♯♯

Set this to the shortest note value that will occur in the phrase you wish to record.

At this time, you can use the [TIMING] knob to specify the Strength value.

When this setting is “OFF,” the notes will be recorded at the timing that you play them.

* It is not possible to modify the Beat of a pattern that has already been recorded. Nor is it possible to shorten the Pattern Length. If you wish to modify these values, use the Pattern Initialize (p. 27) operation to clear the contents of the pattern before you make settings.

About the metronome

If you wish to record along with the metronome, press [METRONOME] to turn on the metronome. Press [METRONOME] once again to turn it off.

Even in cases other than real-time recording, you can press [METRONOME] to switch the metronome on or off.



Adjusting the metronome volume...

☞ “Adjusting the Metronome Volume (Metronome Level)” (p. 166)

3. Select the part that you wish to record by pressing the PART button for that part.

This will select the part that will be recorded (the Recording Part).

The indicator of the button you pressed will light.

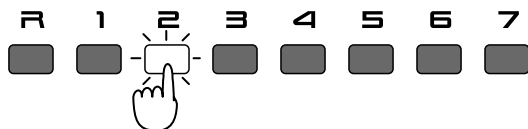

4. When preparations are complete, you can start recording with the selected recording method. Recording can be started in one of the following two ways.

When the Count In setting is 0COUNT 0B20

Press [PLAY], and recording will begin after the specified count-in.

* The count-in will not sound when the metronome is off.

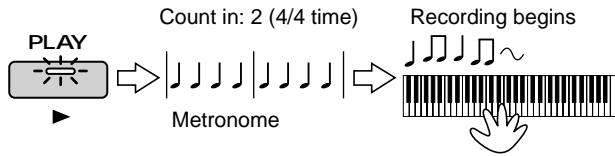
**When the Count In setting is 0WAIT NOTE0**

Recording will begin the instant you play a note on an external MIDI keyboard, press one of the keyboard pads, or press the Hold pedal.

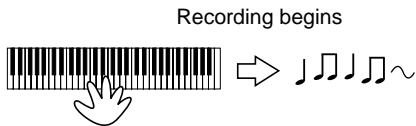

* If you want to use the keyboard pads to record, make sure that the [PTN CALL] and [RPS] indicators are dark.

When recording begins, the [REC] indicator will light. The CURRENT display will show the number of measures in the entire pattern, and the NEXT display will show the currently recorded measure and the beat.

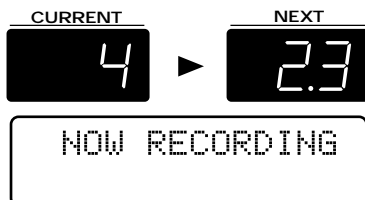

Recording can be continued repeatedly from the beginning to the end of the pattern. Once notes (note messages) have been recorded from the keyboard or the keyboard pads, they will remain without being erased, allowing you to continue “layering” your performance.

5. When you are finished recording, press [STOP].

The pattern that you recorded will be held in the temporary pattern (U:TMP). If you are happy with the pattern that was recorded, use the Pattern Write operation to save it as a user pattern.

“Saving Patterns You’ve Modified (Pattern Write)” (p. 26)

Changing the Recording Part While You Record

You are free to change the recording part while you record. By changing the recording part successively from drums, bass, chords and melody, etc., you can continue recording without stopping your creative flow.

To change the recording part, switch from Recording mode to Rehearsal mode. In Rehearsal mode, your playing on the keyboard or keyboard pads will not be recorded, and this lets you practice along with the previously recorded performance until you are ready to continue recording.

1. During recording, press [REC].

The button indicator will blink, and you will enter Rehearsal mode. The following display will appear.

**2. To change the recording part, press the PART button for the part that you wish to record.****3. Press [REC] once again to leave Rehearsal mode and return to normal Recording mode.**

.....
In Rehearsal mode, you can use [INC] [DEC] or the [VALUE] dial and the [TIMING] knob to modify the Input Quantize settings.
.....

Recording an Arpeggio Performance**1. Before recording, make the desired arpeggio settings (p. 105).**

Press ARPEGGIATOR [ON] to turn the arpeggiator on.

2. Make preparations for recording (p. 127).**3. When you are ready, use one of the following methods to begin recording.****When the Count In setting is 00B20**

When you press [PLAY], recording will begin after the specified count-in. Press a chord at the moment that recording begins.

* The count-in will not sound when the metronome is off.

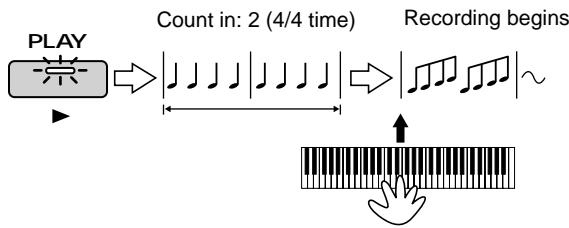

When the Count In setting is 0 WAIT NOTE 0

Arpeggio performance and recording will begin at the moment that you play a chord on the keyboard or the keyboard pads.

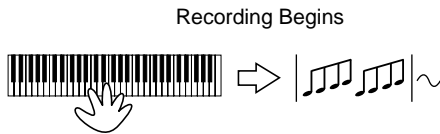

* If you want to use the keyboard pads to record, make sure that the [PTN CALL] and [RPS] indicators are dark.

When recording begins, the [REC] indicator will light.

4. When you are finished recording, press [STOP].

Recording Knob Movements (Modify Data)

1. Make preparations for recording (p. 127).

2. When you are ready, begin recording.

When recording begins, the [REC] indicator will light. When you operate the knobs during recording, the knob movements will be recorded from the time that they are moved.

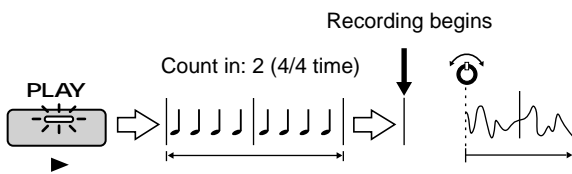

3. When you are finished recording, press [STOP].

You can record the parameters of the knobs and buttons of the PITCH section, the FILTER/AMPLIFIER section, ENVELOPE section, LFO1 section, PORTAMENTO section, REVERB section, DELAY section and EFX section. If you have modified the sound of a patch, the modifications will be recorded in each recording part as control change messages. If you have modified the settings of a tone or rhythm group, the modifications will be recorded in the [MUTE CTRL] part as system exclusive messages.

Movements of the knobs in the REVERB/DELAY/EFX sections will also be recorded in the [MUTE CTRL] part as system exclusive data.

- ☞ “Using the Knobs to Modify the Sound During Playback (Real-Time Modify)” (p. 28)
- ☞ “Musical Data Handled in Microscope Mode” (p. 141)

Recording will take place repeatedly from the beginning to the end of the pattern. Unlike recording of note messages, Modify data for the same knob will be re-written (overwritten) each time the pattern repeats, but you may successively layer Modify data for different knobs.

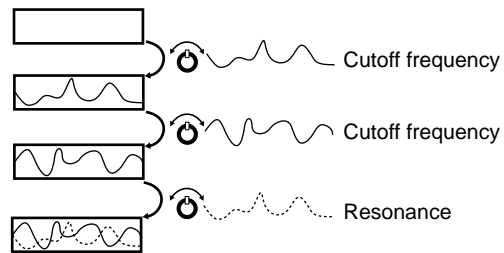

Recording Part Mixer Movements

1. Before you begin recording, select the parameter that you wish to modify using the part mixer (p. 24).

2. Make preparations for recording (p. 127).

Any part [R]-[7] can be selected as the recording part. In actual recording, the part which corresponds to the slider that you operate will be recorded (regardless of the part you selected to be the recording part).

3. When you are ready, begin recording.

When recording begins, the [REC] indicator will light. During recording, operate the part mixer and the movements will be recording when you make them. Movements for all eight parts can be recording simultaneously.

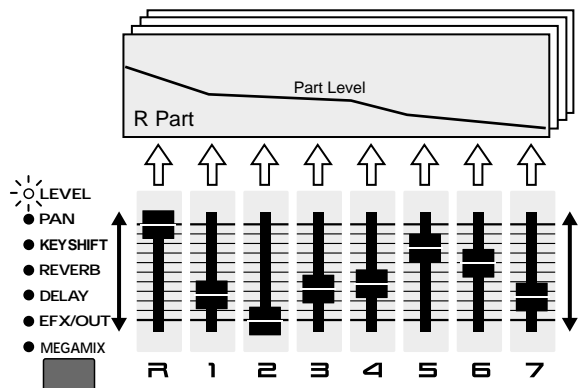

4. When you are finished recording, press [STOP].

Recording will take place repeatedly from the beginning to the end of the pattern. You can change part mixer parameters as you record, for example recording Part Volume on the first pass, Part Pan on the second pass, etc.

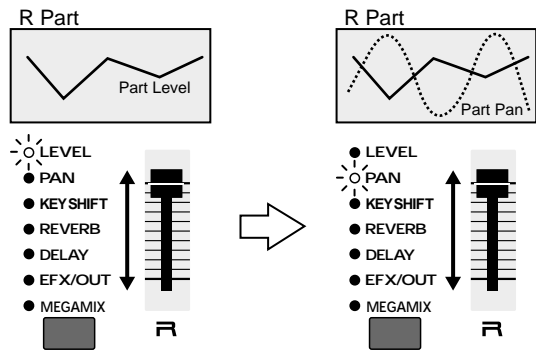

Recording Smoothly Across Pattern Boundaries

When you record knob movements or arpeggios, unwanted data may sometimes be recorded at the boundary of the pattern if you attempted to record accurately from the beginning to the end. For example, if you wish to record across pattern boundaries, the following data might be recorded.

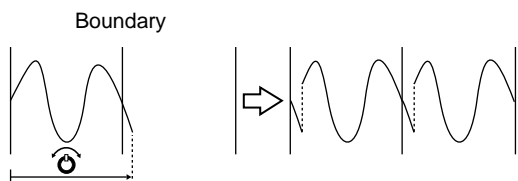

In such cases, turn the Loop Rest function on when you set the recording parameters. When Loop Rest is on, a one-measure blank will be temporarily created between pattern boundaries. By recording across this blank measure, you can record smoothly across pattern boundaries. If the metronome is on, only the count will sound while the blank measure elapses.

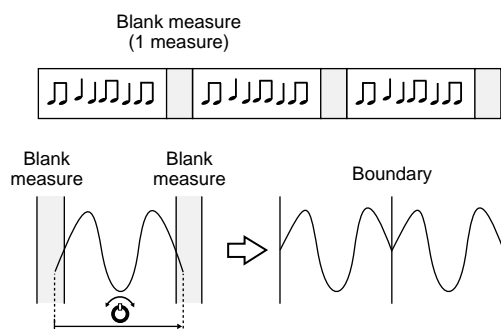

Recording the Mute Settings

Changes in the mute settings for parts or rhythm groups that you make during recording can be recorded in the pattern.

1. Make preparations for recording (p. 127).

For the recording part, specify [MUTE CTRL].

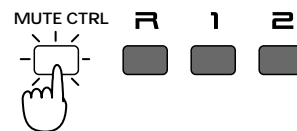

* If the recording part is not set to [MUTE CTRL], changes in the mute settings for parts or rhythm groups will not be recorded. Also, [MUTE CTRL] can be selected only if the pattern is stopped.

2. When you are ready, begin recording.

3. Press [PART MUTE] and [RHYTHM MUTE] so you can make mute settings.

If you mute a part or rhythm group during recording, the mute settings will be recorded.

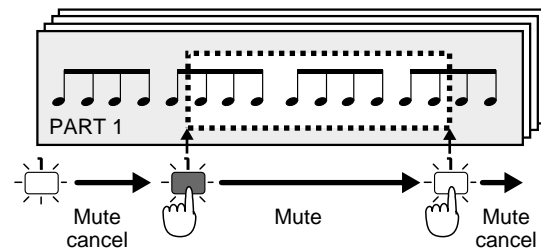

4. When you are finished recording, press [STOP].

Recording Changes in Tempo

The standard tempo of a pattern is memorized when you perform the Pattern Write operation. However you can record tempo changes by modifying the tempo as you record.

1. Make preparations for recording (p. 127).

Specify [MUTE CTRL] as the recording part.

* If the recording part is not set to [MUTE CTRL], tempo changes will not be recorded. Also, [MUTE CTRL] can be selected as the recording part only when the pattern is stopped.

2. When you are ready, begin recording.

When recording begins, the [REC] indicator will light. During recording, you can record tempo changes by pressing [TEMPO/MIXER] and using the [VALUE] dial to modify the tempo.

* Tempo changes made using [TAP] will not be recorded.

3. When you are finished recording, press [STOP].

Erasing Unwanted Data While You Record (Real-Time Erase)

Real-Time Erase is a function that lets you erase only the unwanted data that you specify a certain key or range of keys during real-time recording.

In particular, this is convenient when you are recording the rhythm part, since you can erase a specific rhythm tone.

1. During recording, press [REALTIME ERASE].

You will enter Real-Time Erase mode, and the following display will appear.



2. Use [INC] [DEC] or the [VALUE] dial to select the type of data that you wish to erase.

Range:

ALL: All musical data in the recording part will be erased.

NOTE: Notes in the specified range will be erased.

PC: Program changes will be erased.

CC: All control changes will be erased.

BEND: Pitch bend will be erased.

P-AFT: Polyphonic aftertouch will be erased.

C-AFT: Channel aftertouch will be erased.

SYS-EX: System exclusive data messages will be erased.

TEMPO: Tempo data will be erased.

MUTE: Mute data will be erased.

CC#0-CC#127: Control changes of the selected controller number will be erased.

For knob and part mixer settings, you can also operate the corresponding front panel knob to select that data (control change) for erasure.

The following knobs and part mixer settings can be selected.



- [COARSE TUNE]
- [FINE TUNE]
- [CUTOFF]
- [RESONANCE]
- [TONE LEVEL]
- [TONE PAN]
- [P-ENV DEPTH]
- [P-ENV A]
- [P-ENV D]
- [P-ENV S]
- [P-ENV R]
- [F-ENV DEPTH]
- [F-ENV A]
- [F-ENV D]
- [F-ENV S]
- [F-ENV R]
- [A-ENV A]
- [A-ENV D]
- [A-ENV S]
- [A-ENV R]
- [LFO1 P-DEPTH]
- [LFO1 F-DEPTH]
- [LFO1 A-DEPTH]
- [LFO1 RATE]
- [TIME]
- [PART LEVEL]
- [PART PAN]
- [PART KEY SHIFT]
- [PART REVERB]
- [PART DELAY]
- [PART EFX/OUT]

3. Press [REC] to erase the unwanted data.

The specified data will be erased while you press the button.

When "SYS-EX," "TEMPO" or "MUTE" are selected, the data will be erased from the [MUTE CTRL] part regardless of the recording part.

.....
 If you select "NOTE" as the data to be erased, you can press the keyboard pad to erase only the specified note messages. Notes will be erased while you press the keyboard pad.

If you wish to erase notes of a specific range, press keyboard pads to indicate the top and bottom of the range. The range can also be specified from an external MIDI keyboard.

.....

4. When you have finished, press [EXIT] or [REALTIME ERASE] to return to normal recording mode.

Recording Notes One at a Time (Step Recording)

Step Recording allows you to record notes one at a time. This method is a convenient way to enter notes for which accurate timing is essential, such as percussion instruments or bass.

Only note messages can be recorded using step recording.

The following two methods of step recording can be used. Use each method as appropriate.

Step recording 1

Enter notes successively as you specify the location of each note. This method does not let you hear the performance as you record.

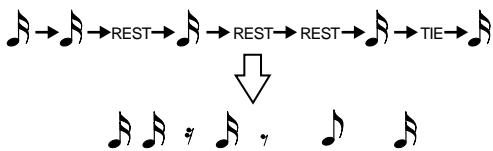

Step recording 2

Select a note to be input, and while listening to the performance, specify locations on a grid where you wish to place that note. When used for the rhythm part, this method is suitable for drum recording, since it allows you to input notes for each rhythm tone separately. Even for parts 1-7, you can create sequenced phrases easily while listening to the performance.

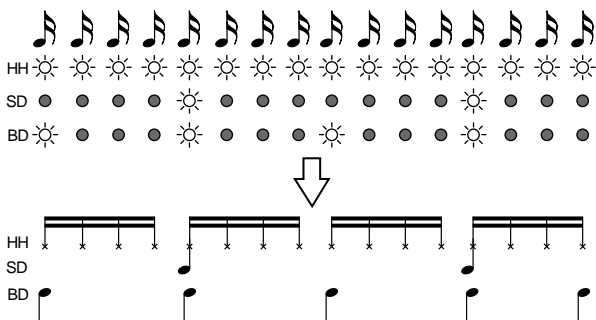

.....
 In addition to the above two methods of recording, there is a Microscope function that lets you modify the notes that you input. During recording, you can move freely between the step input page and the Microscope page.

Recording Procedure

First select the pattern that you wish to record. If you wish to record a new pattern, select U:TMP (temporary pattern). If you wish to re-record a preset pattern, etc., select that pattern.

* If data has already been recorded in the temporary pattern, use the Pattern Initialize operation to clear the temporary pattern of all data.

1. Press [REC].

The indicator will blink, and the recording standby page will appear.

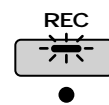

2. Before you begin recording, set the recording parameters (p. 128).

* During step recording, the Count In and Loop Rest settings are ignored.

3. Press a PART button to specify the part that you wish to record (the recording part).

The indicator of the button you pressed will light.

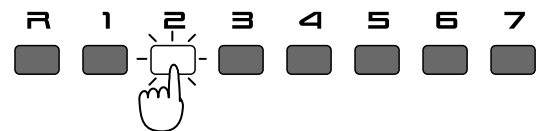

4. Press [REC] once again.

The Microscope page will appear, and the input location will appear in the display.

CURRENT: Indicates the measure and beat
NEXT: Indicates the clock

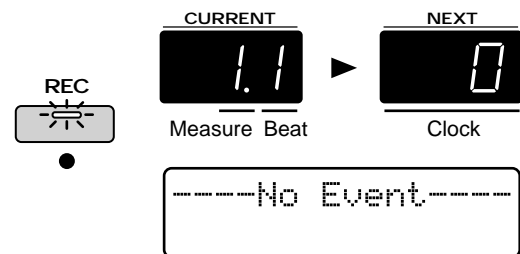

.....
 "Clock" is a unit of timing that indicates the location of a note. On the MC-505, one clock is 1/96th of a quarter note.

If you are using step recording method 1 to record

Proceed to "Recording Notes One by One (Step Recording 1)."

If you are using step recording method 2 to record

Proceed to "Recording Individual Notes to Grid Locations (Step Recording 2)" (p. 136).

Recording Notes One by One (Step Recording 1)

5. Press [REC] to begin recording.

The [REC] indicators will light.
The following display will appear.

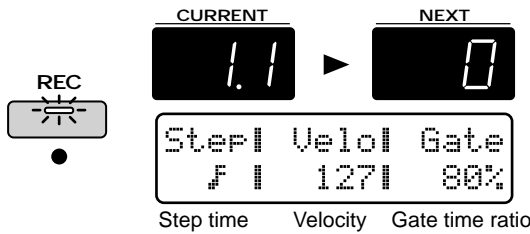

6. Before inputting notes, select the Step Time, Velocity, and Gate Time Ratio.

Step Time

Select the length of the note that will be input (the duration from when a key is pressed until the next key is pressed).

Range: **F F F F**

- x : Step Time =24
- r : Step Time =12
- el : Step Time =32
- xl : Step Time =16

.....
The Step Time for a quarter note is 96.
.....

Press [SCALE] several times to select the step time. The step time will cycle through the choices each time you press the button. Select the note value that you wish to input.

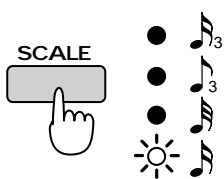

.....
You can also rotate the [VALUE] dial to select a note

value. At this time, you can select note values other than the above four.

Velocity

Specifies the strength of the note. As this value is increased, the note will be played more strongly. Various velocity values are assigned to each PART button [R]-[7].

To select the desired velocity value, press one of these buttons.

The indicator of the button you pressed will light.

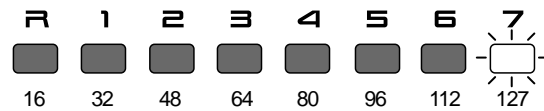

Gate Time Ratio

Specifies the time from when the key is pressed until it is released (Gate Time), as a proportion of the Step Time. Lower settings of this value will produce shorter notes, and higher settings will produce longer notes. Normally, you should select a setting of about 80%.

Select 50% for staccato notes, and 100% for tenuto notes.

Various gate time ratio values are assigned to each RHYTHM button [BD]-[OTHERS].

Press one of these buttons to select the desired gate time ratio.

The indicator of the button you pressed will light.

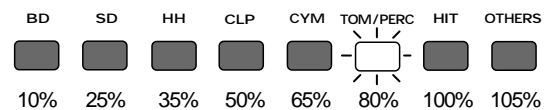

* When the Rhythm part is the recording part, gate time will be input with a fixed value, so it is unnecessary to specify the gate time ratio.

7. Play an external MIDI keyboard or the keyboard pads to input notes.

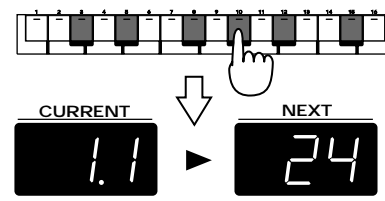

Notes will be input when you release the key, and you will then be ready to input the next note.

Each time you input a note, the input location will advance by the length of the Step Time. Also, the indicator above the keyboard pads will advance by the length of the selected Step Time.

8. Repeat steps 6 and 7 to input the notes.

The Step Time, Gate Time Ratio and Velocity settings of the previously input note are remembered. If you wish to use the same settings for the next note, there is no need to change the values of these parameters.

* In Step Recording 1, notes are always overwritten (replaced) when they are recorded, meaning that if you input notes in a location that already contained notes, the previously recorded notes will be erased.

9. When you finish inputting notes, press [STOP].

The pattern you recorded will be in the Temporary Pattern (U:TMP). If you are happy with the pattern that you recorded, use the Pattern Write operation to save it as a user pattern.

"Savin Patterns You've Modified (Pattern Write)" (p. 26)

Step Time and Gate Time

In general, Step Time is the length from one note to the next, and Gate Time is the duration that the note will actually sound (i.e., the length from when the note is pressed until it is released).

For example, if you are inputting 16th notes (Step Time = 24) with Gate Time Ratio = 80%, the actual Gate Time will be input as 19.

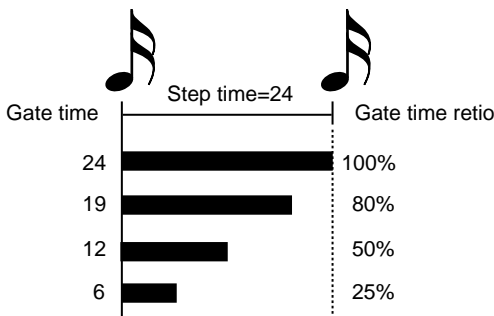

Changing the Velocity/Gate Time values assigned to each button

The Velocity and Gate Time Ratio values that are assigned to each PART/RHYTHM button are only the factory settings, and you are free to modify these if desired.

To modify the assigned values, hold down the PART/RHYTHM button whose setting you wish to modify, and use [INC] [DEC] or the [VALUE] dial to modify the value.

Range:
Velocity: 0-127
Gate Time Ratio: 1-200%

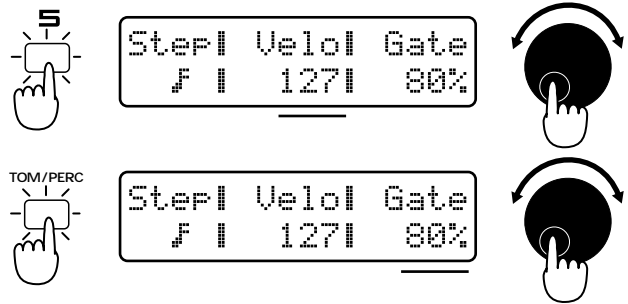

Various Ways to Input Notes

Inputting a chord

Hold down the notes that make up the chord, and release all notes simultaneously. The chord will not be input as long as even one note remains pressed, so you can change notes to correct the chord.

Inputting a rest

Set the Step Time to the length of the desired rest, and press [FWD/REST].

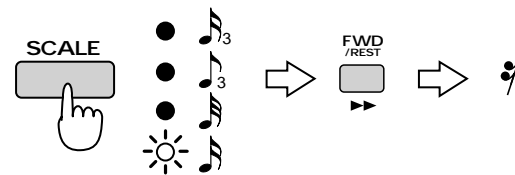

Inputting a tie

Input the first note that you wish to tie, and press [BWD/TIE]. This method can also be used to input notes longer than a 16th note, or dotted notes, etc.

Example 1

To enter a quarter note, use [SCALE] to make the second indicator from the top light and input a note, and then press [BWD] twice without changing the Step Time. (Alternatively, you can input a 16th note and press [BWD] three times without changing the Step Time.)

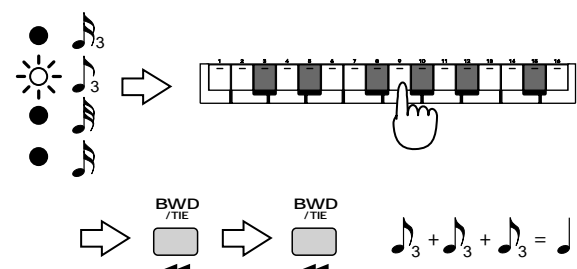

Example 2

To enter a dotted eighth note, input a 16th note and then press [BWD] twice without changing the Step Time.

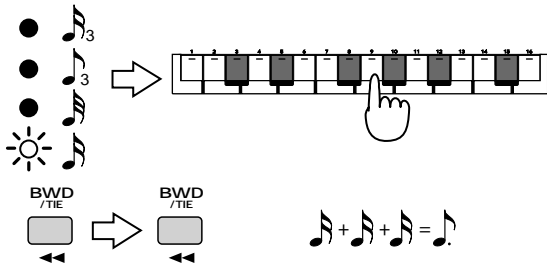

Applying a slide effect

By setting the Gate Time Ratio to 100% or more (for example, to 105% for a 16th note phrase) and inputting steps, you can input legato phrases. An easy way to apply a slide effect is to use legato input in conjunction with a patch such as P:A008 or P:A015 which applies a slide effect for notes that are played legato.

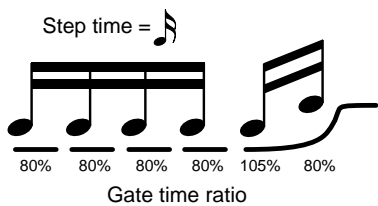

For the phrase which is applied a slide effect, you can operate the PORTAMENTO [TIME] knob during playback to control the depth of the slide effect.

For a patch that applies a slide effect for notes that are played legato, set parameters as follows (p. 57).

- Solo Switch:** ON
- Solo Legato Switch:** ON
- Portamento Switch:** ON
- Portamento Time:** 5 – 20
- Portamento Mode:** LEGATO

Slide effect

Slide refers to a performance technique used on string instruments such as guitar or bass, whereby after the string is plucked, the fingers are slid to another fret without picking a second time. This produces a smooth transition between the pitches of the two notes.

If you make a mistake during input

Hold down [SHIFT] and press [BWD/TIE] to delete the note that was last input. At this time, the note that was deleted will be sounded as confirmation.

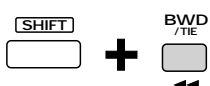

Recording Individual Notes to Grid Locations (Step Recording 2)

5. Press [PLAY] to begin recording.

The [PLAY] and [REC] indicators will light. The CURRENT display will indicate the current recording input area within the pattern, and the NEXT display will indicate the playback location. The screen display will differ according to whether the recording part is the rhythm part or another part. In the following illustration, the current recording input area is measure 1, and the second beat of measure 1 is being played back.

Rhythm part

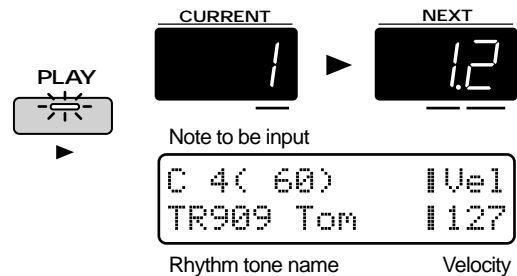

Part 1-7

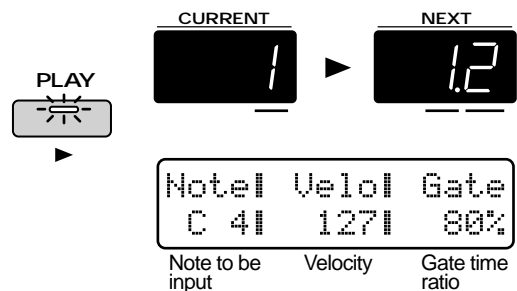

6. Before you input notes, select the Scale, the note (rhythm tone) to be input, the velocity, and the gate time ratio (for parts 1D7).

Scale

Select the note value of the notes that you wish to input. The recording input area is determined by the scale that you select.

Range: ♯ ♯ ♯ ♯

x : Keyboard pads [1]–[16] will correspond to a recording input area of one measure, and can be used to enter 16th notes.

r : Keyboard pads [1]–[16] will correspond to a recording input area of two beats, and can be used to enter 32nd notes.

e1 : Keyboard pads [1]–[12] will correspond to a recording input area of 1 measure, and can be used to enter 8th note triplets.

xl : Keyboard pads [1]–[12] will correspond to a

recording input area of two beats, and can be used to enter 16th note triplets.

Press [SCALE] to select the scale. Each time you press the button, you will cycle through the available scales. Make the indicator light for the desired scale.

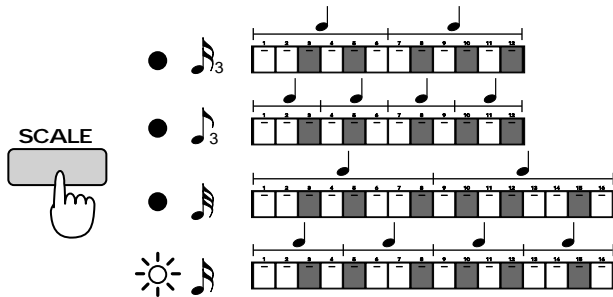

Selecting the note (rhythm tone) to input

Hold down [SHIFT] and press the keyboard pad to select the note (rhythm tone). While [SHIFT] is pressed, the notes (rhythm tones) will be assigned to the keyboard pads in the same way as when you play. Play the keyboard pads to select the note that you wish to enter. After playing the note that you wish to input, release [SHIFT] and the last-sounded note will be selected.

If you wish to change the range of the keyboard pads, use OCTAVE [-] [+].

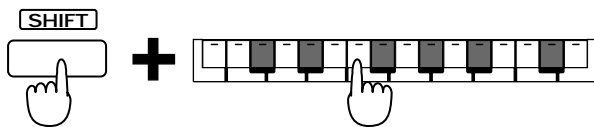

You can also hold down [TONE SELECT] and press a keyboard pad or rotate the [VALUE] dial to select a note.

Velocity

Specifies the strength of the note. Higher settings will produce a more strongly played note.

Different velocities are assigned to each of the PART buttons [R]-[7].

Press one of these buttons to select the desired velocity value.

The indicator of the button you pressed will light.

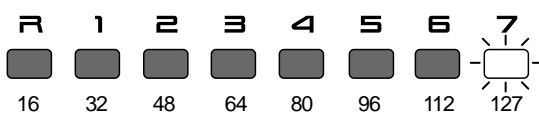

Gate Time Ratio

Specifies the time from when the note is pressed until it is released (the Gate Time), as a ratio relative to the Step Time. Set a low value if you want notes to be cut off sharply, or a higher value if you want notes to be sustained. Normally you will select a value of approximately 80%.

To enter staccato notes select 50%, and to enter tenuto notes select 100%.

Different Gate Time Ratio values are assigned to each of the RHYTHM buttons [BD]-[OTHERS].

Press any button to select the desired gate time ratio value.

The indicator of the button you pressed will light.

* Since the rhythm part is always input with a fixed gate time, it is not necessary to set the gate time ratio value.

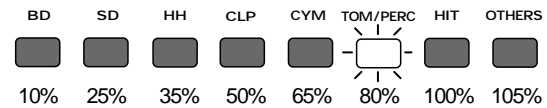

The velocity and gate time ratio values assigned to each button are merely the factory settings, and you are free to modify these.

📖 “Changing the Velocity/Gate Time values assigned to each button” (p. 135)

7. Press the keyboard pads that correspond to the locations where you wish to enter a note message. You may start at any location. The indicator of each keyboard pad you press will light.

To cancel a note location that you input, press that keyboard pad once again to make the indicator go dark.

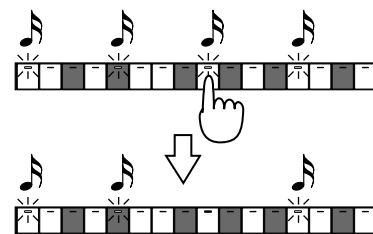

If the pattern length is 1 measure, the beat is 4/4 and the scale is 16th notes, you can input as follows.

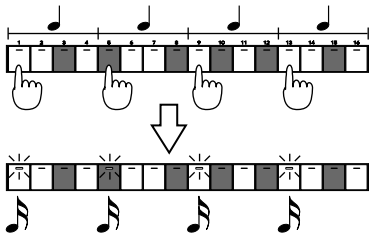

Notes that are input will be layered (mixed) onto previous notes.

During recording, the pattern will be played back repeatedly, and the newly recorded note messages will be added to the playback each time.

8. While you listen to the playback repeat, repeat steps 6 and 7 to input the notes.

Settings for scale, the note (rhythm tone) to be input, velocity and gate time ratio will be held over from the settings of the previous note. If you wish to use the same settings for the next note, you need not change the settings.

* If you change the note (rhythm tone) that you are inputting, the locations of previously-input notes (rhythm tones) of other pitches will not be displayed.

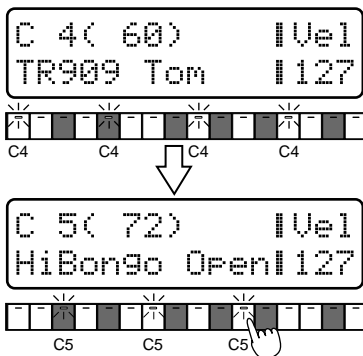

To move the recording input area, use [FWD] and [BWD].

Pressing [FWD] will advance the recording input area by 1 measure (or 2 beats).

Pressing [BWD] will return the recording input area by 1 measure (or 2 beats).

If the pattern length is set to "2 measures," the beat is "4/4" and the scale "32nd notes," the recording input area will move as follows. When the recording input area is on beat 3 and 4, a "-" (bar) will be added at the right of the measure indication in the CURRENT display.

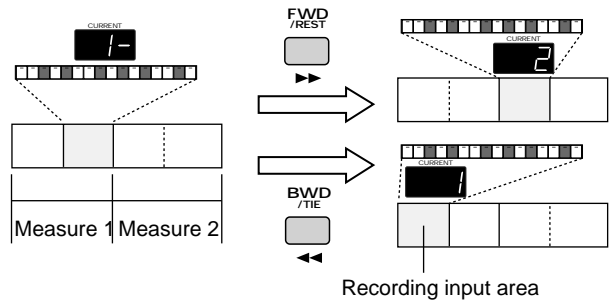

9. When you finish inputting notes, press [STOP].

The pattern you record will be in the temporary pattern (U:TMP). If you are happy with the pattern you recorded, use the Pattern Write operation to save the pattern as a user pattern.

"Saving Patterns You've Modified (Pattern Write)" (p. 26)

Real-time input using the TAP button

By pressing the [TAP] button at the timing at which you wish to input notes (rhythm tones), you can input notes at the nearest grid location.

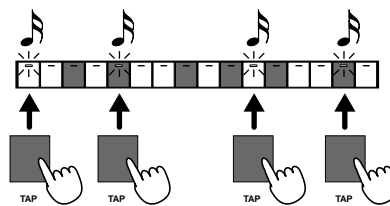

Re-input using the slider

While you hold down a keyboard pad that is lit, the display will show the data for the note that was input. At this time, you can continue holding the keyboard pad and use the part sliders to modify the various data values of the note that was input. Using this capability, you can input all the notes at the same pitch, concerning yourself only with their timing. Afterwards, you can modify the pitch and velocity of each note as desired to easily create a sequenced phrase.

Part slider [R]

Adjusts the pitch of the note that was input, within a 1-octave range.

Range: C-B

Part slider [1]

Adjusts the pitch of the note in 1-octave steps.

Range: -1-9

.....
You can use OCTAVE [+] [-] to do the same thing.
.....

Part slider [2]

Adjusts the pitch of the note, over the entire pitch range.
Range: C-1–G9

.....
You can use [INC] [DEC] or [VALUE] to do the same thing.
.....

Part slider [3]

Adjusts the velocity of the note.
Range: 1–63

Part slider [4]

Adjusts the velocity of the note.
Range: 64–127

Part slider [5]

Adjusts the gate time ratio of the note.
* This is not available for the rhythm part.
Range: 1–50%

Part slider [6]

Adjusts the gate time ratio of the note.
* This is not available for the rhythm part.
Range: 51–100%

Part slider [7]

Adjusts the gate time ratio of the note.
* This is not available for the rhythm part.
Range: 101–200%

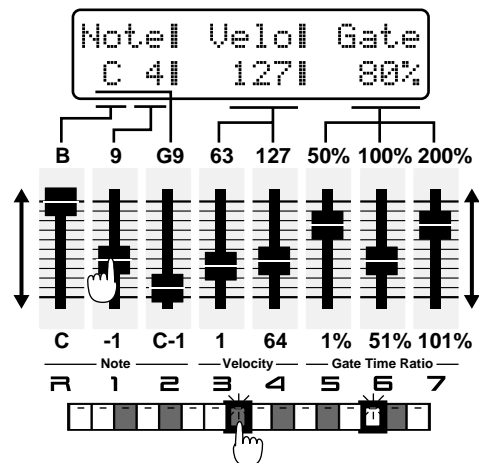

* Of the previously-input note data that is shown in the display, gate time ratio values may show a disparity of several percent from the values that were actually input. In particular, the disparity will be larger for notes that were input with a small scale.

Various Ways to Input Notes

Inputting complex rhythms

By changing the scale while you record, you can input rhythms that use complex note values.

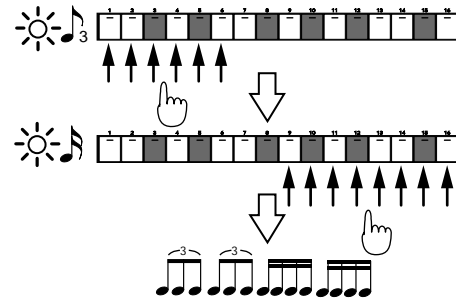

Applying a slide effect

An easy way to apply a slide effect is to use legato input in conjunction with a patch such as P:A008 or P:A015 that applies a slide effect for notes that are played legato.

First, input the notes with a Gate Time Ratio setting of approximately 80%, and then use the slider to raise the Gate Time Ratio to 100% or above (for example 105% for a 16th note phrase) only for the notes that you want to be played legato; i.e., the notes to which the slide effect will apply.

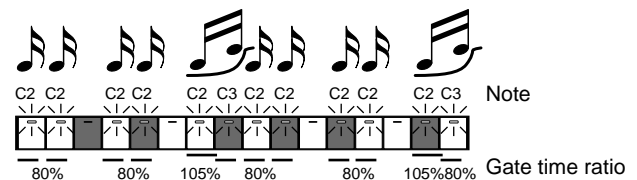

For the phrase which is applied a slide effect, you can operate the PORTAMENTO [TIME] knob during play-back to control the depth of the slide effect.

For a patch that applies a slide effect for notes that are played legato, set parameters as follows (p. 57).

- Solo Switch: ON
- Solo Legato Switch: ON
- Portamento Switch: ON
- Portamento Time: 5–20
- Portamento Mode: LEGATO

* Ties cannot be input.

* If you record the rhythm part in real time, and then use Step Recording 2, the previously input notes can be viewed on the front panel. However, you will see only those notes that coincide with grid locations of the currently selected scale.

Also, if you change the scale during recording, notes that had until then been visible may no longer be shown on the front panel.

For example, if you input 32nd notes and then change the scale to 16th notes, any notes that had been input at keyboard pad locations 2, 4, 6, 8, 10, 12, 14 or 16 will not be displayed.

Individually Editing Musical Data (Microscope Edit)

By using Microscope Edit, individual data events can be moved to a different location or edited in detail, and you can also delete or insert individual notes, etc. During step recording, you can switch to the Microscope page at any time.

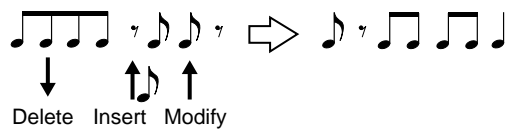

1. Move from the Step Recording page to the Microscope page.

While Recording in Step Recording 1 -> Press [REC].
 While Recording in Step Recording 2 -> Press [PLAY].
 You will enter the Microscope page, and the display will indicate the current input location (measure, beat, clock). This is referred to as the "position."

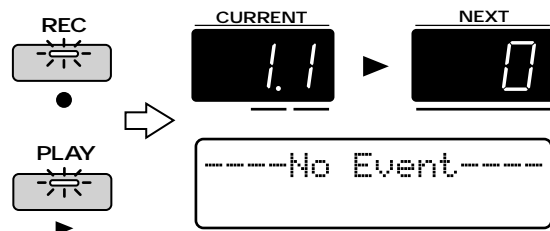

View the Musical Data That You Input

Rotate the [VALUE] dial to move the position to a location where musical data (notes and controller data, etc.) was input. The display will show the position and the type of musical data.

Rotating the [VALUE] clockwise will successively display the musical data that is located in the direction of the pattern playback.

Rotating the [VALUE] counterclockwise will successively display the musical data that is located in the opposite direction of the pattern playback.

You can also use [FWD] and [BWD] to step through the musical data instead of using the [VALUE] dial.

By holding down [SHIFT] and rotating the [VALUE] dial, you can move the position in units of one clock.

* If two or more MIDI messages exist at the same position, an "*" will appear in the upper left of the display.

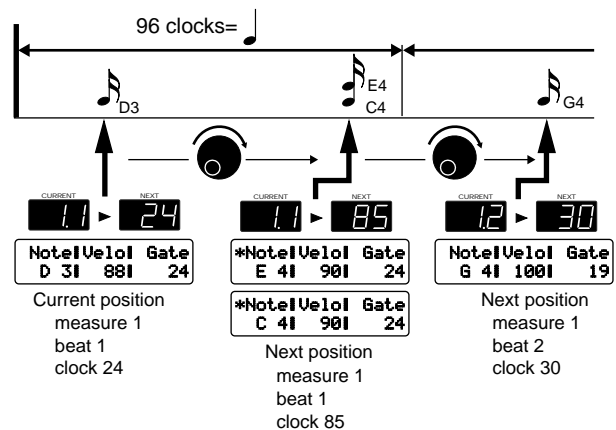

At this time you can press the PART button of another part to view the recorded data of that part or change the recording part. If you select the rhythm part, you can also select rhythm tones.

2. To return to recording mode,

To Return to Step Recording 1 -> Press [REC].

To Return to Step Recording 2 -> Press [PLAY].

In the case of Step Recording 1, recording will resume from the position to which you moved.

3. To exit the Microscope page, press [STOP].

If you wish to save the modified pattern, use the Pattern Write operation.

📖 "Saving Patterns You've Modified (Pattern Write)" (p. 26)

Musical Data Handled in Microscope Mode

The Microscope lets you view and edit the following 9 types of musical data (MIDI message).

Note

Data that plays a sound.

```
Note|Vel| Gate
D#2| 120| 96
```

Range:

Note: C-1-G9 (Note)

Velo: 1-127 (Velocity)

Gate: 1-21504 (Gate Time)

Control Change

These MIDI messages correspond to various control numbers, and are used apply effects such as modulation or portamento. These are used mainly to operate knobs and the part mixer.

```
CC#7 | Volume
Value= 127
```

Range:

CC#: 0-127 (Controller Number)

Value: 0-127

The upper right of the display will indicate the name of the function that corresponds to the controller number.



If you would like to know more about the function of each controller number...

☞ "Transmit/Receive Setting List" (p. 233)

Program Change

These MIDI messages are used to select sounds (patches).

The sound corresponding to the program number will be selected.

```
Program Change
PC#= 128
```

Range:

PC#: 1-128 (Program Number)

Pitch Bend

These MIDI messages change the pitch.

```
Pitch Bend
Value= 0
```

Range: -8192-+8191

Poly A-Touch (Polyphonic Aftertouch)

These MIDI messages apply aftertouch to individual notes.

```
Poly After| C#2
Value= 127
```

Range:

Note: C-1-G9 (Note)

Value: 0-127

The upper right of the display will indicate the note name.

Ch A-Touch (Channel Aftertouch)

These MIDI messages apply aftertouch to an entire MIDI channel.

```
Ch After
Value= 127
```

Range: 0-127

Tempo Change

This data controls the tempo. This is used only in the MUTE CTRL part.

```
Tempo Change
Value= 120.0
```

Range: 20.0-240.0

Mute

This is Mute data for each part and rhythm group. It is used only in the MUTE CTRL part.

```
Mute | TOM/PERC
Value= OFF
```

Range:

Part Group: R, P1-P7, BD, SD, HH, CLP, CYM, TOM/PERC, HIT, OTHERS

Value: OFF, ON

Sys Exclusive (System Exclusive)

These are MIDI messages unique to the MC-505. If the entire message cannot be shown on one line, a “

No Event

If there is no MIDI message at the current position, the following display will appear.



Modifying the Value of Musical Data (Change Event)

1. In the Microscope page, rotate the [VALUE] dial to select the musical data that you wish to change.

2. Press PAGE [>].

The cursor will appear below parameter values that can be modified.



3. Use [INC] [DEC] or the [VALUE] dial to modify the value.

4. Press [ENTER].

The normal display will reappear.

For messages that have more than one parameter value that can be modified (such as Notes, Control Changes, Polyphonic Aftertouch, etc.), use [ENTER] or PAGE [<] [>] to move the cursor.

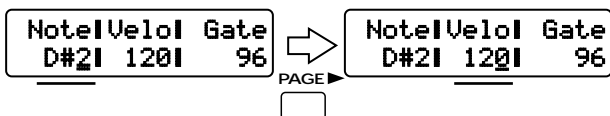

Modifying system exclusive data

System exclusive messages begin with F0, and end with F7. Data values are shown in hexadecimal notation (00–7F).

1. In the Microscope page, rotate the [VALUE] dial to select the system exclusive message that you wish to modify.

2. Press PAGE [>].

The system exclusive input page will appear, and the cursor will appear in the display.

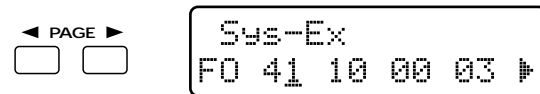

3. Press PAGE [<] [>] or [ENTER] to move the cursor to the location that you wish to modify.

4. Use [INC] [DEC] or the [VALUE] dial to modify the value.

At this time, you can use the keyboard pads to enter a hexadecimal number. The hexadecimal digit entered by each pad is as follows.

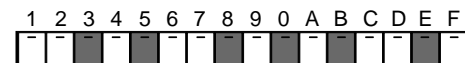

5. Move the cursor to the F7 location and press [ENTER], and the modified settings will be finalized.

When the settings have been finalized, you will return to the normal Microscope display.

* It is not possible to change the F0 that begins the message or the F7 that ends it.

* To add data, use the keyboard pads to input a value at the F7 location.

* By pressing [UNDO/REDO] you can delete the data at the cursor location.

To cancel the operation without changing the data, press [EXIT].

About the checksum

When inputting a Roland Type IV exclusive message, you must input a checksum immediately before the F7. Since the MC-505 will calculate the checksum automatically, there is no need for you to modify the checksum value. When you input a new exclusive message, you can simply input an arbitrary number immediately before F7, and the MC-505 will calculate the correct number automatically.

0

Deleting Musical Data (Delete Event)

1. In the Microscope display, rotate the [VALUE] dial to select the musical data that you wish to delete.
2. Press [EDIT].
The confirmation page will appear.

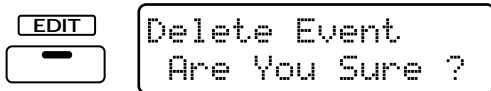

3. Press [ENTER].
The musical data will be deleted.

Inserting Musical Data (Insert Event)

1. In the Microscope display, rotate the [VALUE] dial to move to the position where you wish to insert musical data.
2. Press [WRITE].
The Insert Event page will appear, and the following display will appear.

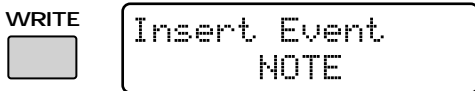

3. Use [INC] [DEC] or the [VALUE] dial to select the type of musical data that will be inserted.

Range:

When you are viewing a part R-7 in the Microscope

- NOTE: Note
- PC: Program change
- CC: Control change
- BEND: Pitch bend
- P-AFT: Polyphonic aftertouch
- C-AFT: Channel aftertouch

When you are viewing a MUTE CTRL part in the Microscope

- SYS-EX: System exclusive
- TEMPO: Tempo
- MUTE: Mute

4. Press [ENTER].
A message with basic settings for the selected type of musical data will appear.

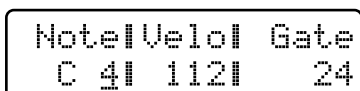

5. Press PAGE [<] [>] to move the cursor to the location that you wish to modify.
6. Use [INC] [DEC] or the [VALUE] dial to modify the value.
7. Press [ENTER] to finalize the settings.

.....
If you select "Sys Ex" (System Exclusive), the following message will appear. In the same way as for the Change Event operation, use the keyboard pads and [ENTER] to successively enter hexadecimal data.

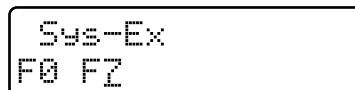

Using the keyboard pads and knobs to directly insert musical data

By holding down [WRITE] and pressing a keyboard pad, you can insert a Note message of a note name corresponding to the keyboard pad that you pressed. (Values are fixed at Velocity = 112, Gate Time = 24.)

By holding down the [WRITE] and operating a patch parameter knob, you can access the parameter of the knob that you operated.

While you hold down the button, the display will indicate the parameter that is being operated.

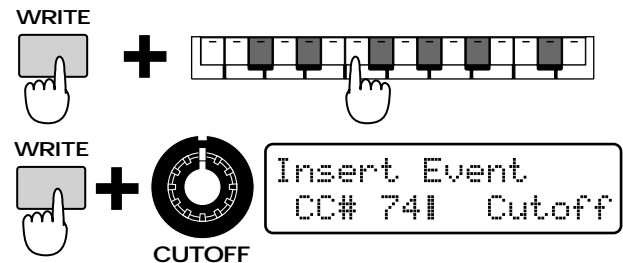

10

Moving Musical Data (Move Event)

1. In the Microscope page, rotate the [VALUE] dial to access the musical data that you wish to move.
2. Hold down [SHIFT] and [EDIT], and rotate the [VALUE] dial to move the data.
While you hold down the buttons, the display will indicate the position to which the data is being moved.

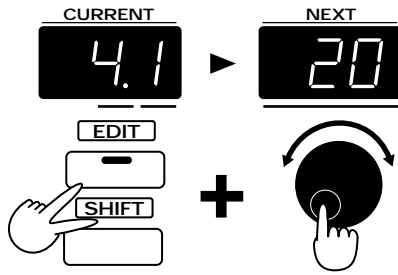

Hiding Unwanted Musical Data (View Filter)

If a large amount of musical data has been recorded in a pattern, it may be difficult for you to find the data you are looking for if all types of data are displayed. In such cases, you can use the View Filter to specify the types of musical data that will be displayed. Since you can specify that only certain MIDI messages will be displayed, this lets you rapidly find the data that you are looking for.

1. In the Microscope page, press [MEASURE]. The View Filter page will appear in the display.

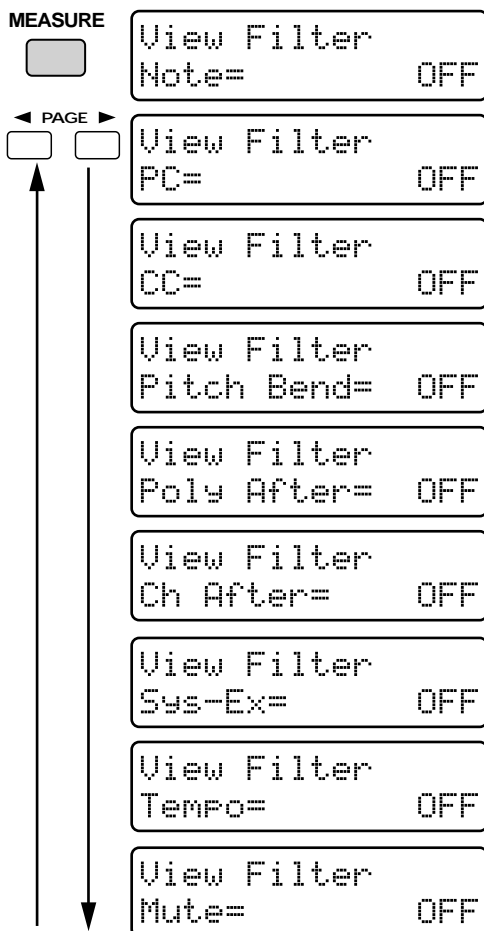

2. Press PAGE [<] [>] to select the type of musical data.

NOTE: Note
 PC: Program change
 CC: Control change
 Pitch Bend: Pitch bend
 Poly After: Polyphonic aftertouch
 Ch After: Channel aftertouch
 Sys-Ex: System exclusive
 Tempo: Tempo
 MUTE: Mute

3. Use [INC] [DEC] or the [VALUE] dial to turn off the display of musical data that you do not need to view.

4. When you finish making settings, press [EXIT] to exit the page.

Data that you turned off will no longer be displayed in the Microscope page.

Checking the Remaining Amount of Memory (Memory Information)

Here's how you can check the amount of memory remaining in the pattern/song temporary area, in user memory, and in card memory.

1. Hold down [SHIFT] and press keyboard pad [14].

The Memory Information page will appear.

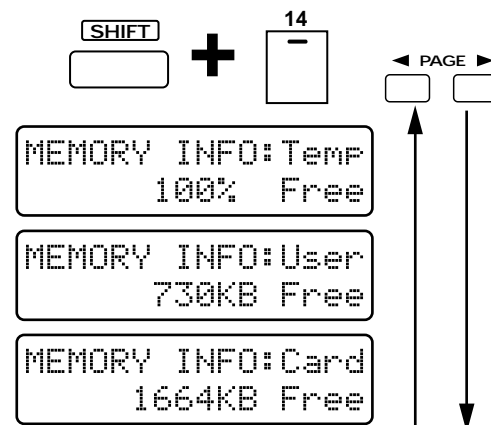

2. Use PAGE [<] [>] to switch pages within the section.
3. To exit this display, press [EXIT].

Temp (Temporary)

The remaining amount of musical data that can be recorded in the pattern currently loaded into the temporary area is displayed as a percentage.

If the remaining amount reaches "0%," no further recording or pattern editing is possible.

User (User Memory)

The remaining amount of internal user memory is displayed in KB (kilobytes). The maximum capacity of the user memory is approximately 95,000 notes (the capacity when all songs are EMPTY SONG).

Card (Card Memory)

The remaining amount of memory in the card is displayed in KB (kilobytes).

** If the remaining amount is "0 KB" or if the size of the pattern that you wish to save (the amount of data in the pattern loaded into the temporary area) is larger than the remaining capacity of user memory or card memory, it will not be possible to save that pattern. Also, if the remaining capacity of card memory is 1030 KB or less, it will not be possible to create a backup file.*

 ["Saving All Internal Settings to a Card \(User Backup\)" \(p. 160\)](#)

About KB (kilobytes)

KB is a unit for measuring data size. Approximately 120 notes can be recorded using 1 KB.

1000 KB is also expressed as 1 MB (megabyte).

Maximum number of recorded notes

A maximum of approximately 8,000 notes of musical data can be recorded in the temporary pattern. This is the maximum number of notes that can be recorded in a single pattern. The MC-505 is not able to record or edit a pattern that is larger than this.

About the number of patterns that can be saved

A maximum of 200 patterns that you create can be saved in user memory, and a maximum of 200 can be saved in card memory. This number will depend on the amount of data in the patterns that you create. For example, if you create many patterns containing large amounts of data, so there is no remaining capacity in user memory or card memory, no further patterns can be saved. Also, if the size of the pattern (the amount of data occupied by the pattern in the temporary area) is greater than the remaining amount of user memory or card memory, that pattern cannot be saved.

When you begin to approach the limits of user memory or card memory, you can increase the amount of space available by initializing unwanted patterns, etc.



If you wish to initialize a pattern...

["Copying and Initializing Settings" \(p. 27\)](#)

Chapter 11. Editing Patterns (Pattern Edit)

The process of editing the musical data in a pattern is called Pattern Editing. You can modify the content of the musical data in a pattern, or combine various patterns to create an entirely different pattern.

* *The edited pattern is kept in the temporary pattern (U:TMP). If you wish to keep the pattern that you created, you must use the Pattern Write operation.*

 **“Saving Patterns You've Modified (Pattern Write)” (p. 26)**

Cautions when editing a pattern

A pattern can be edited when the Pattern Select page of Pattern mode is displayed (i.e., when the [PTN/SONG] indicator is lit). It is not possible to enter the various editing pages while the pattern is playing back.

Setting parameters

To use or modify the parameters, use [INC] [DEC] or the [VALUE] dial.

Selecting the part

To select the part you wish to edit, press the appropriate PART button. The part whose indicator is lit will be selected for editing.

If during editing you wish to return to the previous parameter setting page, press PAGE [<].

If you wish to cancel your edits, press [EXIT].

Undo/Redo

If you are not happy with the edited pattern, you can press the [UNDO/REDO] button to return the musical data to the un-edited state.

* *In some cases, such as when a very large amount of data was processed, the Undo operation may not be available.*

 **“Canceling the Previous Operation (Undo/Redo)” (p. 18)**

Copying a Portion of a Pattern (Copy)

A specific portion of a pattern can be copied to another pattern. This is convenient when you wish to combine portions of various patterns to create a new pattern.

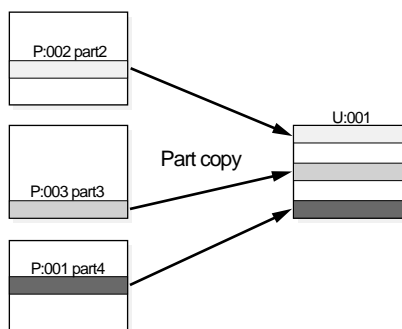

* *If the copy source pattern has more measures than the copy destination pattern, the number of measures in the copy destination pattern may increase.*

* *It is not possible to copy between patterns that have different time signatures.*

* *If you wish to move (copy) a specific pattern (without modifying it) to a user pattern, use the Pattern Write operation to move the data.*

1. Select the copy source pattern.

2. Hold down [EDIT] and press keyboard pad [1].

The copy setting page will appear.

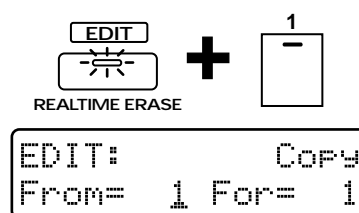

3. Select the part that you wish to copy.

* *You can select more than one part simultaneously.*

4. Specify the measure at which copying will begin.

Range: 1–32

5. Press [ENTER].

The cursor will move to the right.

6. Specify the measure length (number of measures) to be copied.

Range: 1–32, ALL

* *If the setting is “ALL,” the measure at which copying began and all subsequent measures will be copied.*

For example, if you wish to copy from measure 4 to the end of measure 6, make settings as follows.

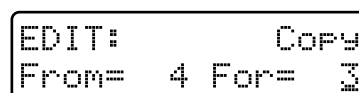

7. Press [ENTER].

The display will indicate the bank and number of the copy destination pattern.

8. Select the copy destination pattern.

Range: P:001–P:714, U:001–U:200, C:001–C:200

* You can switch banks by pressing [PRESET]/ [USER]/ [CARD].

```
EDIT:          Copy
Dest PTN=     U:001
```

9. Select the copy destination part.

* If more than one part was selected as the copy source, the data will automatically be copied to the same parts as the copy source.

* If [MUTE CTRL] was selected as the copy source part, only [MUTE CTRL] can be selected as the copy destination part.

10. Press [ENTER].

The display will indicate the copy start measure of the copy destination part.

11. Specify the copy start measure of the copy destination part.

Range: 1–32, END

* If the setting is "END," the data will be copied onto the end of the copy destination part.

* It is not possible to specify a measure number that would cause the length of the pattern to exceed 32 measures.

```
EDIT:          Copy
Dest Mes=     END
```

12. Press [ENTER].

The display will indicate the type of musical data to be copied.

13. Select the type of musical data that you wish to copy.

```
EDIT:          Copy
Status=       ALL
```

Range:

ALL: All musical data

NOTE: Note

PC: Program change

CC: Control change

BEND: Pitch bend

P-AFT: Polyphonic aftertouch

C-AFT: Channel aftertouch

SYS-EX: System exclusive

TEMPO: Tempo

MUTE: Mute

14. Press [ENTER].

The display will show the Copy Mode setting.

15. Select the copy mode.

```
EDIT:          Copy
Mode=         REPLACE
```

Range: REPLACE, MIX

REPLACE: Musical data in the copy destination will be erased (i.e., overwritten) when the copy takes place.

MIX: Musical data in the copy destination will be combined with the newly copied data.

16. Press [ENTER].

The display will let you specify the number of times that the data will be copied.

17. Specify the number of times that the data will be copied.

```
EDIT:          Copy
Times=         1
```

Range: 1–32

* It is not possible to specify a number of measures that would cause the length of the pattern to exceed 32 measures when the Copy was executed.

18. Press [ENTER].

The confirmation page will appear.

```
EDIT:          Copy
Are You Sure ?
```

19. Press [ENTER] once again.

The copy operation will be carried out, and the normal display will reappear.

Erasing Unwanted Data (Erase)

This operation erases part of the pattern. This operation is useful when you wish to erase data that was input by mistake.

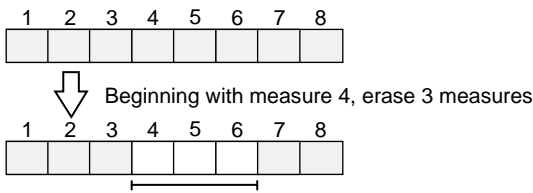

* Erasing data will not affect the length of the pattern.

1. Select the pattern from which you wish to erase data.
2. Hold down [EDIT] and press keyboard pad [2].

The Erase page will appear in the display.

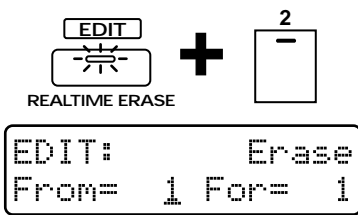

3. Select the part from which you wish to erase data.

* You can select more than one part.

4. Specify the measure at which erasure will begin.

Range: 1–32

5. Press [ENTER].

The cursor will move to the right.

6. Specify the measure length (number of measures) from which data will be erased.

Range: 1–32, ALL

* If this is set to "ALL," the specified starting measure and all subsequent measures will be affected by the operation.

For example, if you wish to erase from measure 4 to the end of measure 6, make settings as follows.

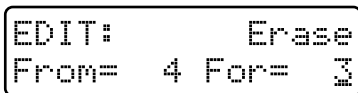

7. Press [ENTER].

The display will indicate the type of musical data that will be erased.

8. Select the type of musical data that you wish to erase.

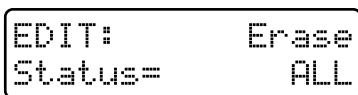

Range:

ALL: All musical data

- NOTE: Note
 PC: Program change
 CC: Control change
 BEND: Pitch bend
 P-AFT: Polyphonic aftertouch
 C-AFT: Channel aftertouch
 SYS-EX: System exclusive
 TEMPO: Tempo
 MUTE: Mute

.....
 If NOTE is selected as the type of musical data, and you wish to erase only a specific range of notes, you can press the keyboard pad to specify the range. For example, if you specify the range as follows, notes from D4 to G4 will be erased. If you do not specify the note range, all notes will be erased.

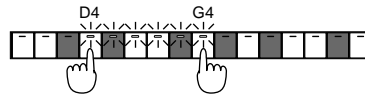

9. Press [ENTER].

The confirmation screen will appear in the display.

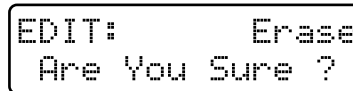

10. Press [ENTER] once again.

The Erase operation will be carried out, and the normal display will reappear.

Deleting Unwanted Measures (Delete Measure)

This operation deletes unwanted measures from a pattern, and moves any subsequent measures toward the beginning to close the gap. If there is data later than the area that was deleted, the musical data of that part will become shorter. If all parts were specified for the delete operation, the pattern itself will become shorter.

* If you delete all measures of all parts, the pattern itself will be deleted, and will be a pattern containing no musical data (an empty pattern).

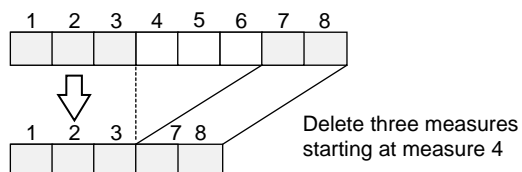

1. Select the pattern from which you wish to delete data.

2. Hold down [EDIT] and press keyboard pad [3].

The Delete Measure setting page will appear.

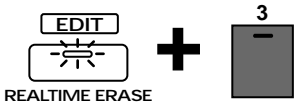

```
EDIT: Delete Mes
From= 1 For= 1
```

3. Select the part from which you wish to delete data.

* You can select more than one part.

4. Specify the measure at which deletion will begin.

Range: 1–32

5. Press [ENTER].

The cursor will move to the right.

6. Specify the measure length (number of measures) that will be deleted.

Range: 1–32, ALL

* If the setting is "ALL," the measure at which deletion began and all subsequent measures will be affected by the operation.

For example, if you wish to delete from measure 4 to the end of measure 6, make settings as follows.

```
EDIT: Delete Mes
From= 4 For= 3
```

7. Press [ENTER].

The confirmation screen will appear in the display.

```
EDIT: Delete Mes
Are You Sure ?
```

8. Press [ENTER] once again.

The Delete Measure operation will be carried out, and the normal display will reappear.

Inserting Blank Measures (Insert Measure)

This operation inserts blank measures into the specified location of a pattern. If you wish to add more musical material in the middle of a pattern, use this operation to insert blank measures before recording the additional material.

The inserted measures will have the same time signature as the pattern.

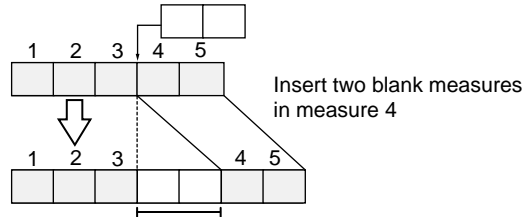

* It is not possible to make settings that would make the pattern length exceed 32 measures.

1. Select the pattern into which measures will be inserted.

2. Hold down [EDIT] and press keyboard pad [4].

The display will show the Insert Measure setting page.

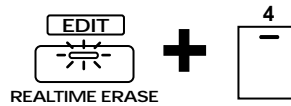

```
EDIT: Insert Mes
From= 1 For= 1
```

3. Select the part into which you wish to insert measures.

* You may select more than one part.

4. Specify the measure at which the blank measures will be inserted.

Range: 0–31, END

* If you specify "END," the blank measures will be added to the end of the musical data.

5. Press [ENTER].

The cursor will move to the right.

6. Specify the measure length (number of measures) that will be inserted.

Range: 0–31

For example, if you wish to insert two blank measures between measures 3 and 4, make the following settings.

```
EDIT: Insert Mes
From= 4 For= 2
```

7. Press [ENTER].

The confirmation screen will appear in the display.

```
EDIT: Insert Mes
Are You Sure ?
```

8. Press [ENTER] once again.

The Insert Measure operation will be carried out, and the normal display will reappear.

Transposing the Pitch (Transpose)

This operation shifts the note numbers (pitch) of the data recorded in a pattern. You can specify a transposition of up to +/-2 octaves.

* It is not possible to specify the range of measures that will be transposed.

Transpose four semitones upward (+4)

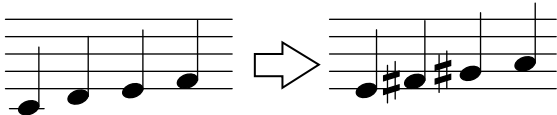

1. Select the pattern that you wish to transpose.
2. Hold down [EDIT] and press keyboard pad [5].

The display will show the Transpose setting page.

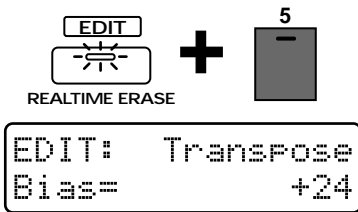

3. Select the part that you wish to transpose.
4. Specify the amount of transposition, in semitone steps.

Range: -24--+24

* If the setting value is "0," no transposition will occur.

1 If you wish to transpose only a specific range of notes, press the keyboard pad to specify the desired range. If you do not specify the note range, all notes will be transposed.

5. Press [ENTER].

The confirmation screen will appear in the display.

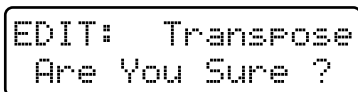

6. Press [ENTER] once again.

The Transpose operation will be carried out, and the normal display will reappear.

Modifying the Strength of Notes (Change Velocity)

This operation modifies the velocity (playing strength) of the notes recorded in the pattern. Increasing the velocity values will cause the notes to be played more strongly. This operation can be used to increase or decrease the overall keyboard playing dynamics.

* If this operation would result in a velocity greater than 127 (or less than 1), the result will be limited to 127 (or 1).

* It is not possible to specify the range of measures in which velocity will be modified.

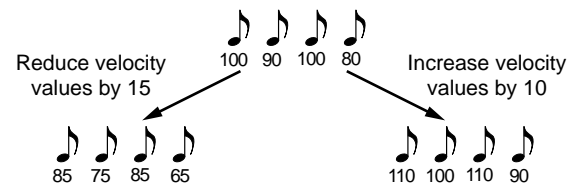

1. Select the pattern in which you wish to modify the velocity.

2. Hold down [EDIT] and press keyboard pad [6].

The display will show the Change Velocity setting page.

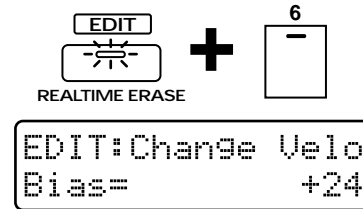

3. Select the part whose velocity you wish to change.

* You may select more than one part.

4. Specify the amount that will be added to (or subtracted from) the velocity.

Range: -99--+99

If this value is "0," the velocity will not be modified.

If you wish to modify the velocity of a specific range of notes, use the keyboard pads to specify the range. If you do not specify the note range, the velocity of all notes will be modified.

5. Press [ENTER].

The confirmation screen will appear in the display.

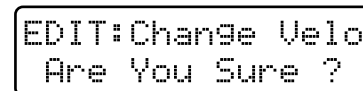

6. Press [ENTER] once again.

The Change Velocity operation will be carried out, and the normal display will reappear.

Modifying the Note Length (Change Gate Time)

This operation modifies the gate time (duration) of the notes recorded in the pattern. This can be used to make the overall performance more staccato or tenuto.

* If this operation would result in a gate time longer than 21504 (or shorter than 1), the result will be limited to 21504 (or 1).

* It is not possible to specify the range of measures that will be modified by this operation.

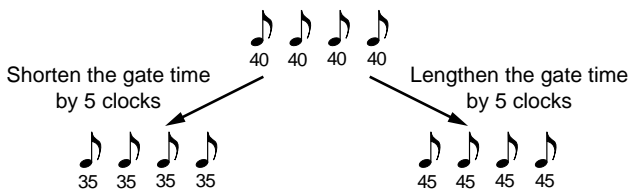

1. Select the pattern in which you wish to modify the gate time.

2. Hold down [EDIT] and press keyboard pad [7].

The display will show the Change Gate Time setting page.

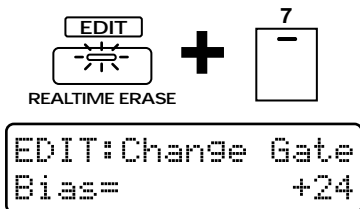

3. Select the part in which you wish to modify the gate time.

* You may select more than one part.

4. Specify the amount that you wish to add to (or subtract from) the gate time.

Range: -99+99

With a setting of "0," the gate time will not be modified.

.....
 If you wish to modify the gate time of a specific range of notes, you can use the keyboard pads to specify the range. If you do not specify the range of notes, the gate time of all notes will be modified.

5. Press [ENTER].

The confirmation screen will appear in the display.

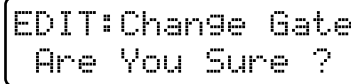

6. Press [ENTER] once again.

The Change Gate Time operation will be carried out, and the normal display will reappear.

Shifting the Timing Slightly (Shift Clock)

Using this operation, the timing of the musical data in a pattern can be shifted forward or backward in time, in units of a single clock. Use this when you wish to slightly shift the overall timing.

* Data which would otherwise be moved earlier than the beginning of the music data will be placed at the beginning. In the case of data which would be moved later than the end of the music data, the necessary number of measures will be added. However if the data would otherwise be moved beyond the end of the pattern, it will be placed at the end.

* It is not possible to specify the range of measures that will have their timing shifted.

* 24 clocks correspond to the length of one 16th note.

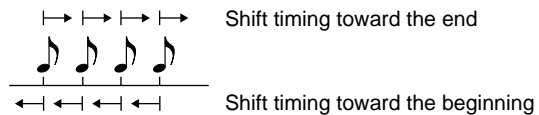

1. Select the pattern whose timing you wish to shift.

2. Hold down [EDIT] and press keyboard pad [8].

The Shift Clock setting page will appear in the display.



3. Select the part whose timing you wish to shift.

* You may select more than one part.

4. Specify the number of clocks that you wish to shift the data.

Range: -99+99

Specify a negative (-) setting if you wish to shift the data toward the beginning. Specify a positive (+) set-

ting if you wish to shift the data toward the end.
If this is set to "0" the data will not be shifted.

5. Press [ENTER].

The display will indicate the type of musical data that will be shifted.

6. Select the type of musical data that you wish to shift.



Range:

- ALL:** All musical data
- NOTE:** Note
- PC:** Program change
- CC:** Control change
- BEND:** Pitch bend
- P-AFT:** Polyphonic aftertouch
- C-AFT:** Channel aftertouch
- SYS-EX:** System exclusive
- TEMPO:** Tempo
- MUTE:** Mute

NOTE is selected as the type of musical data, and if you wish to shift only a specific range of notes, use the keyboard pads to specify the desired range. If you do not specify a range of notes, all notes will be shifted.

7. Press [ENTER].

The confirmation screen will appear in the display.

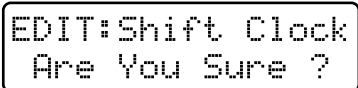

1

8. Press [ENTER] once again.

The Shift Clock operation will be carried out, and the normal display will reappear.

Thinning Out Unneeded Data (Data Thin)

Since messages such as pitch bend or control change use continuously changing values, they can occupy an unexpectedly large amount of memory. The Data Thin operation lets you thin out such data in a way that will not affect the audible result, yet will reduce the amount of data.

** It is not possible to specify the range of measures affected by this operation.*

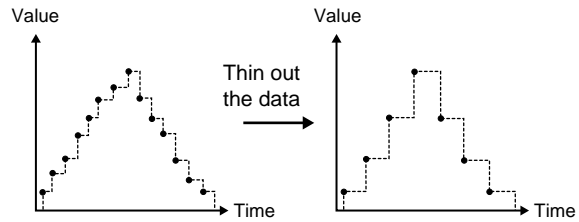

1. Select the pattern in which you wish to thin data.

2. Hold down [EDIT] and press keyboard pad [9].

The Data Thin setting page will appear in the display.

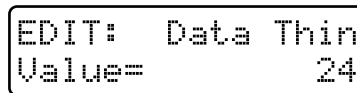
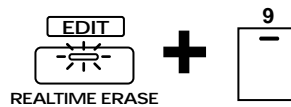

2. Select the part whose data will be thinned.

** You may select more than one part.*

3. Specify the amount of data to be thinned.

Range: 0-99

Higher settings will cause more data to be thinned. If the setting is "0," the data will not be thinned.

4. Press [ENTER].

The display will indicate the type of musical data that is to be thinned.

5. Select the type of musical data that you wish to thin.

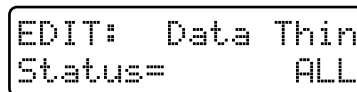

Range:

- ALL:** All of the following musical data
- CC:** Control change
- BEND:** Pitch bend
- P-AFT:** Polyphonic aftertouch
- C-AFT:** Channel aftertouch

6. Press [ENTER].

The confirmation screen will appear in the display.

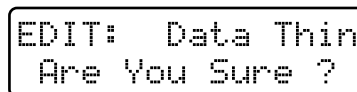

7. Press [ENTER] once again.

The Data Thin operation will be carried out, and the normal display will reappear.

Using Play Quantize Settings to Modify a Pattern (Edit Quantize)

You can modify the musical data of a pattern according to the Play Quantize settings.

Normally, Play Quantize does not affect the contents of the musical data, but only modifies the timing at which the pattern is played back. By using Edit Quantize, you can modify the musical data itself, so the data will play back with the same groove even if you do not apply Play Quantize.

* It is not possible to specify the area of measures in which the musical data will be modified.

1. Select the pattern whose data you wish to modify.
2. Play back the pattern, apply Play Quantize, and adjust the groove as desired.
3. Press [STOP] to stop the pattern.
4. Hold down [EDIT] and press keyboard pad [10].

The Edit Quantize setting page will appear in the display.

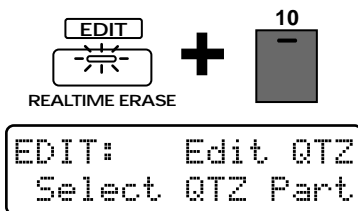

5. Select the part (s) for which you wish to carry out Edit Quantize.

* You may select more than one part.

* The indicators will already be lit for the parts to which Play Quantize had been applied (the parts selected by [QUANTIZE SELECT]). If you wish to apply the operation to these same parts, you may simply continue to the next step.

6. Press [ENTER].

The confirmation screen will appear in the display.

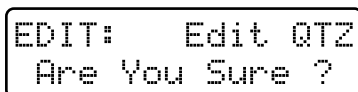

7. Press [ENTER] once again.

The Edit Quantize operation will be carried out, and the normal display will reappear. When the operation is completed, Play Quantize will automatically be turned off.

Converting the Note Timing of a Pattern (Reclock)

You can double or halve the timing of the musical data recorded in a pattern. For example, you can convert a four-measure pattern of tempo=120 to two measures so it will play back identically at a tempo of 60. When you wish to connect patterns of radically differing tempo, it is a good idea to use the Reclock operation to match the timing values of the two patterns.

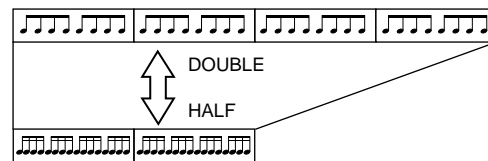

* Executing the Reclock operation will not affect the original tempo of the pattern.

1. Select the pattern whose timing values you wish to convert.
2. Hold down [EDIT] and press keyboard pad [11].

The Reclock setting page will appear in the display.

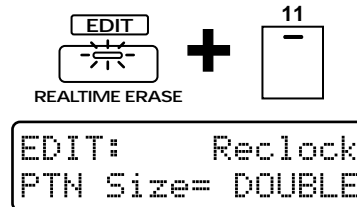

3. Select the part whose timing values you wish to convert.

* You may select more than one part.

4. Specify how the timing values will be converted.

Range:

HALF: Timing values will be halved

DOUBLE: Timing values will be doubled

* It will not be possible to make parameter settings for which the Reclock operation would make the length of the pattern exceed 32 measures or be shorter than 1 measure.

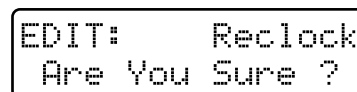

5. Press [ENTER].

The Reclock operation will be carried out, and the normal display will reappear.

Chapter 12. Playing and Recording Songs

A set of patterns that are connected in the order of playback is called a “song.”

When you play back a song, the patterns will change automatically in sequence, so it will not be necessary for you to select patterns yourself. You can register up to 50 patterns in each song, in the order in which they are to be played back.

Playing Back a Song

1. Press [MODE] to make the SONG indicator light (Song mode).

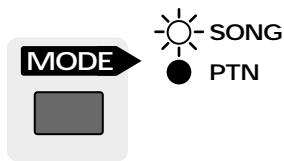

2. Press [PTN/SONG].

The indicator will light.

The display will show the bank, number and name of the currently selected song.

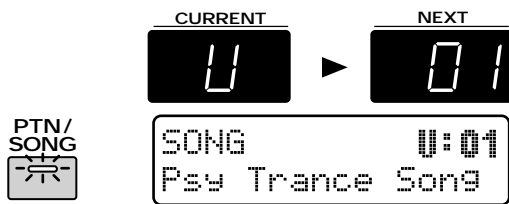

3. Press [USER] to select the user bank.

* For songs, it is not possible to select the preset bank or card bank.

4. Use [INC] [DEC] or the [VALUE] dial to select a number (01D50).

The number and name shown in the display will change.

The song is now selected.

* With the factory settings, U:21–U:50 will be blank songs (EMPTY SONG) that contain no musical data. Even if you select EMPTY SONG and then play back, no song will play back.

5. Press [PLAY], and the song will begin playing back.

When song playback begins, the display will indicate the current pattern and the next pattern, just as during pattern playback. Also, the name of the current pattern is displayed in the lower part of the LCD.

As playback continues, the patterns will switch automatically in the recorded sequence. Tempo changes and the measure display within the pattern can be

controlled in the same way as when playing back a pattern (p. 20).

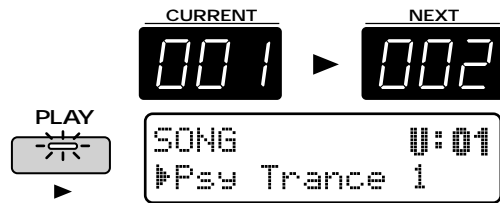

6. Press [STOP], and song playback will stop.

* It is not possible for you to select patterns yourself. Nor is it possible to switch songs during playback.

Fast-forward and rewind

Each time you press [FWD], you will fast-forward in units of a pattern.

Each time you press [BWD], you will rewind in units of a pattern.

By holding down [SHIFT] and pressing [FWD], you can advance to the beginning of the last pattern.

By holding down [SHIFT] and pressing [BWD], you can return to the beginning of the song. Also, you can press [STOP] while the song is stopped to return to the beginning.

If you use [FWD] and [BWD] to move while the song is stopped, the CURRENT display will show the playback order of that pattern. In the following example, the display shows that pattern P:002 will be played back second.

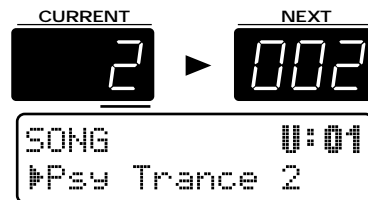

If you wish to return to the song select page, press [EXIT] or [PTN/SONG].

Cautions for song playback

Songs do not actually contain the musical data of the patterns; they contain only the order in which the patterns are to be played back. This means that if you modify a pattern that has been registered in a song, the playback of the song will also be affected. If you delete all of the musical data of the pattern, playback will stop at the moment that that pattern is selected.

If a song uses patterns that are saved in a memory card, song playback will stop if the memory card is not inserted into the memory card slot. Be sure that the memory card is inserted into the memory card slot.

Recording a Song

On the MC-505, you can record a song by inputting the order in which patterns will be played back.

1. Select the song that you wish to record.
2. Press [REC].

The indicator will light, and recording will begin.

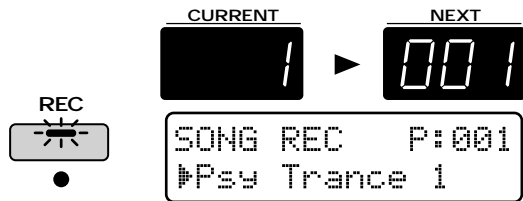

The CURRENT display will show the pattern input number (the order of playback).

If you have selected a new song and begun recording, this will be "1."

3. Use [INC] [DEC] or the [VALUE] dial to select the pattern that will be registered first.
4. Press [ENTER].
5. Select the pattern that will be registered next.

After making your selection, press [ENTER].

6. Repeat step 3, 4 to complete the song.

When you have finalized the last pattern, press [STOP] to end recording.

If you input a pattern by mistake, hold down [SHIFT] and press [BWD] to return to the input page for the previous step.

Re-recording from the middle

If you are re-recording a song from the middle, or when you wish to add a new pattern to the end of a song, use [FWD] to advance to the location (pattern input number) where you wish to begin recording. Then you can enter recording mode to re-record from that location.

Auditioning a pattern

After selecting a pattern during recording, you can press [PLAY] to audition that pattern. As in Pattern mode, you can select different patterns while you audition them. When you are finished auditioning, press [STOP].

Assigning a pattern with modified Setup parameters

While auditioning a pattern, you can modify the mute, part mixer and effect settings, etc. for that part and press [ENTER] to assign the part with those settings. This will not affect the original pattern in any way, since the setup parameters for each pattern are stored as part of the song data.

Using this function, you can modify the mute settings or EFX type of one single pattern and create a song just by developing the same pattern in different ways.

Saving a Song That You Recorded (Song Write)

If you are happy with the song that you recorded, you can save that song as a user song.

1. Make sure that the song is stopped.
2. Press [PTN/SONG] to access the song select page.

If you modify song settings, an "*" (asterisk) will appear at the left of the number, indicating that the selected song has been modified (edited). Be aware that if you turn off the power without saving the modified song, the previous settings will reappear.

3. Press [WRITE].

The following display will appear, and a "_" (cursor) will appear below the number.



If you do not wish to modify the number or name, you can skip steps 4–8.

If you decide not to save the song, press [EXIT].

4. Select the save destination song.

When saving a song, only the user bank can be selected.

5. Use [INC] [DEC] or the [VALUE] dial to select the save destination number.

.....
At this time, you can press [UNDO/REDO] to check the name of the song that is currently in the save destination number. After you have found a song that you do not mind overwriting, press [UNDO/REDO] once again to return to the previous display.
.....

6. Press PAGE [>].

The cursor will move to the beginning of the second line of the display.

```
SONG-Write  U:02  
Psy Trance Song
```

7. Assign a name to the song.

Use [INC] [DEC] or the [VALUE] dial to specify characters.

The following characters can be selected.

Space, A-Z, a-z, 0-9, ! " # \$ % & ' () * + , - . / : ; < = > ?
@[¥]^_`{|}

8. Repeat steps 6&7 to enter the name.

To move the cursor back toward the left, press PAGE [<].

9. Press [ENTER].

The confirmation screen will appear in the display.

```
SONG-Write  U:02  
Are You Sure ?
```

10. Press [ENTER] once again.

```
Processing...  
Keep Power ON !
```

The Song Write operation will be carried out, and the normal display will reappear.
The song has now been saved.

Chapter 13. Editing Songs (Song Edit)

In the same way that you edited a pattern in Pattern mode, you can edit a song in Song mode. The process of making changes in Song mode is called “song editing.”

* An edited song is held in the temporary area. If you wish to keep the song that you created, you must perform the Song Write operation.

 **“Saving a Song That You Recorded (Song Write)”** (p. 155)

Cautions for song editing

Song editing can be performed when the song select page of Song mode is displayed (i.e., when the [PTN/SONG] indicator is lit). It is not possible to enter the various editing pages during song playback.

Setting the parameters

To set or modify each parameter, use [INC] [DEC] or the [VALUE] dial.

You can also use [FWD] [BWD] to specify the location at which you will begin editing (the pattern playback number).

During editing, if you wish to return to the previous parameter setting page, press PAGE [←].

If you wish to cancel your editing, press [EXIT].

Copying a Song (Song Copy)

This operation copies a song to a specified location in a different song. This can be used to combine two songs into a single song, or to combine parts of various songs to create a different song.

* If there is already data in the copy destination song, the song data of the copy destination will be rewritten.

The number of patterns in the copy destination song may increase, such as when the copy source song contains more patterns than the copy destination song.

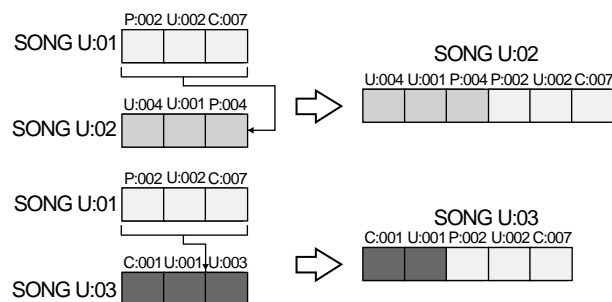

1. Select the copy source song.

2. Hold down [EDIT] and press keyboard pad [1].

The Song Copy setting page will appear in the display.



3. Select the copy destination song.

Range: U:01–U:50

4. Press [ENTER].

The display will indicate the pattern playback number of the copy destination song and the corresponding pattern.

5. Specify the location (pattern playback number) at which copying will begin.

Range: 1–50, END

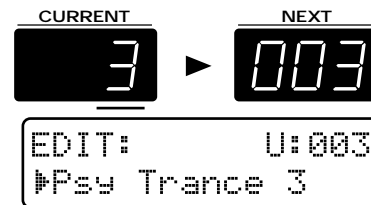

If the setting is “END,” the data will be copied onto the end of the copy destination song.

* It is not possible to specify a Copy operation that would result in a song containing more than 50 patterns.

6. Press [ENTER].

The confirmation screen will appear in the display.

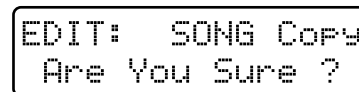

7. Press [ENTER] once again.

The Song Copy operation will be carried out, and the normal display will reappear.

Deleting Unwanted Patterns from a Song (Delete Pattern)

This operation deletes a pattern from a song. When a pattern is deleted, subsequent patterns will be moved forward. Use this when you wish to remove unwanted patterns from a song.

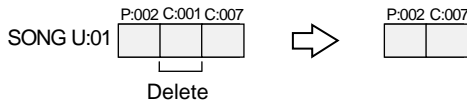

1. Select the song from which you wish to delete a pattern.
2. Hold down [EDIT] and press keyboard pad [3].

The Delete Pattern setting page will appear, and the display will indicate the pattern playback number and the corresponding pattern.

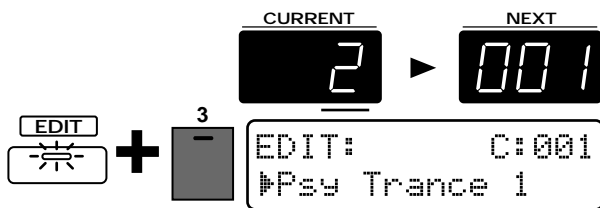

3. Select the pattern (pattern playback number) that you wish to delete.
Range: 1–50, ALL

With a setting of “ALL,” all patterns in the song will be deleted (Song Initialize).

4. Press [ENTER].
The confirmation screen will appear in the display.

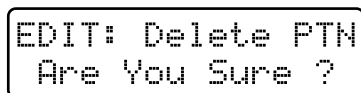

5. Press [ENTER] once again.
The Delete Pattern operation will be carried out, and the normal display will reappear.

Inserting a Pattern (Insert Pattern)

This operation insert a pattern into the specified location of a song. Use this when you want to add additional patterns to the song.

* A maximum of 50 patterns can be recorded in a song. If the song already contains 50 patterns, no more patterns can be inserted.

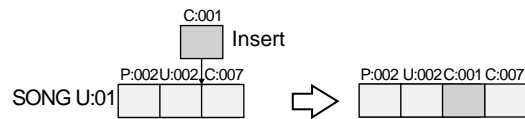

1. Select the song into which you wish to insert a pattern.
2. Hold down [EDIT] and press keyboard pad [4].

The Insert Pattern setting page will appear, and the display will indicate the pattern playback number and the corresponding pattern.

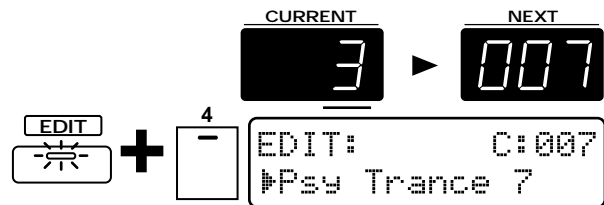

3. Specify the location (pattern playback number) at which the pattern will be inserted.

Range: 1–49, END

With a setting of END, the pattern will be added to the end of the song.

4. Press [ENTER].
The display will now allow you to select the pattern that will be inserted.

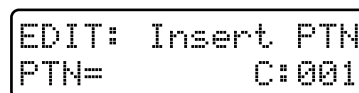

5. Select the pattern that will be inserted.
Range: P:001–P:714, U:001–U:200, C:001–C:200

* You can press [PRESET], [USER] or [CARD] to switch banks.

6. Press [ENTER].
The confirmation screen will appear in the display.

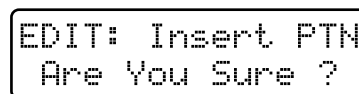

7. Press [ENTER] once again.
The Insert Pattern operation will be carried out, and the normal display will reappear.

Chapter 14. Using Memory Cards

How a Memory Card Can Be Used

The rear panel of the MC-505 has a memory card slot that allows you to use memory cards (SmartMedia : optional). Memory cards can be used in the following ways.

- 1) In addition to the User banks in internal memory, you will be able to use Card banks to store user patches and user patterns.

Patches: C:A001–C:D128, C:01–C:20 (p. 23)

Patterns: C:001–C:200 (p. 19)

Patches and patterns that are stored in a card bank can be used in the same way as patches and patterns from the user bank.

- 2) All settings of the MC-505 including System settings can be saved (backed up) to a card, and restored into internal memory (Backup Load) when desired.

* Except while performing the Card Duplicate operation (p. 161), be sure to turn off the power before inserting or removing a card.

* If a write protect sticker is affixed to the write protect area of the memory card, it will no longer be possible to record or erase the data of that card. When saving/initializing a pattern or patch, be sure that the write protect sticker does not remain on the card. For details on the write protect sticker, refer to the owner's manual for your memory card.

If you attempt to carry out an operation such as saving to the card bank, the following message will appear.

CAUTION !
Memory Protected

Memory Cards the MC-505 Can Use

The MC-505 can use the following memory cards (sold separately). Memory cards other than those specified should not be inserted into the memory card slot.

S2M-5 (2 MB type)

S4M-5 (4 MB type)

2 MB and 4 MB cards differ in the maximum number of patterns that they can store.

2 MB: Maximum 220,000 notes

(100,000 notes if there is a backup file)

4 MB: Maximum 480,000 notes

(360,000 notes if there is a backup file)

Inserting and Removing a Card

Except when performing the Card Duplicate operation, be sure that the power is turned off when you insert or remove a card.

1. With the power turned off, insert the memory card into the rear panel memory card slot as shown in the diagram. Push the card firmly all the way into the slot.

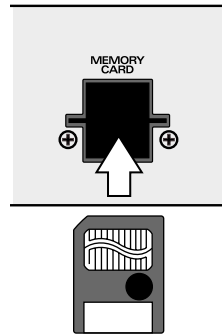

Before Using a New Card (Format)

Before a newly purchased memory card can be used by the MC-505, you must use the "Format" operation to prepare it for use with the MC-505. When a memory card is formatted, all data that was on the card will be erased. This means that you can also use the Format operation to erase a card that has already been used on the MC-505.

When an unformatted card is inserted, the following display will appear.

CAUTION !
Wrong Card

1. Make sure that the memory card you wish to format is inserted into the memory card slot.
2. Hold down [SHIFT] and press keyboard pad [15].

This takes you to the screen for formatting cards.

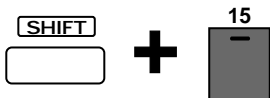

```
CARD:      Format
Are You Sure ?
```

3. Press [ENTER].

The following display will appear, and the Format operation will be carried out.

```
Processing...
Keep Power ON !
```

4. When formatting ends, the following display will appear.

```
CARD:      Format
Complete !
```

To exit the setting page, press [EXIT].

Saving All Internal Settings to a Card (User Backup)

All internal data (user patches, user patterns, user songs, user pattern sets, user RPS sets etc.) and system settings can be saved as a whole to a memory card. This data is collectively known as a “backup file.” Each memory card can contain one such backup file.

** In order to create a backup file, there must be at least 1030 KB of remaining card memory. If you attempt to make a user backup when there is less than 1030 KB of remaining memory in the card, the following message will appear. If this happens, initialized unneeded patterns to increase the free card memory to 1030 KB or more.*

```
CAUTION !
Can't Back Up
```

4 If you wish to verify the amount of remaining card memory...
 “Checking the Remaining Amount of Memory (Memory Information)” (p. 144)

.....
 If from the beginning you wish to reserve memory for creating a backup file, you can perform the User Backup operation to create a backup file immediately after formatting the card.

1. Make sure that a memory card is inserted into the memory card slot.
2. Hold down [SHIFT] and press keyboard pad [15].
You will enter the CARD section’s Format page.
3. Press PAGE [>] to select the User Backup page.

```
CARD:User BackUp
Are You Sure ?
```

4. Press [ENTER].

The following display will appear, and the User Backup operation will be carried out.

```
Processing...
Keep Power ON !
```

5. When User Backup has been completed, the following display will appear.

```
CARD:User BackUp
Complete !
```

If you wish to exit the setting page, press [EXIT].

** If you perform a User Backup operation on a card that already contains a backup file, the contents of the previous backup file will be lost.*

Restoring the Saved Settings Back to Internal Memory (Backup Load)

This operation loads the contents of a backup file that was saved on a card back into internal memory.

1. Make sure that the memory card is inserted in the memory card slot.
2. Hold down [SHIFT] and press keyboard pad [15].
You will enter the CARD section’s Format page.
3. Press PAGE [>] twice to select the Backup Load page.

```
CARD:BackUp Load
Are You Sure ?
```

4. Press [ENTER].

The following display will appear, and the Backup Load operation will be carried out.

```
Processing...
Keep Power ON !
```

5. When Backup Load is completed, the following display will appear.

```
CARD: BackUp Load
Complete !
```

To exit the setting page, press [EXIT].

Deleting the Backup File from the Card (Backup Delete)

When you no longer need a backup file that you created, you can delete the backup file. By deleting the backup file, you can increase the capacity of the card by 120,000 notes.

1. Make sure that a memory card is inserted into the memory card slot.
2. Hold down [SHIFT] and press keyboard pad [15].

You will enter the CARD section's Format page.

3. Press PAGE [>] three times to select the Backup Delete page.

```
CARD: BackUp Del
Are You Sure ?
```

4. Press [ENTER].

The following display will appear, and the Backup Delete operation will be carried out.

```
Processing...
Keep Power ON !
```

5. When Backup Delete is completed, the following display will appear.

```
CARD: BackUp Del
Complete !
```

To exit the setting page, press [EXIT].

Duplicating a Card (Card Duplicate)

This operation copies all data from a memory card to another memory card, to create an exact duplicate of the first card. If a card contains important data, it is a good idea to create a duplicate as a safety measure.

* The Card Duplicate operation can be used only with cards that are the same capacity. For example, it is not possible to copy a 2 MB card to a 4 MB card, or vice versa.

1. Prepare a copy source memory card and an empty memory card of the same capacity.

The copy destination card must already be formatted.

2. While holding down the BANK section [CARD] button, press the [POWER] button to turn on the power.

The following display will appear.

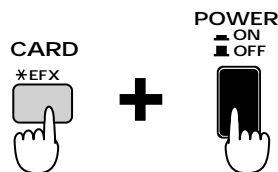

```
CARD DUPLICATE
Insert Src Card
```

3. Insert the copy source memory card into the memory card slot.

4. Press [ENTER].

The following display will appear.

```
Processing...
Keep Power ON !
```

5. After a time, the following display will appear, so remove the copy source card and insert the copy destination card.

```
CARD DUPLICATE
Insert Dest Card
```

* Even if the memory card was already formatted when you purchased it, it must be re-formatted on the MC-505.

6. Press [ENTER].

The following display will appear.

```
Processing...
Keep Power ON !
```

7. After a time, the following display will appear, so repeat steps 3D6.

```
CARD DUPLICATE
Insert Src Card
```

8. When the Card Duplicate operation has been completed, the following display will appear.

```
CARD DUPLICATE
Complete !
```

To exit the setting page, press [EXIT].

Installing the card protector

The MC-505 provides a card protector to prevent theft of the memory card. To install the card protector, use the following procedure.

- 1. Use a screwdriver to remove both screws that are at either side of the memory card slot.**
- 2. Insert the memory card into the memory card slot.**
- 3. Use the screws to fasten the card protector as shown below.**

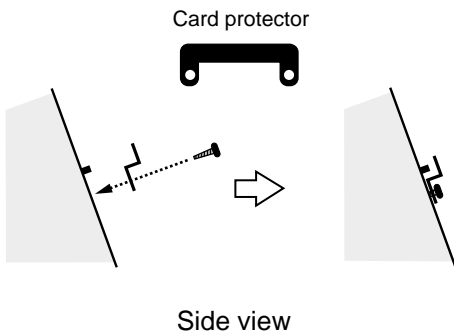

Chapter 15. Configuration (System)

Here you can make settings that affect the operation of the entire MC-505, such as tuning and the synchronization method. The settings of the various System parameters are remembered even while the power is turned off.

* It is not possible to access the various System setting pages while a pattern or song is playing back.

Tuning and Sound Generator Related Settings

1. Hold down [SHIFT] and press keyboard pad [9].

The display will show the setting page for the TUNE/SOUND section.

2. Use PAGE [<] [>] to select parameters within the section, and use [INC] [DEC] or the [VALUE] dial to set each parameter.

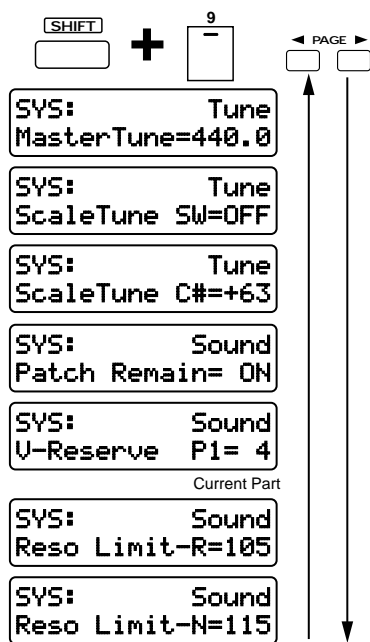

To exit the setting page, press [EXIT].

Adjusting the Overall Tuning (Master Tune)

This adjusts the tuning of the MC-505's sound generator. The display shows the frequency of the A4 note.

Range: 427.4–440.0–452.6 Hz

Tuning Each Note (Scale Tune)

By modifying the tuning of each of the 12 notes from C to B, you can play using a variety of temperaments.

Scale Tune SW (Scale Tune Switch)

Turn this on when you wish to use the Scale Tune function.

Range: OFF, ON

Tune (Scale Tune)

Adjusts the pitch of each note. The pitch is specified in 1-cent units relative to the equal tempered pitch.

Range: -64→+63

Press the appropriate keyboard pad to select the note that you wish to adjust.

.....
One cent is 1/100th of a semitone.
.....

About various temperaments

Equal temperament

This temperament divides the octave into 12 equal parts, and is the temperament that is most widely used today, particularly for Western music. When the Scale Tune Switch is OFF, the MC-505 will use equal temperament.

Just intonation (Tonic of C)

Compared to equal temperament, the principle triads will harmonize more perfectly. However this effect is obtained only in a single key, and if you modulate to a different key, the chords will be discordant.

Arabian-style temperament

This is an Arabian-style temperament. On the MC-505, you can enjoy Arabian-style temperament in the three keys of G, C and F.

Example

Note	Equal tempered	Just intonation (C is tonic)	Arabian-style temperament
C	0	0	-6
C#	0	-8	+45
D	0	+4	-2
D#	0	+16	-12
E	0	-14	-51
F	0	-2	-8
F#	0	-10	+43
G	0	+2	-4
G#	0	+14	+47
A	0	-16	0
A#	0	+14	-10
B	0	-12	-49

Specifying How Patches Will Be Switched (Patch Remain)

You can specify whether or not currently sounding notes will be turned off when another patch or rhythm set is selected.

Range: OFF, ON

If this is on, currently sounding notes will continue.

Specifying the Number of Notes for Each Part (Voice Reserve)

Specifies the number of notes that will be reserved for each part when the total number of requested notes exceeds 64.

Range: 0–64

Use [PART SELECT] and the PART buttons to select the part whose settings you wish to modify.

Voice Reserve settings can be made up to a total of 64 notes for all parts.

Specifying the Variable Range of Resonance (Resonance Limiter)

You can specify the range in which the [RESONANCE] knob can be adjusted.

You can make separate settings for the rhythm part [Reso Limit-R] and for the other parts [Reso Limit-N].

Range: 50–127

As this setting is increased, the variable range of the [RESONANCE] knob will increase.

Reso Limit-R = 100

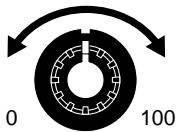

RESONANCE

Controller-Related Settings

1. Hold down [SHIFT] and press keyboard pad [10].

The display will show the CONTROLLER section setting page.

2. Use PAGE [<] [>] to select parameters within the section, and use [INC] [DEC] or the [VALUE] dial to set each parameter.

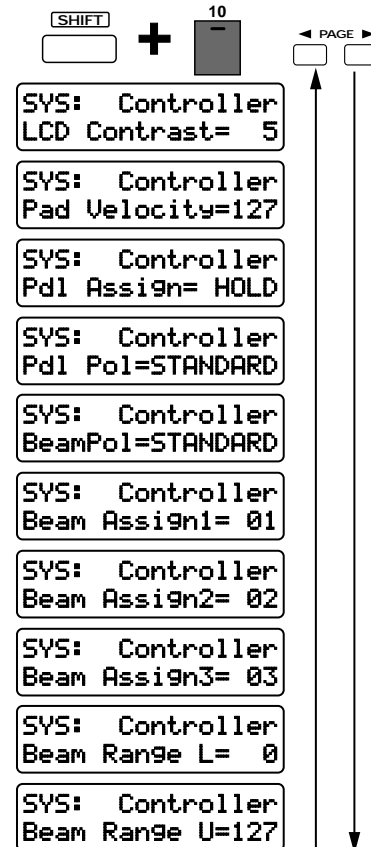

To exit the setting page, press [EXIT].

Adjusting the Display Contrast (LCD Contrast)

This adjusts the contrast (brightness) of the LCD display. Increasing this value will increase the contrast of the display.

Range: 1–16

Adjusting the Velocity Produced by Playing the Keyboard Pads (Pad Velocity)

When you use the keyboard pads to play, all notes will be sounded with the same velocity (strength). This setting specifies the velocity that will be used.

Range: 1–127

As this value is increased, notes played from the keyboard pad will be stronger.

Specifying How the Pedal Will Function

Pdl Assign (Pedal Assign)

This specifies the function of a pedal switch connected to the PEDAL jack.

Range:

HOLD: The pedal will act as a Hold Pedal.

SHIFT: The pedal will act like the SHIFT button.

FUNC: The pedal will act like the FUNC button.

PTN-I: (Pattern Increment) The patterns of the currently selected pattern set will be successively selected as the next pattern.

TAP: The pedal will act like the TAP button.

R-TPS: The pedal will act like the TRANSPOSE button.

PLAY: The pedal will act like the PLAY button / STOP button.

BEAM: The pedal will switch the DBeam controller on/off.

SOSTE: The pedal will act as a Sostenuato Pedal.

Pdl Pola (Pedal Polarity)

Select the polarity of the pedal.

Range: STANDARD, REVERSE

If you are using a pedal with inverted polarity (so the pedal functions in a way opposite from what you expect), select "REVERSE."

Specifying How the DBeam Controller Will Function

BeamPol (Beam Polarity)

Switch the polarity of the DBeam controller.

Range of settings: STANDARD, REVERSE

With a setting of "REVERSE," the direction of control for the DBeam controller will be inverted.

Beam Assign1 (Beam Assign 1)

Specify the style that will be selected when [TYPE SELECT] is used to make the top indicator light.

Range of settings: 01–28 (Type Number)

With the factory settings, "24" (24: Turntable) is selected.

Beam Assign2 (Beam Assign 2)

Specify the style that will be selected when [TYPE SELECT] is used to make the middle indicator light.

Range of settings: 01–28 (Type Number)

With the factory settings, "07" (07: Cut+Reso2-A) is selected.

Beam Assign3 (Beam Assign 3)

Specify the style that will be selected when [TYPE SELECT] is used to make the bottom indicator light.

Range of settings: 01–28 (Type Number)

With the factory settings, "27" (27: Adlib1) is selected.

Beam Range L (Beam Range Lower)

Specify the lower limit of the range of the DBeam controller.

Values below this setting will not be output.

Range of settings: 0–UPR

Beam Range U (Beam Range Upper)

Specify the upper limit of the range of the DBeam controller.

Values above this setting will not be output.

Range of settings: LWR–127

* It is not possible to set the Lower value above the Upper, nor the Upper value below the Lower. Also, the Beam Range Lower/Upper settings are valid only when the selected type is "05:Cut+Reso1-A"–"10:Cut+Reso3-S".

Sequencer-Related Settings

1. Hold down [SHIFT] and press keyboard pad [11].

The display will show the setting page of the SEQUENCER section.

2. Use PAGE [<] [>] to select parameters within the section, and use [INC] [DEC] or the [VALUE] dial to set each parameter.

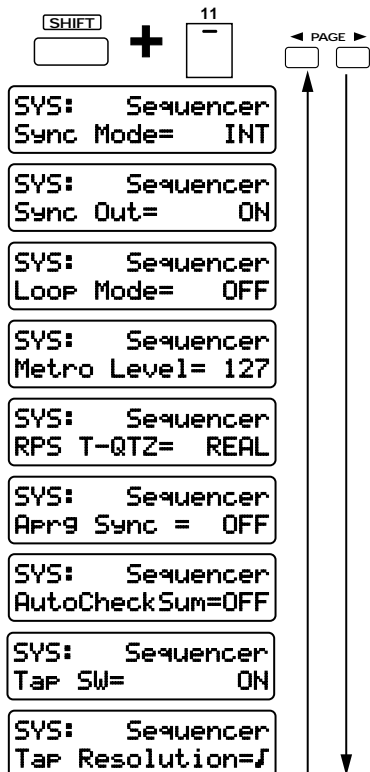

To exit the setting page, press [EXIT].

Synchronization Settings (Sync Mode)

This specifies how the internal sequencer will operate and how MIDI Clock messages will be transmitted and received.

Range:

INT: The internal sequencer will synchronize to the internal tempo clock, and will transmit MIDI Clock messages. Any MIDI Clock messages received from an external device will be ignored.

SLAVE: The internal sequencer will synchronize to MIDI Clock messages received from an external device. If no MIDI Clock messages are being received, pattern/song playback will not occur even if you press the [PLAY] button.

REMOTE: Operation will be essentially the same as "INT." However, Start/Stop messages from the external MIDI device will control playback/stop for the internal sequencer.

* When this is set to "SLAVE," the front panel SLAVE indicator will light.



Transmitting Synchronization Messages (Sync Out)

This specifies whether or not synchronization-related MIDI messages will be transmitted.

Range: OFF, ON

When this is on, the following messages will be transmitted from the MIDI OUT connector.

Timing Clock:	F8
Start:	FA
Continue:	FB
Stop:	FC
Song Position Pointer:	F2

Making Songs Play Continuously (Loop Mode)

This specifies how songs will play back.

You can make the same song play back continuously, or make all songs play back in succession.

Range:

OFF: This is the normal playback mode. The currently selected song will play back only once.

LOOP1: The currently selected song will play back repeatedly.

LOOP2: All songs will play back in succession.

* When using LOOP2 to playback a song, we recommend that a pattern which mutes all parts (i.e., a silent pattern) be inserted at the end of the song, so that songs are joined smoothly.

Adjusting the Metronome Volume (Metronome Level)

This sets the volume of the metronome.

Range: 0–127

Increasing this setting will raise the volume.

Specifying the Timing for RPS Playback (RPS Trigger Quantize)

When using RPS while a pattern is playing back, the playback of the pattern and the phrase may be skewed, depending on the timing at which you press the keyboard pad. On the MC-505 you can specify the playback timing of the phrase, so it will play back in precise synchronization with the pattern.

Range: REAL,   , MES

REAL: The phrase will play back immediately, at the timing at which you pressed keyboard pad.

16th: The pattern will be divided into 16th note units, and when you press the keyboard pad, the phrase will begin playing at the beginning of the next 16th note unit.

8th: The pattern will be divided into 8th note units, and when you press the keyboard pad, the phrase will begin playing at the beginning of the next 8th note unit.

4er: The pattern will be divided into quarter note units, and when you press the keyboard pad, the phrase will begin playing at the beginning of the next quarter note unit.

MES: The pattern will be divided into one-measure units, and when you press the keyboard pad, the phrase will begin playing at the beginning of the next measure. This lets you ensure that the phrase will begin playing at the beginning of the next measure.

* *Except when this parameter is set to "REAL," pressing the keyboard pad slightly before the actual desired timing will help you synchronize the phrase to the pattern.*

* *If the pattern is stopped, the phrase will play back immediately, regardless of this setting.*

Synchronizing Arpeggios to the Pattern (Arpeggio Sync)

You can specify whether or not arpeggios will be synchronized to the pattern playback.

Range: OFF, ON

With the factory settings, this will be "ON." If you do not want arpeggios to be synchronized to the pattern playback, turn Arpeggio Sync "OFF."

Calculating a Checksum Automatically (Auto Checksum)

This specifies whether or not the checksum will be calculated automatically when you use the Microscope page to input a system exclusive message.

Range: OFF, ON

With the factory settings this will be "ON." If you do not want the checksum to be calculated automatically, turn this "OFF."

Turning Off Tap Tempo (Tap Switch)

Specify whether or not [TAP] can be used to modify the tempo.

Range: OFF, ON

With a setting of "OFF," it will not be possible to use [TAP] to modify the tempo.

Specifying the Resolution of the Tap Tempo (Tap Resolution)

This specifies the basic note value that will be used when the TAP button is used to modify the tempo.

Range:  

When you press the TAP button, the tempo will be changed to intervals of the specified note value.

MIDI-Related Settings

1. Hold down [SHIFT] and press keyboard pad [12].

The MIDI section setting page will appear.

2. Use PAGE [<] [>] to select parameters within the section, and use [INC] [DEC] or the [VALUE] dial to set each parameter.

[SHIFT] + 12 PAGE
 SYS: MIDI Remote Kbd= ON
 SYS: MIDI Device ID= 17
 SYS: MIDI Thru= ON
 SYS: MIDI Rx SW +++++_+_ P1= ON
Part R 1 2 3 4 5 6 7 Current Part
 SYS: MIDI LocalTx IBIIIIII P1=BOTH
Part R 1 2 3 4 5 6 7 Current Part
 SYS: MIDI Arpeg Ctr1 Ch= 16
 SYS: MIDI RPS Ctr1 Ch= 15
 SYS: MIDI Edit TxRx= MODE1
 SYS: MIDI Rx.PG= ON
 SYS: MIDI Rx.Bank Sel= ON
 SYS: MIDI Rx.Sys-Ex= ON
 SYS: MIDI Tx.PG= ON
 SYS: MIDI Tx.Bank Sel= ON
 SYS: MIDI Tx.A-Sens= ON

To exit the setting page, press [EXIT].

Using an External MIDI Keyboard in Place of the Keyboard Pads (Remote Keyboard Switch)

An external MIDI keyboard can be used instead of the MC-505's keyboard pads.

Range: OFF, ON

The factory default settings call for this to be "ON," so regardless of the transmit channel setting of the external MIDI keyboard, it will play the patch of the current part.

If you wish to use the MC-505 as a 8-part multitimbral sound generator controlled by an external sequencer, turn this "OFF." This will allow MIDI messages transmitted from the external sequencer to play patches independently for each channel (part).

You should also turn this setting "OFF" if you want Note messages that are received on the specified Arpeggio Control Channel or the RPS Control Channel to control arpeggios or RPS from an external device.

- 📖 "Specifying the Channel That Will Control Arpeggios (Arpeggio Control Channel)" (p. 169)
- 📖 "Specifying the Channel That Will Control RPS (RPS Control Channel)" (p. 169)

Differentiating Between Units of the Identical Model (Device ID Number)

This parameter sets the Device ID Number.

MIDI devices have an identifying number called the Model ID, which is different for each model of device. When system exclusive messages are transmitted and received, this number is used to distinguish between different models. However, when two or more devices of the identical model need to receive and transmit system exclusive data independently, the Model ID by itself is not a sufficient distinction. For this reason, the Device ID Number is used to distinguish between two or more MC-505 units.

Range: 17–32

With the factory settings the Device ID Number is set at "17." If you are using only one MC-505, there is no need to change this setting.

Re-Transmitting Messages Received at MIDI IN from MIDI OUT (Thru Function)

When this function is "ON," MIDI messages received at the MIDI IN connector will be re-transmitted from MIDI OUT without change.

Range: OFF, ON

* When the arpeggiator is on, messages received at MIDI IN will not be re-transmitted from MIDI OUT even if this Thru setting is ON.

Specifying the Reception Status for Each Part (MIDI Rx Switch)

For each part [R]–[7], you can specify whether or not MIDI messages from MIDI IN will be received.

Use [PART SELECT] and the PART buttons to select the part whose setting you wish to change.

Range: OFF (-), ON (+)

If this is “OFF,” the corresponding part cannot be played from an external MIDI device.

Disconnecting the Keyboard Pads from the Internal Sound Generator (Local Tx Switch)

You can specify how MIDI messages from the controller section (the keyboard pad and knobs, sliders, DBeam Controller pedals etc.) will be sent to each part [R]–[7].

Use [PART SELECT] and the PART buttons to select the part whose setting you wish to modify.

Range:

INT (I): Messages from the controller section will be transmitted only to the internal sound generator.

EXT (E): Messages from the controller section will be transmitted only to MIDI OUT.

BOTH (B): Messages from the controller section will be transmitted both to the internal sound generator and to MIDI OUT.

Normally you will leave this set at “BOTH.”

If you do not want messages from the controller section to be transmitted from MIDI OUT, select “INT.”

If you want to use the controller section to control only the external sound generator, select “EXT.”

Specifying the Channel That Will Control Arpeggios (Arpeggio Control Channel)

This specifies the channel that note messages arriving from an external MIDI device need to be using in order to control the arpeggios when the Remote Keyboard Switch is “OFF.”

Range: OFF, 1–16

When note messages on the specified channel are received from an external device, an arpeggio will be

generated based on those notes, and played by the current part.

With the factory settings this is set at “16.”

 *“Using an External MIDI Keyboard to play RPS or Arpeggios” (p. 172)*

* If the Remote Keyboard Switch is “ON,” you can play arpeggios on the current part simply by turning the arpeggiator on.

Specifying the Channel That Will Control RPS (RPS Control Channel)

This specifies the channel that note messages arriving from an external MIDI device need to be using in order to control RPS when the Remote Keyboard Switch is “OFF.”

Range: OFF, 1–16

When note messages on the specified channel are received from an external device, RPS will play.

With the factory settings this is set at “15.”

 *“Using an External MIDI Keyboard to play RPS or Arpeggios” (p. 172)*

* If the Remote Keyboard Switch is “ON,” this setting is ignored.

Specifying How Knob Data Is Transmitted (Edit Transmit/Receive Mode)

This specifies the type of MIDI message that will be used to communicate with external devices when the front panel knobs/sliders are moved while the [TONE SELECT] indicator is dark.

* If a front panel knob/slider is moved while the [TONE SELECT] indicator is lit, the corresponding setting will be transmitted as a system exclusive message for each tone. In the same way, the data from the knobs of the REVERB section, DELAY section and EFX section will also be transmitted as system exclusive messages, regardless of the mode.

Range: MODE1, MODE2

MODE1: Knob/slider data will be transmitted and received as control changes and as system exclusive data.

MODE2: Knob/slider data will be transmitted and received as control changes.

With the factory settings this is set to “MODE1.”

* With MODE1, some control changes will be automatically converted to a system exclusive message for transmission. Also, when such a converted exclusive message is received, it will automatically be converted to a control change inside the MC-505.

* With MODE2, knobs and sliders will transmit and receive MIDI messages in a way that differs from the official MIDI specification. Be aware that MODE2 is a non-standard use of MIDI.



If you would like to know the control number assignments for each knob/slider in MODE1 and MODE2...

☞ “Transmit/Receive Setting List” (p. 233)

* If you want the MC-505 to receive MIDI messages that were transmitted from the knobs/sliders to an external device (and then re-transmitted back to the MC-505), you must select the same Edit Transmit/Receive Mode with which the data was originally transmitted. If this setting is different, MIDI messages will not be received correctly.

* [WAVE SELECT] data will not be transmitted, regardless of the mode.

Reception Settings for Each Type of Message

Rx.PG (Receive Program Change Switch)

Specifies whether or not each part will receive program changes.

Range: OFF, ON

When this is “OFF,” program changes will not be received.

Rx.Bank Sel (Receive Bank Select Switch)

Specifies whether or not each part will receive bank select messages.

Range: OFF, ON

When this is “OFF,” bank select messages will not be received.

Rx.Sys-Ex (Receive System Exclusive Switch)

Specifies whether or not each part will receive system exclusive messages.

Range: OFF, ON

When this setting is “OFF,” system exclusive messages will not be received.

Transmission Settings for Each Type of Message

Tx.PG (Transmit Program Change Switch)

Specifies whether or not program changes will be transmitted from MIDI OUT when the patch of each part is changed.

Range: OFF, ON

When this setting is “OFF,” program changes will not be transmitted.

Tx.Bank Sel (Transmit Bank Select Switch)

Specifies whether or not bank select messages will be transmitted from MIDI OUT when the patch of each part is changed.

Range: OFF, ON

When this setting is “OFF,” bank select messages will not be transmitted.

Tx.A-Sens (Transmit Active Sensing Switch)

Specifies whether or not Active Sensing messages will be transmitted from MIDI OUT.

Range: OFF, ON

When this setting is “OFF,” these messages will not be transmitted.

Chapter 16. Advanced Applications

Taking Advantage of MIDI

Switch)" (p. 168)

What Is MIDI?

The MC-505 records and plays back MIDI musical data, and when MIDI musical data is received its sound generator will produce sound.

What is MIDI?

MIDI (Musical Instrument Digital Interface) is a standard specification that allows musical data to be exchanged between electronic musical instruments and computers. Devices that have a MIDI connector can be connected using a MIDI cable, allowing them to transmit and receive data. Today, MIDI is found on virtually all electronic musical instruments. Without MIDI, it would not be possible to use an external keyboard to play the MC-505, or to use the MC-505 to record and play back a performance played on an external keyboard. Although you can use the MC-505 without knowing much at all about MIDI, you might also want to take full advantage of the possibilities offered by electronic musical instruments. This chapter will provide a simple explanation of the MC-505's MIDI-related functionality.

MIDI connectors

The MC-505 has two MIDI connectors, which function as follows.

MIDI OUT connector

This connector transmits MIDI messages to external MIDI devices.

MIDI IN connector

This connector receives MIDI messages that are transmitted from external MIDI devices. The MC-505 can receive these messages to play notes or select sounds, etc.

MIDI channels

MIDI is able to transmit large amounts of independent musical data over a single MIDI cable. This is made possible by the concept of "MIDI channels." MIDI channels allow messages intended for a given instrument to be distinguished from messages intended for another instrument. There are sixteen MIDI channels (1–16), and normally the transmitting device must be set to the same MIDI channel as the receiving device in order for messages to be received.

With the factory settings, the MC-505's Remote Keyboard setting is ON. In this condition, an external MIDI keyboard will be able to play the patch of the current part, regardless of its transmit channel setting.



☞ "Using an External MIDI Keyboard in Place of the Keyboard Pads (Remote Keyboard

* The transmit/receive channel settings of each part are as follows. It is not possible to change the channel settings of each part.

- Rhythm part: ch. 10
- Part 1: ch. 1
- Part 2: ch. 2
- Part 3: ch. 3
- Part 4: ch. 4
- Part 5: ch. 5
- Part 6: ch. 6
- Part 7: ch. 7

The flow of MIDI signals inside the MC-505 is as follows.

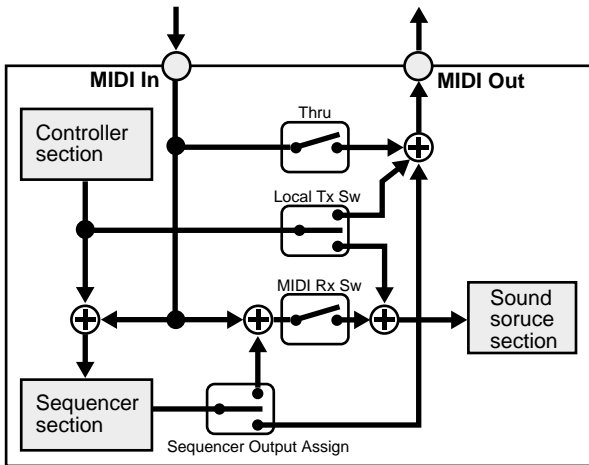

If you would like to know more about each parameter...

- ☞ "Re-Transmitting Messages Received at MIDI IN from MIDI OUT (Thru Function)" (p. 168)
- ☞ "Specifying the Reception Status for Each Part (MIDI Rx Switch)" (p. 169)
- ☞ "Disconnecting the Keyboard Pads from the Internal Sound Generator (Local Tx Switch)" (p. 169)
- ☞ "Specifying the Output Destination for Musical Data (Sequeencer Output Assign)" (p. 25)

When MIDI messages are being received from the MIDI IN connector, the MIDI indicator will light.

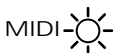

SLAVE ●

Playing the MC-505 from an External MIDI Keyboard

When the Remote Keyboard Switch is ON

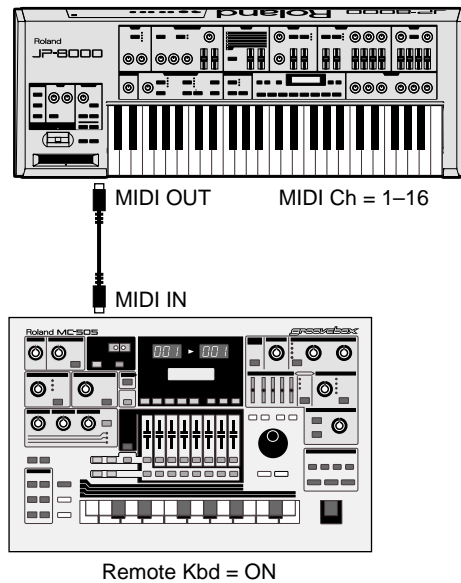

By changing the current part on the MC-505, you can change the part that will sound. The transmit channel of the external MIDI keyboard does not matter.

When the Remote Keyboard Switch is OFF

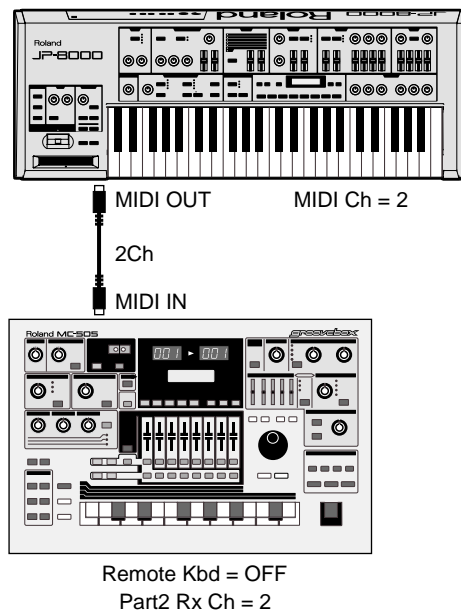

Set the transmit channel of the external MIDI keyboard to match the receive channel of the MC-505 that you wish to play. For example, if you wish to play part 2, set the transmit channel of the external MIDI key-

board to “2” since the receive channel of part 2 is “2.”

 “Using the an External MIDI Keyboard in Place of the Keyboard Pads (Remote Keyboard Switch)” (p. 168)

Selecting patches from an external MIDI device

By transmitting control change Bank Select messages (CC#0, CC#32) and Program Change messages (PC) from an external MIDI device to the MC-505, you can change the patch (rhythm set) of each part. At this time, the Receive Program Change Switch and the Receive Bank Select Switch must be turned ON (p. 170). For details on how bank select and program change messages are transmitted from your external MIDI device, refer to the owner’s manual for your device.

 If you would like to know how the incoming bank select and program change messages correspond to each patch (rhythm set), refer to:

- ☞ “Preset Patch List” (p. 192)
- ☞ “Preset Rhythm Set List” (p. 196)
- ☞ “MIDI Implementation” (p. 234)

Using an External MIDI Keyboard to Play RPS or Arpeggios

Playing RPS

1. Set the MC-505’s Remote Keyboard Switch to OFF (p. 168).
 2. Set the MC-505’s RPS Control Channel to match the transmit channel of the external MIDI keyboard (p. 169).
- It is a good idea to set the RPS Control Channel to a channel that will not conflict with the transmit/receive channels of each of the MC-505’s part.
3. Press [RPS] to make the indicator light.
 4. Press a note on the external MIDI keyboard, and an RPS will play.

The notes B1–D3 will play the RPS for keyboard pads [1]–[16] respectively.

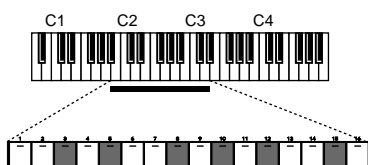

Playing arpeggios

If the Remote Keyboard Switch is “ON,” you can simply turn the arpeggiator on and play the external MIDI keyboard to produce arpeggios.

If the MC-505’s Remote Keyboard Switch is set “OFF,”

1. Set the MC-505’s Arpeggio Control Channel to match the transmit channel of the external MIDI keyboard (p. 169).

It is a good idea to set the Arpeggio Control Channel so it does not conflict with the transmit/receive channels of each of the MC-505’s parts.

2. Press ARPEGGIO [ON] to turn the arpeggiator on.
3. When you play the external MIDI keyboard, arpeggios will sound on the current part.

If the external MIDI keyboard that you are using has a “split” function (so separate sounds can be played in the left and right zones of the keyboard), you can play both arpeggios and RPS from your external MIDI keyboard. The following example shows how you can play arpeggios from the upper zone of the external MIDI keyboard and play RPS from the lower zone. Set the split point of the external MIDI keyboard to “D#3.”

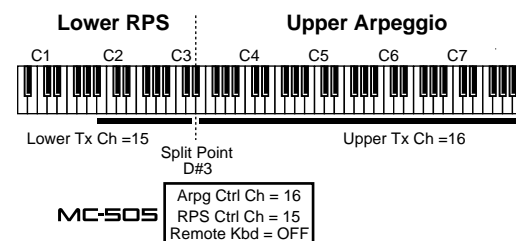

Playing the MC-505 from a Workstation (or Personal Computer)

If you wish to use a workstation or an external MIDI sequencer to play the MC-505 (instead of using the MC-505’s internal sequencer), or to connect the MC-505 to a personal computer that is running sequencer software, make connections as follows.

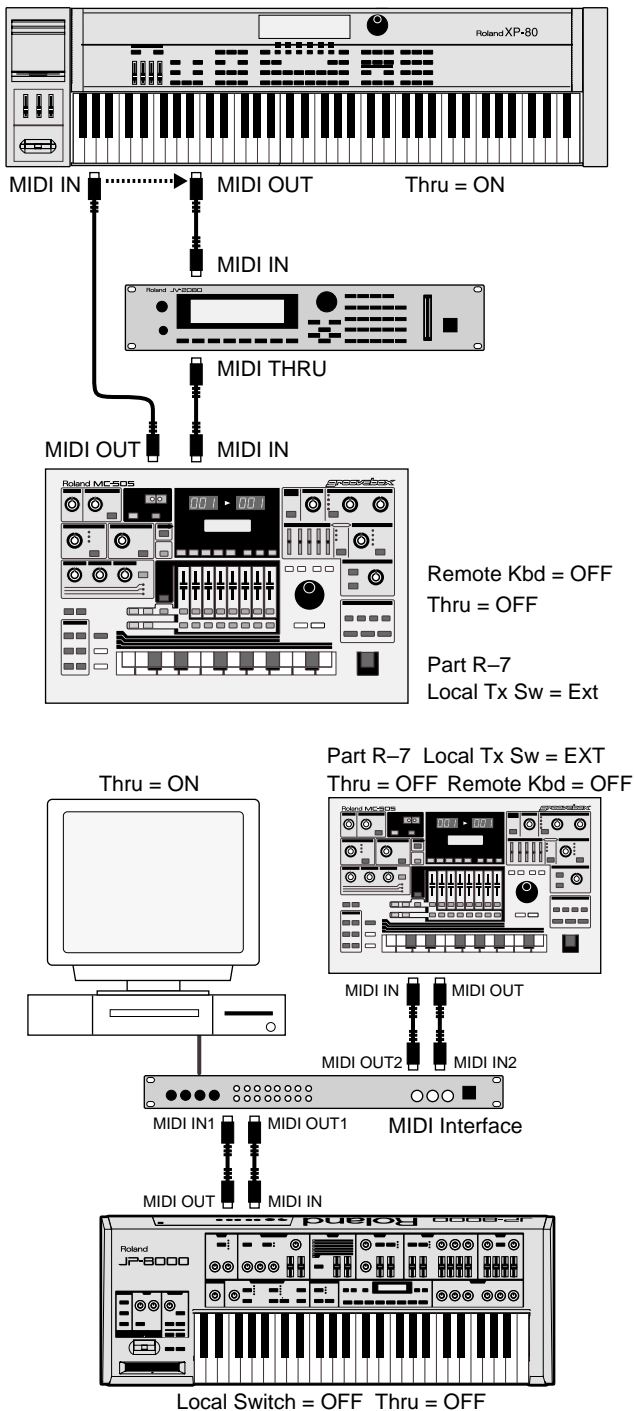

* If you wish to connect a computer and play the MC-505 from a MIDI sequencer program etc., you will need to use a MIDI interface appropriate for your computer.

1. Turn on the Thru function of your workstation (or MIDI sequencer software).

2. Make the following settings on the MC-505.

- Local Tx Switch for all parts: EXT (p. 169)
- Remote Keyboard Switch: OFF (p. 168)
- Thru function: OFF (p. 168)

3. Set the transmit channel (s) of your workstation (or MIDI sequencer software) to match the receive channel of the part (s) you wish to play.

If you have connected a workstation, you can play the keyboard of the workstation to sound the MC-505 while you record your playing on the workstation, or operate the knobs or arpeggiator etc. of the MC-505 and record this data on the workstation.

If the MC-505's MIDI OUT is connected to the MIDI IN of the MIDI interface or the external MIDI sequencer, you can operate the knobs/sliders and arpeggiator of the MC-505 and record this data.

* If you are also using an external MIDI sound module, you can avoid problems by turning off the receive channel and receive switch for parts that you will not be using.

Tempo synchronization when using the MC-505 as a sound module

By setting Sync Mode to "SLAVE" and then setting parameters such as LFO Rate, Delay Time and EFX Rate to be synchronized to the tempo, you can synchronize these parameters to the tempo of an external sequencer. However in this case, the MC-505 will respond to synchronization messages from the external sequencer and play back patterns. If you simply want to synchronize the sounds to the tempo, you should select an empty pattern that contains no musical data.

- ☞ "Adjusting the Speed of Modulation (LFO1 Rate)" (p. 51)
- ☞ "Adjusting the Delay Interval (Delay Time)" (p. 83)
- ☞ "Applying Various Effects to the Sound (EFX)" (p. 86)
- ☞ "Synchronization Settings (Sync Mode)" (p. 166)

Playing an External MIDI Device from the MC-505

Although it is fully enjoyable to play the MC-505 by itself, even more interesting uses become possible when it is used to control other MIDI devices as well.

Playing a sampler from the MC-505

By using the MC-505 in conjunction with a digital sampler such as the SP-202 or MS-1 (both sold separately), samples such as human voice or sound effects that were recorded on the sampler can be played from the keyboard pads of the MC-505. Or, you can create patterns that use both MC-505 sounds and sampled sounds, for more variation. Here we will give an

example showing how part 1 of the MC-505 can control the SP-202.

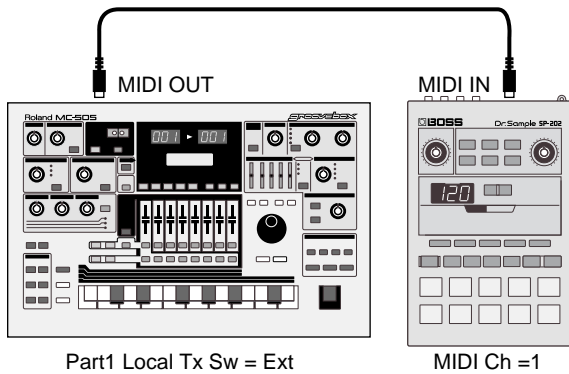

1. Set the MIDI channel of the SP-202 to 01.
2. Set the Local Tx Switch of the MC-505's part 1 to EXT (p. 169).
3. Select part 1 as the current part, and play the keyboard pads.

The sampled sounds of each pad of the SP-202 will sound.

Set the Octave Shift settings to "-2"-"0."

While you play back a pattern, try playing samples as well. Even after switching patterns, you can still control the SP-202 from part 1.

If you are using an MS-1

For the correspondence between the MC-505's keyboard pads and sampled sounds for each pad of the MS-1, refer to "Assigning keyboard notes to MS-1 pads" in the MS-1 owner's manual (p. 21).

With the factory settings of the MS-1, no sampled sounds are assigned to any black key other than the A# key. This means that even if you press the MC-505 keyboard pads "3," "5," "8," "10" or "15," no sample will sound. If you wish to play MS-1 samples from these keyboard pads, refer to the procedure "Changing key/pad assignments" (p. 21) in the MS-1 owner's manual, and set the appropriate note for each keyboard pad.

Next, let's record musical data on the MC-505 that will play the SP-202, and create a pattern that will add SP-202 sampled sounds to the performance of the MC-505.

1. Select the pattern to which you want to add SP-202 sampled sounds.

For this example as well, we will record the musical data for the SP-202 on part 1. If musical data has already been recorded on part 1, erase that data before you begin.

"Erasing Unwanted Data (Erase)" (p. 147)

2. Set the Sequencer Output Assign setting of the MC-505's part 1 to EXT (p. 25).
 3. Record the musical data for the SP-202 onto part 1.
- It is probably best to use real-time recording to record by pressing the keyboard pads.
4. When you are finished recording, press [PLAY] to play back the pattern.
- The SP-202 sampled sounds will play in addition to the sounds of the MC-505.
5. Use the Pattern Write operation to save the pattern (p. 26).

Playing an External MIDI Sound Generator from the MC-505

The same procedure can be used to control an external MIDI sound generator or a digital sampler other than the SP-202 or MS-1.

Example 1

In the following example, messages from an external MIDI keyboard are sent through the MC-505 to play an external MIDI sound generator, and recorded on the MC-505.

* Since the MIDI Rx switch of the MC-505 part 1 is turned OFF, part 1 will not be sounded by MIDI messages received from an external device.

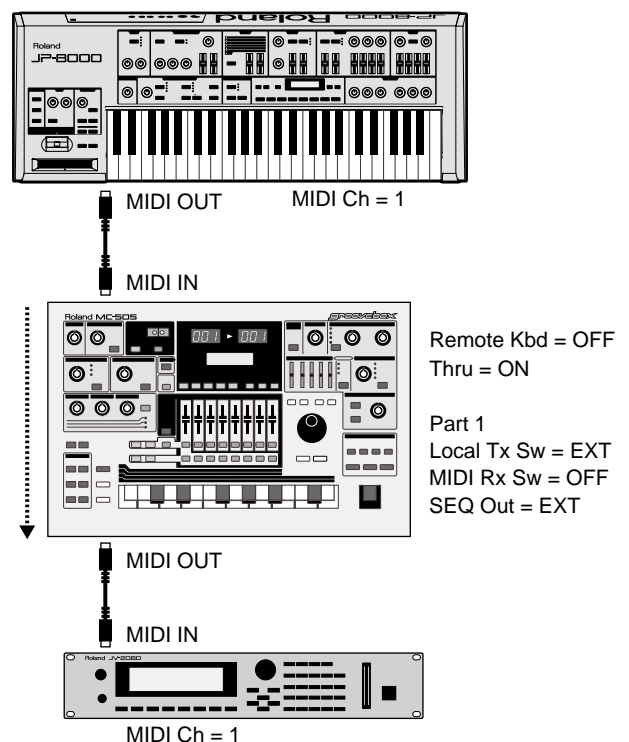

Example 2

In the following example, part 1 controls the external MIDI keyboard, and part 7 controls the SP-202.

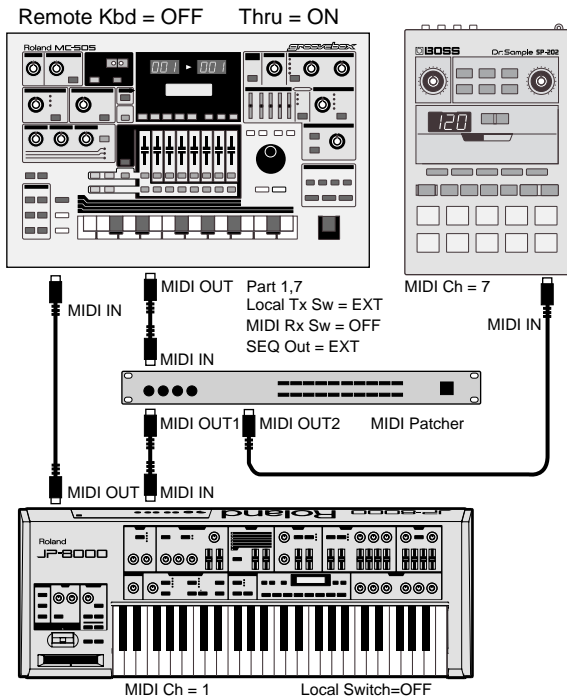

Set the transmit channel of the external MIDI keyboard to 7, and you can use the external MIDI keyboard to play the SP-202. When the MC-505's current part is part 1 or part 7, you will be able to play the external MIDI keyboard or the SP-202 from the keyboard pads.

When you record, the external MIDI keyboard will be recorded on part 1, and the SP-202 on part 7.

About MIDI patchers

When multiple external MIDI devices are connected in a "daisy-chain," there is a tendency for the signal to become corrupted and for transmission errors to occur as the signal is made to travel a greater distance. If you need to connect three or more devices, we recommend that you use a MIDI patcher (A-880: optional).

Synchronizing an External Sequencer

By synchronizing an external MIDI sequencer to the MIDI Clock messages that are transmitted from the MC-505, you can synchronize the external sequencer to the MC-505.

The following example shows how an external MIDI sequencer can be synchronized with the MC-505's pattern playback. (The external MIDI sound generator will be played by MIDI messages from the external MIDI sequencer.)

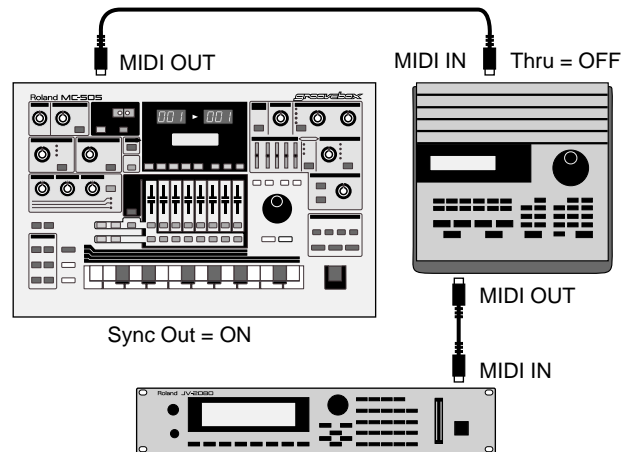

1. Press [MODE] to select Pattern mode.
2. Turn the Sync Out setting ON (p. 166).
3. Set the external MIDI sequencer so it will synchronize to the MIDI Clock messages that it receives. For details, refer to the owner's manual for your MIDI sequencer.
4. When you press [PLAY] on the MC-505, the MC-505's sequencer and the external MIDI sequencer will begin playback simultaneously.
5. To stop playback, press the MC-505's [STOP].

If you are using the MC-505 in conjunction with a JP-8000 synthesizer (optional), you can synchronize the JP-8000's arpeggios, patterns and motions to the MC-505. For details refer to the JP-8000 owner's manual section entitled "Synchronizing to External MIDI Devices" (p.95).

Synchronizing to an External Sequencer

The playback of the MC-505's sequencer can be synchronized to the MIDI Clock messages transmitted from an external MIDI sequencer or from a VS-880 hard disk recorder (optional).

In the following example, we will synchronize the MC-505 pattern playback to an external source of timing.

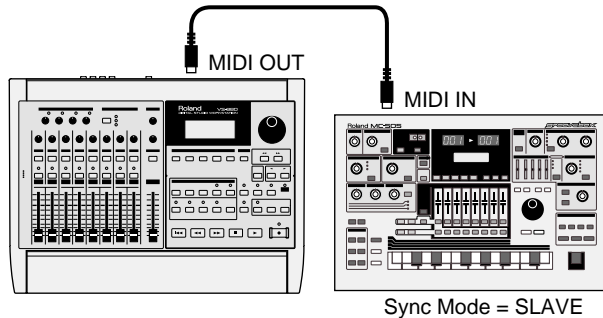

1. Press [MODE] to enter Pattern mode.
2. Set the Sync Mode setting to ÒSLAVEÓ (p. 166).
3. Make settings on your external MIDI sequencer so it will transmit MIDI Clock messages. For details on the setting, refer to the owner's manual for your external MIDI sequencer.
4. Return the MC-505 pattern to the beginning of measure 1.
5. Play back the external MIDI sequencer, and the MC-505's sequencer will begin playback simultaneously.
6. To stop playback, stop the external MIDI sequencer.

.....
 If you want only to control the pattern start/stop operations from the external MIDI sequencer without synchronizing to MIDI Clock messages from the external MIDI sequencer (so the tempo will be controlled by the MC-505 itself), set the Sync Mode to "REMOTE."

Synchronizing Two MC-505 to Each Other

Two MC-505 units can be connected to each other, and used to play different patterns in synchronization.

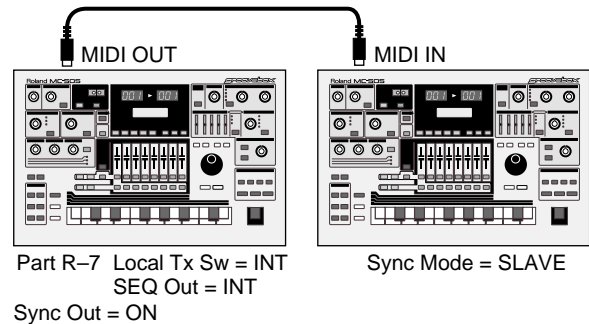

1. On the master unit (the MC-505 that will control the timing), set the Local Tx Switch of all parts to ÒINT,Ó and turn Sync Out ÒONÓ (p. 169, 166).
2. For all parts (including MUTE CTRL) of the pattern used by the master device, set the Sequencer Output Assign setting to ÒINTÓ (p. 25).

With these settings, the only messages transmitted from MIDI OUT will be synchronization signals.

3. On the slave unit (the MC-505 whose timing will be controlled), set the Sync Mode to ÒSLAVEÓ (p. 166).
4. Press [PLAY] on the master unit, and the two MC-505s will begin playback together. During synchronized playback, operating the knobs, arpeggio or RPS on the master unit will not affect the slave unit.
5. To stop synchronized playback, press [STOP] on the master unit.

You can use the same procedure to synchronize an MC-505 and an MC-303. In this case, use the MC-303 as the slave device, and set its Sync Mode setting to "SLAVE."

.....
 If the two patterns being synchronized have a different time signature or a different number of measures, the performance will move apart even if synchronization is maintained. When synchronizing in this way, it is recommended that you use patterns that have the same time signature and number of measures.

Saving Pattern and Patch Data on an External Sequencer (Bulk Dump)

The MC-505 is able to transmit or receive data for the currently selected pattern or patch. This is referred to as "Bulk Dump." By using this function, you can save MC-505 data on an external MIDI sequencer that has a floppy disk, or exchange data between two MC-505 units.

Recording MC-505 Data on an External Sequencer

Use a MIDI cable to connect the MC-505's MIDI OUT to the external sequencer's MIDI IN.

1. Select the pattern that you wish to save.
2. With the pattern stopped, hold down [SHIFT] and press keyboard pad [16].
The Bulk Dump page will appear in the display.

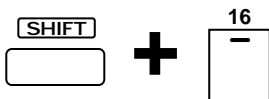

3. Press the PAGE [<] [>] several times to select the type of parameters that you wish to transmit.

Range:

SETUP: Setup parameters for all parts of the currently selected pattern will be transmitted.

SETUP&PATCH: In addition to the contents transmitted by SETUP, data for the patches (rhythm set) of all parts of the currently selected pattern will be transmitted.

ALL: In addition to the contents transmitted by SETUP&PATCH, the musical data of the currently selected pattern will be transmitted.

4. Start real-time recording on the external MIDI sequencer.
5. Press [ENTER] on the MC-505.
The following display will appear, and the bulk data will be transmitted from MIDI OUT.



When data transmission has been completed, the following display will appear, and then the normal display will reappear automatically.



6. Stop recording on the external MIDI sequencer, assign a name to the data that was recorded, and save it to floppy disk etc.

Restoring Data from a MIDI Sequencer to the MC-505

When you wish to restore the bulk dump that was saved back to the MC-505, use the following procedure to send the bulk dump into the temporary pattern.

Use a MIDI cable to connect the MC-505's MIDI IN to the MIDI OUT of the external sequencer.

1. Select the temporary pattern (U:TMP).
2. With the pattern stopped, hold down [SHIFT] and press keyboard pad [16].
The Bulk Dump page will appear in the display.
3. Press the PAGE [<] [>] several times to select the type of parameters that you wish to transmit.



4. Operate the external MIDI sequencer to load and play back the bulk dump that you wish to restore.

While the bulk dump is being loaded to the MC-505, the following display will appear.

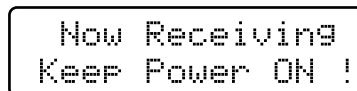

When loading has been completed, the Receive page will reappear.

5. Press [EXIT] to return to the normal display.
The temporary pattern will contain the setup, patch and pattern data that was loaded.
6. After verifying that the data was loaded correctly, save the patch and pattern data on the MC-505.

.....

After SETUP data has been received, use the Pattern Write operation to save the setup to user pattern memory. After SETUP&PATCH or ALL data has been received, first use the Patch Write operation to save the patches of all parts to vacant user patches. Then use the Pattern Write operation to save the setup and musical data as a user pattern.

.....

Tips for Creating Sounds

This section explains various tips that will be useful when you edit patches to create different types of sound. Refer to these hints and charts while you actually edit the sounds.

- * *Parameters that are not mentioned in the explanation will use the settings of the initial patch, and do not need to be set.*
- * *[RESONANCE] settings in the chart indicate the knob position when the Resonance Limiter (p. 164) is at the factory setting.*
- * *If you experience difficulty in using the knobs to make detailed adjustments, you can use [INC] [DEC] to adjust the value.*

Synth Lead

Let's make a conventional synth lead sound using a sawtooth waveform.

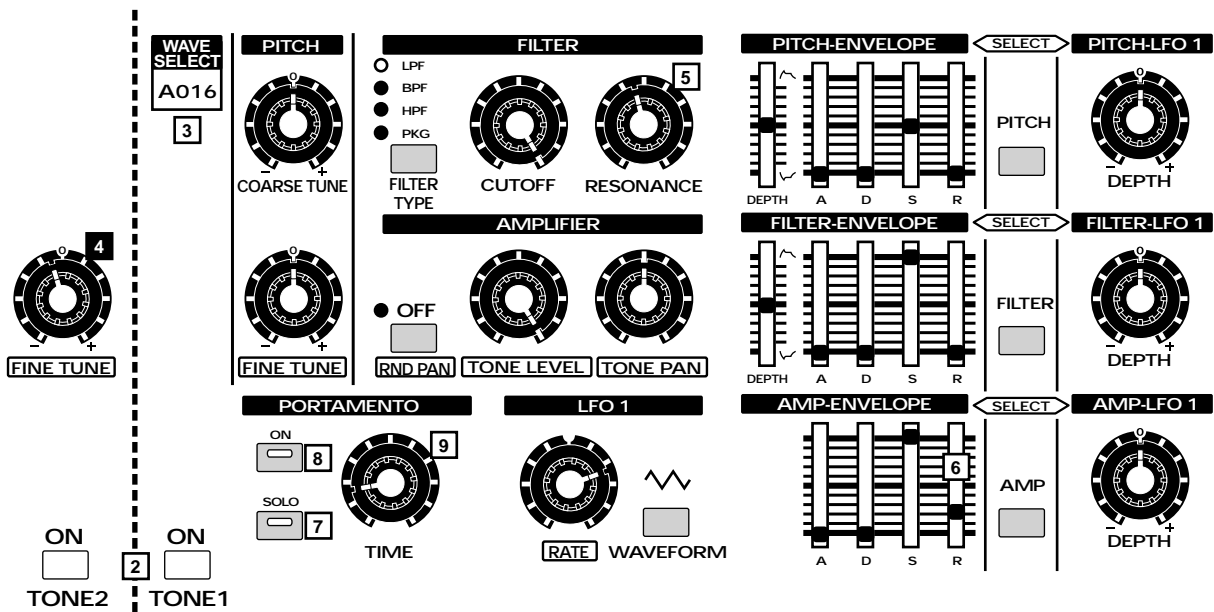

If you are playing the keyboard pads to hear the sound as you edit it, it is best to leave the Octave Shift setting at "0."

1. Execute the Patch Initialize operation to set the patch to the standard settings (the Initial Patch) (p. 62).
2. Turn on TONE1 and TONE2. (Hereafter, set TONE1 and TONE2 to the same settings unless otherwise specified.)
3. Use [WAVE SELECT] to select the A016 waveform.
4. Rotate the TONE2 [FINE TUNE] knob to the position (-2) shown in the diagram.
The pitch of the two tones will be skewed slightly, creating a rich sound.
5. As desired, you can rotate the [RESONANCE] knob to add character to the sound (50).
6. Move the A-ENV section [R] slider to the position (10) shown in the diagram.
A decay will remain after you release the key.
7. Press [SOLO] to turn on the Solo switch.
Now you will be able to play single notes.
8. Press PORTAMENTO [ON] to turn on Portamento.
9. Rotate the [TIME] knob to the position (10) shown in the diagram to adjust the amount of portamento.
As an effect, you may wish to apply a light delay. It will also be interesting to use EFX to apply some light flanging.

Synth Bass

Let's create a synth bass sound using a distorted square waveform.

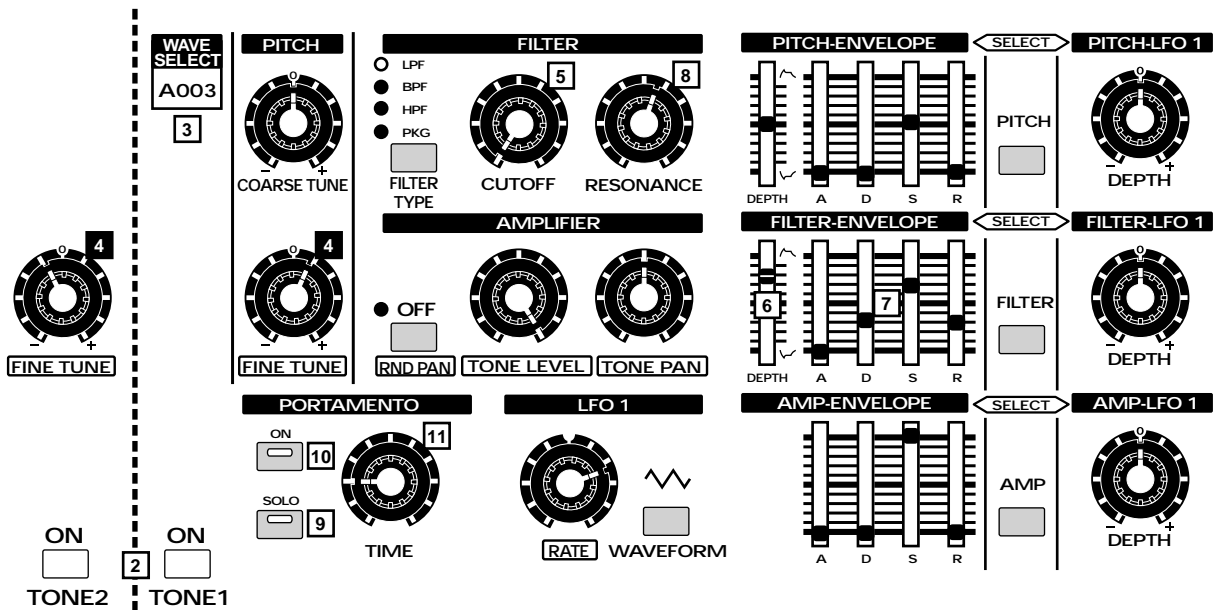

If you will be playing the keyboard pads to hear the sound as you edit, set Octave Shift to "-2."

1. Execute the Patch Initialize operation to set the patch to the standard settings (the Initial Patch) (p. 62).
2. Turn on TONE1 and TONE2. (Hereafter, set TONE1 and TONE2 to the same settings unless otherwise specified.)
3. Use [WAVE SELECT] to select the A003 waveform.
4. Rotate the TONE1 and TONE2 [FINE TUNE] knobs to the positions shown in the diagram (T1=+3, T2=-3).

This will give the bass sound greater thickness.

5. Rotate the [CUTOFF] knob to the position (0) shown in the diagram.

There will be no sound.

6. Move the F-ENV section [DEPTH] slider to the position (+43) shown in the diagram to determine the overall tonal character.
7. Move the F-ENV section [A][D][R] sliders to the positions shown in the diagram to specify how the tonal character will change over time (A=0/D=24/S=90/R=18).

8. Rotate the [RESONANCE] knob to the position (68) shown in the diagram to create the tonal character that is typical of synth bass sounds.

9. Press [SOLO] to turn on the Solo switch. Now you will be able to play single notes.

10. Press PORTAMENTO [ON] to turn on Portamento.

11. Rotate the [TIME] knob to the position (11) shown in the diagram to adjust the amount of portamento.

As an effect, you may wish to apply a short delay.

Synth Strings

Let's create a Synth Strings sound of the type often used as backing. Rather than playing individual, let's play chords so that you can hear the sound as you make these settings.

Troubleshooting

If there is no sound, or if the instrument does not function as you expect, first check the following points. If this does not resolve the problem, contact your dealer or the nearest Roland Service Center.

** Roland shall bear no responsibility whatsoever with regard to any loss of memory contents, or any consequent damages, whether direct or indirect.*

Problem

• : Reason

☞ : Action

No Sound

• The power of the MC-505 or connected devices is not turned on.

☞ Turn on the power (Quick Start; p. 4).

• The volume of the MC-505 or connected device is turned down.

☞ Raise the volume (Quick Start; p. 5).

• MIDI cables and/or audio cables are not connected correctly.

☞ Make the correct connections (Quick Start; p. 3).

• The Part Level of the corresponding part is lowered.

☞ Use the part slider to raise the Part Level (p. 24).

• All tones of the patch are turned off.

☞ Make [TONE SELECT] light, and press [BD]–[CLP] to turn each tone on so the indicators light (p. 33).

• The patch parameter settings are not appropriate.

☞ Raise the Sustain Level of the A-ENV section (p. 48).

☞ Raise the Cutoff Frequency of the FILTER section (p. 40).

☞ Raise the Tone Level of the AMPLIFIER-LEVEL section (p. 45).

☞ Raise the Rate of the LFO1/2 section (p. 51).

• The pitch of the patch has exceeded the range in which it can be sounded normally.

☞ Use Octave Shift to lower (raise) the range being played (p. 23).

• The Local Tx Switch of the corresponding part is set to "EXT."

☞ Set it to "INT" or "BOTH" (p. 169).

• The MIDI Rx Switch of the corresponding part is set to "OFF."

☞ Turn it "ON" (p. 169).

• The receive channel setting of the corresponding part does not match the MIDI channel of the messages that are being transmitted from the external MIDI device.

☞ Set the MIDI channel of the messages being transmitted to match the receive channel of each part (p.171).

• The Sequencer Output Assign setting of the corresponding part is set to "EXT."

☞ Set it to "INT" or "BOTH" (p. 25).

• The Pad Velocity setting is too low.

☞ Raise the Pad Velocity setting (p. 165).

• The Bank Select and Program Change messages transmitted from an external device have the wrong values.

☞ Transmit the correct Bank Select and Program Change messages (p. 192, 195).

Notes Drop Out

• You are attempting to play more than 64 notes simultaneously (p. 15).

☞ Reduce the number of notes that are played simultaneously.

☞ Reduce the number of notes in the pattern being played.

☞ Increase the Voice Reserve setting for parts that must not drop out (p. 164).

When You Play the Keyboard Pads, Notes Do Not Stop

• The [HOLD] indicator is lit.

☞ Press [HOLD] to make the indicator go dark.

Notes Are "Stuck" During Pattern Playback

• A Hold Off message was deleted by pattern editing etc.

☞ Use the Microscope page to insert a Hold Off message (p. 143).

CC#64 (HOLD1) Value=0

Sequencer Does Not Function (Pattern Playback, RPS Playback, etc.)

- The Sync Mode is set to "SLAVE."
- ☞ Set the Sync Mode to "INT" (p. 166).
If nothing happens if you press [STOP] when the [PLAY] indicator is lit, turn the power off and on again, and set Sync Mode to "INT."

Reverb/Delay/EFX Do Not Apply

- Reverb/Delay/EFX are turned off.
- ☞ Hold down [EFFECT SELECT], and press [PRESET]/ [USER]/ [CARD] to turn them on (p. 80, 83, 87).
- The Reverb Level setting and the Part Reverb Level settings of each part are set to "0."
- ☞ Increase the settings (p. 80).
- The Delay Level setting and the Part Delay Level settings of each part are set to "0."
- ☞ Increase the settings (p. 84).
- The EFX Output Level is "0." The Part EFX/Output Assign settings of each part are not set to "EFX."
- ☞ Increase the EFX Output Level. Set the Part EFX / Output Assign settings to "EFX" (p. 104).
- The Rhythm Tone Reverb Level or Rhythm Tone Delay Level of each note of the rhythm set you are using is set to "0." The Rhythm Tone EFX/Output Assign setting for each note is not set to "EFX."
- ☞ Increase the Rhythm Tone Reverb Level and the Rhythm Tone Delay Level of each note. Set the Rhythm Tone EFX/Output Assign settings to "EFX" (p. 76).

Pitch Is Incorrect

- The tuning of the MC-505 or of the external MIDI sound generator is incorrect.
- ☞ Check the tuning setting (p. 163).

The Pitch Has Been Changed by a Pitch Bend Message That Was Transmitted from the Sequencer or from an External MIDI Device.

- ☞ Perform A MIDI Update (p. 30).

Play Quantize Does Not Apply

- Either the Strength setting is at 0%, or the Shuffle Rate setting is at 50%.
- ☞ Set an appropriate value for the Strength or Shuffle Rate (p. 114, 115, 117).
- [QUANTIZE SELECT] has not been used to specify the part(s) to which Play Quantize will be applied.
- ☞ Specify the parts to which Play Quantize will be applied (p. 113).

Notes Are Delayed or Unsteady During Playback

- If you create a pattern that contains an extremely large amount of data, or if you input an excessive amount of knob data, notes may be delayed or unsteady during playback. This problem can also occur if the tempo is speeded up excessively, or for some combinations of Megamix.
- ☞ Delete unneeded note data or knob data. Use Data Thin to thin out knob data (p. 152).
- ☞ Use Move Event to move notes that were input at the same location as chords, so that they are staggered by 1 clock (p. 143).
- ☞ Use Shift Clock to move data of parts other than the rhythm part backward by 1 clock (p. 151).

Error Message List

If an incorrect operation has been performed or if processing could not be carried out as specified, an error message will appear. Refer to this list and take the appropriate action.

CAUTION !
MIDI Off Line

- **There is a problem with the MIDI cable connections.**

☞ Make sure that MIDI cables have not been pulled out or broken (Quick Start; p. 3).

CAUTION !
MIDI Buffer Full

- **More MIDI messages were received at once than the MC-505 was able to process.**

☞ Reduce the amount of MIDI messages that are being transmitted to the MC-505.

CAUTION !
Rec Overflow

- **More recording data was received at once than the MC-505 was able to process.**

☞ Reduce the amount of recording data that is being transmitted to the MC-505.

CAUTION !
Checksum Error

- **The checksum value of the received system exclusive message is incorrect.**

☞ Correct the checksum value.

CAUTION !
PTN Rec Full

- **Since the maximum number of notes that can be recorded in a single pattern has been reached, further pattern recording is not possible.**

☞ Delete unneeded data from the pattern that you are recording (p. 147).

CAUTION !
Song Rec Full

- **Since the maximum number of patterns that can be registered in a single song has been reached, further song recording is not possible.**

☞ A maximum of 50 patterns can be registered in a single song. No further patterns can be registered.

CAUTION !
Cannot Recording

- **Recording is not possible because Megamix mode is selected.**

☞ Write the pattern, and then record.

CAUTION !
User Memory Full

- **Since there is insufficient user memory, the pattern cannot be saved.**

☞ Either initialize an unneeded pattern, or save the data to a memory card.

CAUTION !
Card Memory Full

- **Since there is insufficient card memory capacity, the pattern cannot be saved.**

☞ Either initialize an unneeded pattern, or save the data to internal memory.

CAUTION !
Beat Differs

- **Since a different time signature is set for the copy source and copy destination patterns, the pattern copy is not possible.**

☞ The pattern copy operation can only be used for patterns with the same time signature.

CAUTION !
Cannot Assign

- Since there are two or more un-muted parts, the phrase cannot be assigned to an RPS set.

☞ Decide on one part in the phrase that you wish to register, and mute all other parts (p. 110).

CAUTION !
No QTZ Selected

- Quantize is not selected.

☞ Press [QUANTIZE] to select the quantization that you wish to use (p. 113).

CAUTION !
Memory Protected

- Since a write protect sticker is affixed to the memory card, data cannot be saved to the card bank.

☞ Remove the write protect sticker from the memory card (p. 159).

CAUTION !
Empty Pattern

- Since the pattern contains no musical data, it cannot be played back.

CAUTION !
Cannot UNDO

- Cannot undo.

CAUTION !
Wrong Card

- The card manufacturer/model is not specified for use with the MC-505.

☞ Use a specified card (p. 159).

- The card has not been formatted for the MC-505.

☞ Format the card (p. 159).

- It is possible that the contents of the card have been damaged.

☞ Format the card (p. 159).

- The card does not contain MC-505 data.

☞ Use a card that contains MC-505 data.

CAUTION !
Card Not Ready

- No card is inserted.

☞ Turn off the power, and insert a card (p. 159).

CAUTION !
Card Damaged

- Since the copy destination card contains a defective block, the Card Duplicate operation cannot be carried out.

☞ The memory card has reached the end of its lifespan. Please purchase a new memory card.

CAUTION !
Memory Damaged!

- It is possible that the contents of internal memory have been damaged.

☞ Try executing the Factory Preset operation (Quick Start, p. 5). If this does not resolve the problem, contact a nearby Roland service center.

Waveform List

Group A

No	Name	No	Name	No	Name	No	Name	No	Name
001	TB Dst Saw	052	Ac Bass	103	Trumpet	154	Dist Hit	205	TR808 Tom
002	TB Dst Sqr 1	053	Voco Bass	104	Mute Trumpet	155	Thin Beef	206	TR606 Tom
003	TB Dst Sqr 2	054	Fingered Bs	105	Soprano Sax	156	Tekno Hit	207	TR606 CmpTom
004	TB Reso Sqr1	055	Pick Bass	106	Solo Sax	157	Back Hit	208	TR707 Tom
005	TB Reso Sqr2	056	Fretless Bs	107	Baritone Sax	158	TAO Hit	209	Syn Tom
006	TB Saw	057	Slap Bass	108	Brass Fall	159	Philly Hit	210	Deep Tom
007	TB SolidSaw1	058	Juno Rave	109	Flute	160	INDUST. MENU	211	Can Tom
008	TB SolidSaw2	059	Blaster	110	Pan Flute	161	Analog Bird	212	Kick Tom
009	TB Square 1	060	Fat JP-6	111	Shakuhachi	162	Retro UFO	213	Natural Tom
010	TB Square 2	061	OB Strings	112	Bagpipe	163	PC-2 Machine	214	PERCUS MENU1
011	TB Sqr Decay	062	Orch Strings	113	Breath	164	Hoo	215	PERCUS MENU2
012	TB Natural	063	Pizzy Techno	114	Feedbackwave	165	Metal Sweep	216	TR808 Conga
013	JP8000 Saw 1	064	Choir	115	Atmosphere	166	Afro Feet	217	HiBongo Open
014	JP8000 Saw 2	065	Syn Vox 1	116	Rezo Noise	167	Bomb	218	LoBongo Open
015	MG Saw	066	Syn Vox 2	117	MG White Nz	168	Bounce	219	HiConga Mute
016	Synth Saw 1	067	Syn Vox 3	118	P5 Noise	169	ElectricDunk	220	HiConga Open
017	JP-8 Saw	068	Ac Piano	119	MG Pink Nz	170	Iron Door	221	LoConga Open
018	P5 Saw	069	D-50 EP	120	Bomb Noise	171	Dist Swish	222	HiBongo LoFi
019	Synth Saw 2	070	E.Piano	121	Sea	172	Drill Hit	223	LoBongo LoFi
020	OB Saw	071	Clavi	122	Brush Noise	173	Thrill	224	HiCnga Mt LF
021	D-50 Saw	072	Full Stop	123	Space Noise	174	PCM Press	225	HiCnga Op LF
022	JP-6 Square	073	FM Club Org	124	Scream	175	Air Gun	226	LoConga LoFi
023	MG Square	074	E.Organ 1	125	Jet Plane	176	VOICE MENU	227	Timpani
024	P5 Square	075	E.Organ 2	126	Toy Gun 1	177	One!	228	Mute Surdo
025	JP-8 Pulse	076	Church Org	127	Crash	178	Two!	229	Open Surdo
026	JP-6 Pulse	077	Power B fst	128	Toy Gun 2	179	Three!	230	Hi Timbale
027	MG Pulse	078	Power B slw	129	Toy Gun 3	180	Kick it!	231	Lo Timbale
028	260 Pulse	079	Org Chord	130	Emergency	181	Come on!	232	HiTimbale LF
029	JU-2 Sub OSC	080	Tubular	131	Buzzer	182	Wao!	233	LoTimbale LF
030	Frog wave	081	Glockenspiel	132	Insect	183	Shout	234	Tabla
031	Digiwave	082	Vibraphone	133	Tonality	184	Ooh! 1	235	TablaBaya
032	FM Pulse	083	FantabellSub	134	Ring Osc	185	Ooh! 2	236	Udo
033	JP8000 PWM	084	DIGI Bell	135	Reso FX	186	Voice loop	237	AfroDrum Rat
034	JP8000 FBK	085	Steel Drum	136	SCRATCH MENU	187	Pa!	238	Chenchen
035	260 Sub OSC	086	Marimba	137	Vinyl Noise	188	Canvas	239	Op Pandeiro
036	Dist Synth	087	Balaphone	138	Scratch BD f	189	Punch	240	Mt Pandeiro
037	Dist Square	088	Kalimba	139	Scratch BD r	190	Chiki!	241	Tambourine 1
038	MG Triangle	089	Steel Gtr	140	Scratch SD f	191	Hey!	242	Tambourine 2
039	Jungle Bass	090	Clean TC	141	Scratch SD r	192	Laugh	243	Tambourine 3
040	260 Sine Bs	091	Dst Solo Gtr	142	Scratch ALT	193	Aah Formant	244	Tambourine 4
041	MC-202 Bass	092	Dist TekGtr	143	Tape Rewind	194	Eeh Formant	245	CR78 Tamb
042	SH-101 Bass	093	Gtr FX	144	Vinyl Stop	195	Iih Formant	246	COWBELL MENU
043	Octa Bass	094	Harmo Gtr	145	HIT MENU	196	Ooh Formant	247	TR808Cowbell
044	Funky Bass	095	Wah Gtr 1	146	MG Blip	197	Uuh Formant	248	TR707Cowbell
045	Poly Bass	096	Wah Gtr 2	147	Beam HiQ	198	Dist Ooh Vox	249	CR78 Cowbell
046	MG Bass	097	Wah Gtr 2a	148	MG Attack	199	Auh Voice	250	Cowbell
047	FM Super Bs	098	Wah Gtr 2b	149	Air Blip	200	Stream	251	TR727 Agogo
048	Solid Bass	099	Wah Gtr 2c	150	Org Click	201	Bird	252	CR78 Beat
049	Organ Bass	100	Wah Gtr 2d	151	Syn Hit	202	TOM MENU	253	Triangle 1
050	Dirty Bass	101	Sitar	152	Techno Scene	203	TR909 Tom	254	Triangle 2
051	Upright Bs	102	Brass	153	Techno Chord	204	TR909 DstTom		

Group B

No	Name	No	Name	No	Name	No	Name	No	Name
001	SHKR+ MENU	052	R8 Brush CHH	103	TR707 Clap	154	Rap Snare	205	ElectroSnr 2
002	808 Maracas	053	Jungle Hat	104	Cheap Clap	155	Jungle Snr 1	206	Synth Snare
003	Maracas	054	PHH MENU	105	Funk Clap	156	Antigua Snr	207	Roll Snare
004	Cabasa Up	055	TR909 PHH 1	106	Little Clap	157	Real Snare	208	KICK MENU 1
005	TechnoShaker	056	TR909 PHH 2	107	Real Clap 1	158	Tiny Snare 1	209	KICK MENU 2
006	TR626 Shaker	057	TR808 PHH 1	108	Real Clap 2	159	Tiny Snare 2	210	KICK MENU 3
007	Dance Shaker	058	TR808 PHH 2	109	Funky Clap	160	Break Snare1	211	TR909 Kick 1
008	CR78 Guiro	059	TR606 PHH 1	110	Comp Clap	161	Break Snare2	212	TR909 Kick 2
009	Long Guiro	060	TR606 PHH 2	111	Hip Clap	162	MC Snare	213	TR909 Kick 3
010	Short Guiro	061	TR707 PHH	112	Down Clap	163	East Snare	214	TR909 Kick 4
011	Mute Cuica	062	Hip PHH	113	Group Clap	164	Phat Snare	215	Plastic BD 1
012	Open Cuica	063	Tight PHH	114	Big Clap	165	Brush Slap 1	216	Plastic BD 2
013	Whistle	064	Pedal Hat 1	115	Claptail	166	Brush Slap 2	217	Plastic BD 3
014	TR727Quijada	065	Real PHH	116	Clap Snare 1	167	Deep Snare	218	Plastic BD 4
015	Jingle Bell	066	Pedal Hat 2	117	Fuzzy Clap	168	Fat Snare	219	TR909 Kick 5
016	Belltree	067	OHH MENU 1	118	Snap	169	Disco Snare	220	TR808 Kick 1
017	Wind Chime	068	OHH MENU 2	119	Finger Snap	170	DJ Snare	221	TR808 Kick 2
018	RIM MENU	069	TR909 OHH 1	120	SNR MENU 1	171	Macho Snare	222	TR808 Kick 3
019	TR909 Rim	070	TR909 OHH 2	121	SNR MENU 2	172	Hash Snare	223	TR808 Kick 4
020	TR808 Rim	071	TR909 OHH 3	122	SNR MENU 3	173	Lo-Hard Snr	224	TR808 Kick 5
021	TR808 RimLng	072	TR909 DstOHH	123	SNR MENU 4	174	Indus Snare	225	TR606 Kick
022	TR707 Rim	073	TR808 OHH 1	124	SNR MENU 5	175	Rage Snare	226	TR606 Dst BD
023	Analog Rim	074	TR808 OHH 2	125	SNR MENU 6	176	TekRok Snare	227	TR707 Kick 1
024	Natural Rim	075	TR606 OHH	126	TR909 Snr 1	177	Big Trash SD	228	TR707 Kick 2
025	Ragga Rim 1	076	TR606 DstOHH	127	TR909 Snr 2	178	Ragga Rim 2	229	Toy Kick
026	Lo-Fi Rim	077	TR707 OHH	128	TR909 Snr 3	179	Gate Rim	230	Analog Kick
027	Wood Block	078	CR78 OHH	129	TR909 Snr 4	180	SideStiker	231	Boost Kick
028	Jungle Snap	079	Hip OHH	130	TR909 Snr 5	181	HipJazz Snr	232	West Kick
029	TR808 Claves	080	Pop Hat Open	131	TR909 Snr 6	182	HH Soul Snr	233	JungleKick 1
030	Hyoshigi	081	Open Hat	132	TR909 Snr 7	183	Cross Snare	234	Optic Kick
031	CHH MENU 1	082	Cym OHH	133	TR909 DstSnr	184	Jungle Rim 1	235	Wet Kick
032	CHH MENU 2	083	DR550 OHH	134	TR808 Snr 1	185	Ragga Snr 2	236	Lo-Fi Kick 1
033	TR909 CHH 1	084	Funk OHH	135	TR808 Snr 2	186	Upper Snare	237	Hazy Kick
034	TR909 CHH 2	085	Real OHH	136	TR808 Snr 3	187	Lo-Fi Snare	238	Hip Kick
035	TR808 CHH 1	086	R8 OHH	137	TR808 Snr 4	188	RaggaTightSD	239	Video Kick
036	TR808 CHH 2	087	CYMBAL MENU	138	TR808 Snr 5	189	Flange Snr	240	Tight Kick
037	TR808 CHH 3	088	TR606 Cym 1	139	TR808 Snr 6	190	Machine Snr	241	Break Kick
038	TR606 CHH 1	089	TR606 Cym 2	140	TR808 Snr 7	191	Clap Snare 3	242	Turbo Kick
039	TR606 CHH 2	090	TR909 Ride	141	TR808 Snr 8	192	Solid Snare	243	Ele Kick
040	TR606 DstCHH	091	TR707 Ride	142	TR808 Snr 9	193	Funk Clap 2	244	Dance Kick 1
041	TR707 CHH	092	Natural Ride	143	TR606 Snr 1	194	Jungle Rim 2	245	Kick Ghost
042	CR78 CHH	093	Cup Cym	144	TR606 Snr 2	195	Jungle Rim 3	246	Lo-Fi Kick 2
043	DR55 CHH 1	094	TR909 Crash	145	TR606 Snr 3	196	Jungle Snr 2	247	JungleKick 2
044	Closed Hat	095	NaturalCrash	146	DanceHall SD	197	Urban Snare	248	TR909 Dst BD
045	Pop CHH	096	Jungle Crash	147	TR707 Snare	198	Urban RollSD	249	Amsterdam BD
046	Real CHH	097	Asian Gong	148	CR78 Snare	199	R&B Snare	250	Gabba Kick
047	Bristol CHH	098	CLAP MENU 1	149	Clap Snare 2	200	R8 Brush Tap	251	Roll Kick
048	DR550 CHH 2	099	CLAP MENU 2	150	Jngl Tiny SD	201	R8 BrshSwill		
049	Tight CHH	100	TR909 Clap 1	151	Jazz Snare	202	R8 BrushRoll		
050	Hip CHH	101	TR909 Clap 2	152	Headz Snare	203	Sim Snare		
051	Room CHH	102	TR808 Clap	153	Whack Snare	204	ElectroSnr 1		

Preset Patch List

Preset A (CC#0 = 81, CC#32 = 0)

No. Name	No. Name	No. Name
001: Lead TB 1	051: SinusoidRave	101: Gate Me Buzz
002: Dist TB 1	052: Sine Me Up	102: System Bass
003: Dist Sqr TB	053: Spooky Sine	103: Spike Bass
004: Dist TB 2	054: Sine Tone	104: Solid Goa
005: Dist TB 3	055: D50 Saw Lead	105: Rezo Bass
006: TB + Voco	056: Dst Syn Lead	106: Blip Bass
007: Dist TB 4	057: Big Up Massv	107: Pizz Bass
008: Lead TB 2	058: Warm SawLead	108: Voco Bass
009: Devil TB	059: Hartnoll Era	109: VoCoRoBo
010: Dual TB	060: Skegness 97	110: Dust Bass
011: HiLo303ModSw	061: Simply June	111: ArtCore Bass
012: Arpness TB	062: The Brothers	112: NU-NRG Bass
013: Acid Line	063: Dist Lead 2	113: TalkBox Bass
014: Dist TB 5	064: Dark SawLead	114: Incontinence
015: Lead TB 3	065: Dist Lead 3	115: Bari Voice
016: Lead TB 4	066: Mosquito	116: Ac.Bass
017: TB Tra Bass	067: Phazyn Vox	117: E.Ac.Bass
018: Acid TB	068: Voc Saw	118: Acid Jazz Bs
019: Psyche-TB	069: VT Vox	119: Soup's Bass
020: TB + Sine	070: Pure Voice	120: Fingered Bs
021: Hi-Pass TB	071: Robo Vox	121: FingBsVeloSw
022: Moog Saw	072: Hallucinate	122: PickedBass 1
023: OB Saw	073: Seq.Synth	123: PickedBass 2
024: MG Lead	074: Analog Seq	124: Fretless Bs
025: Poly Key	075: Ana Punch	125: Phot Bass
026: Synth Pulse	076: Atom Brain	126: Slap Bass
027: Dual Profs	077: Fooled MC	127: R&B B-Slides
028: Axe of 80	078: 101 Bass 1	128: Syn Stack 1
029: MG Square	079: House Bass	
030: Square Lead1	080: 101 Bass 2	
031: Square Lead2	081: 202 Bass	
032: Square Lead3	082: Psycho Funk	
033: Lucky	083: Talking Line	
034: Synth Lead 1	084: Inside Bass	
035: Moon Lead	085: Bubble Bass	
036: Rezo SynLead	086: Bass Bleep	
037: Wspy Synth	087: Wiggle Bass	
038: Enorjizor	088: Twist Bass	
039: JP8 Sprang	089: Octa Bass	
040: PortaSynLead	090: BT's Sticky	
041: Wah Lead	091: MG Bass	
042: Beep Mod	092: FM Super Bs	
043: Dist Lead 1	093: Solid Bass	
044: Freaky Fry	094: T Nite Bass	
045: JU2 SubOsc 1	095: Front 505	
046: JU2 SubOsc 2	096: Def Bass 1	
047: Froggy	097: Def Bass 2	
048: Synth Lead 2	098: Sine Bass 1	
049: Singin' MINI	099: Sine Bass 2	
050: Plastic Tone	100: RollModRezBs	

Preset B (CC#0 = 81, CC#32 = 1)

No. Name	No. Name	No. Name
001: Strong Brass	051: Floating Pad	101: Rev Cord
002: You Can Fly	052: Fancy Pad	102: Blue Random
003: Syn stack 2	053: Strings 1	103: Sync Tone
004: Dawn Of Man	054: Strings 2	104: Seq Up
005: Saw Stack 1	055: Old StringSW	105: SawLFOSaw
006: Saw Stack 2	056: Swim Strings	106: Calculating
007: DLM Stack	057: Eclip-Str	107: Touch EF
008: DOC Stack	058: Slow Strings	108: Welding
009: LN2 Stack	059: OB Slow Str	109: Press Machin
010: Bend Stack	060: Syn.Strings1	110: EF Tribe
011: Freedom	061: Syn.Strings2	111: Scratch Alt
012: Good Bean	062: OB Strings	112: Analog FX
013: JP8000 5th	063: Rhap Strings	113: Non TB
014: Mega 5th	064: Banded Jupe	114: Nasty Filt
015: 5th Saw	065: NU-NRG Str	115: Psy-Ence
016: 4th Saw	066: Violin	116: Music Hi
017: Soundtrack	067: Contrabass	117: Uber Zone
018: Rise Pad	068: Tremolo Str	118: Down Gown
019: Warm Pad	069: Pizzicato 1	119: For Giving
020: JP + OB Pad	070: Pizzicato 2	120: Sound Alarm
021: Planet	071: Pizz It	121: Acid Drone
022: Additive	072: Guardians	122: X-Mod
023: Noise Pad	073: Gat Passion	123: X-FM/Org
024: Sweep Pad 1	074: Syn Harp	124: X-FM Bass
025: Sweep Pad 2	075: Voice Oohs	125: Hard BD?
026: Alles Padde	076: Solo Vox	126: S&H Voc
027: Sky Light	077: Syn Vox	127: X-TlkBxBass
028: Stargate MC	078: Choir Aahs	128: X-Kick/TB
029: Middle Grow	079: Space Voice	
030: AiRye Bread	080: Star Voice	
031: NU-NRG Org	081: Brightness	
032: Halo Pad	082: Vox Lead	
033: Str/Brs Pad	083: Auhbient	
034: Syn Brs Pad	084: Auh Luv Rave	
035: Simple Pad	085: PCM Life	
036: OB Rezo Pad	086: Noisevox	
037: Sweet Vocode	087: Trance Voice	
038: Thin Pad	088: Effect Acer	
039: Attack Pad	089: Alternative	
040: Metal Pad	090: Hard Pure	
041: Atmosphere	091: Metal EF	
042: Fantasia	092: Dly Tone	
043: Feedbackwave	093: Osci Frog	
044: Pacifica	094: Cal + After	
045: Atmosphere 2	095: 8b Pad	
046: Sub Atmosphe	096: SpaceHighway	
047: Machine Pad	097: Trek Storm	
048: Detuned Pad	098: Abduction	
049: Scoop Pad	099: 1st Contact	
050: Psycho Trevor	100: Ice Cave	

Preset C (CC#0 = 81, CC#32 = 2)

No. Name	No. Name	No. Name
001: X-Org/Nz	051: Cheese Organ	101: Synth Brass3
002: X-Pizz/Rng	052: Reed Organ	102: Syn Brs Lead
003: White Noise	053: Telstar	103: Obilator
004: Pink Noise	054: Church Org	104: OpenUp Brass
005: P5 Noise	055: Organ Bass	105: Brass Fall
006: Toy Noise	056: Strict Organ	106: Trumpet
007: Rezo Noise	057: SmkyChrd Org	107: MutedTrumpet
008: Vinyl Noise	058: Sweep Organ	108: Soprano Sax
009: Tornado Jet	059: Accordion	109: Alto Sax
010: Smooth Jet	060: Vibraphone	110: Baritone Sax
011: Sweep Noise	061: FM Marimba	111: SlideBiteSax
012: ModWhtSweep	062: Marimba	112: Sax & Tp
013: Perk Breath	063: Xylophone	113: Tuba
014: Pink Bomb	064: Balaphone	114: Syn F.Horn
015: 64voicePiano	065: Timpani	115: Oboe
016: Ac.Piano 1	066: Steel Drum	116: Whistle
017: Ac.Piano 2	067: Digi Bell	117: Ocarina
018: Epic House	068: Acid Perc	118: Recorder
019: Hush Piano	069: MetaL-SD	119: Jazz SynLead
020: Happy Piano	070: Classy Pulse	120: Solo Flute
021: BPF Piano	071: Glockenspiel	121: Pan Flute
022: Honky-tonk	072: Fanta Bell	122: Bottle Blow
023: NY Piano+Str	073: Crystal	123: Funky Pipe
024: Voice Piano	074: Tubular-Bell	124: Breath Noise
025: Old E.Piano	075: Shank Bells	125: Shakuhachi
026: E.Piano 1	076: MKS-30 Melts	126: Sitar 1
027: E.Piano 2	077: Trip Lead	127: Sitar 2
028: Cool Rhodes	078: Steel-Str.Gt	128: Santur
029: Psycho EP	079: Clean Gtr	
030: Trip E.Piano	080: Jazz Gtr 1	
031: Rotary Rhode	081: Jazz Gtr 2	
032: EP-Organ	082: Muted Gtr	
033: Harpsichord	083: Lo-Fi Gtr	
034: Clavi	084: Terror Dome	
035: Digi Clavi	085: Psycho-G	
036: FM Clavi	086: Dist Gtr Chd	
037: AnalogClavi1	087: Going Bald	
038: AnalogClavi2	088: Gt.Harmonic1	
039: Funky Clavi	089: Gt.Harmonic2	
040: RotaryOrg Sl	090: Shafted Gtr	
041: RotaryOrg Fs	091: WahGT 2 Menu	
042: Gospel Spin	092: Gtr Up	
043: L Org F	093: Gtr Down	
044: Organ 1	094: Gtr Sweep	
045: Lp-Hp Organ	095: Orch Gtr	
046: Organ 2	096: Brass	
047: Percsv Organ	097: Bright Brass	
048: Ballad B	098: Hush Brass	
049: FM Club Org	099: Synth Brass1	
050: Pop Organ	100: Synth Brass2	

Preset D (CC#0 = 81, CC#32 = 3)

No.	Name	No.	Name	No.	Name
001:	Kalimba	057:	Slow Down	113:	CHH 1 Menu
002:	Bagpipes	058:	Boom Drop	114:	CHH 2 Menu
003:	PnoBendM7-m7	059:	B-Tom-D	115:	PHH Menu
004:	Org Chd m7	060:	Mr.Bong Bass	116:	OHH 1 Menu
005:	BalapChd 9th	061:	Friends of 0	117:	OHH 2 Menu
006:	Wah Gtr Hit	062:	Latin Perc	118:	Clap 1 Menu
007:	Orch Hit 1	063:	Bongo Fury	119:	Clap 2 Menu
008:	Orch Hit 2	064:	High Timbale	120:	Snare 1 Menu
009:	Rave-X-Tasy	065:	MutePandeiro	121:	Snare 2 Menu
010:	Philly Hit 1	066:	Open Surdo	122:	Snare 3 Menu
011:	Philly Hit 2	067:	Brazil Perc	123:	Snare 4 Menu
012:	Attack Hit	068:	Tablabaya	124:	Snare 5 Menu
013:	Funky Hit	069:	Mute Cuica	125:	Snare 6 Menu
014:	Tekno ChdHit	070:	Long Whistle	126:	Kick 1 Menu
015:	Dist Hit	071:	Agogo	127:	Kick 2 Menu
016:	Glasgow Hit	072:	Short Tamb	128:	Kick 3 Menu
017:	Happy Hit	073:	808 Cowbell		
018:	Scene Hit 1	074:	CR78 Cowbell		
019:	Scene Hit 2	075:	CR78 Beat		
020:	Drill Hit	076:	Wind-Chime		
021:	Gaia Message	077:	Rim Shot		
022:	Rezo Perc	078:	TR909 Rim		
023:	Syn Perc	079:	Hyoshigi		
024:	MG Blip	080:	TR626 Shaker		
025:	Rev Blip	081:	727 Quijada		
026:	Air Blip	082:	Real CH		
027:	Radical Perc	083:	TR909 OH		
028:	Machine	084:	Syn OH		
029:	Metal Hit	085:	TR909 Crash		
030:	Tanz Devil	086:	Reverse Cym.		
031:	Headz Direkt	087:	Asian Gong		
032:	ShoppingCart	088:	TR808 Clap		
033:	Noisy Drill	089:	Down Clap		
034:	Thump Bounce	090:	Clap Tail		
035:	Tape Rewind	091:	Rap&Real Clp		
036:	Stop	092:	Maddening		
037:	Ao!	093:	TR909 Snare		
038:	Ha!	094:	TR808 Snare		
039:	Seashore	095:	House Snare		
040:	Bird	096:	Jungle Snr 1		
041:	Telephone	097:	Jungle Snr 2		
042:	Helicopter	098:	TR808 Kick		
043:	Applause	099:	Plastic BD		
044:	Gun Shot	100:	Gate Kick		
045:	Machine Gun	101:	Jungle Kick		
046:	Laser Gun	102:	Scrtch/Vo Mn		
047:	Sci-Fi Laser	103:	Flexi Vox Mn		
048:	Breath	104:	Hit Menu		
049:	Rain	105:	Indust Menu		
050:	Siren	106:	Tom Menu		
051:	TR909 Tom	107:	Percus1 Menu		
052:	TR808 Tom	108:	Percus2 Menu		
053:	Syn Tom 1	109:	Cowbell Menu		
054:	Syn Tom 2	110:	Shaker+ Menu		
055:	Old Syn Tom	111:	Rim Menu		
056:	Taiko	112:	Cymbal Menu		

Bank Select table

Patch	CC#0	CC#32
Preset A	81	0
Preset B	81	1
Preset C	81	2
Preset D	81	3
User A	85	0
User B	85	1
Card A	86	0
Card B	86	1
Card C	86	2
Card D	86	3

Rhythm Set	CC#0	CC#32
Preset	81	0
User	85	0
Card	86	0

Patch transmit example

P:B016	[4th Saw]
CC#0	81
CC#32	1
PG#	16

Rhythm Set transmit example

P:12	[Jungle]
CC#0	81
CC#32	0
PG#	12

Preset Rhythm Set List

* The Rhythm Group column shows the button that can be pressed to mute that rhythm tone.

Note No.	Rhythm Group	P:01 TR-909	P:02 TR-808	P:03 TR-606	P:04 CR78&Cheaps
35	BD	Plastic BD 4	TR808 Kick 5	TR808 Kick 3	Toy Kick
C2 36	BD	Plastic BD 3	TR808 Kick 3	Analog Kick	Plastic BD 4
37	TOM/PERC	TR808 Rim	TR808 RimLng	TR808 Rim	TR808 Rim
38	SD	TR909 Snr 1	TR808 Snr 8	TR606 Snr 3	TR808 Snr 5
39	CLP	TR909 Clap 2	TR909 Clap 1	Cheap Clap	TR909 Clap 1
40	SD	TR909 Snr 3	TR808 Snr 9	TR808 Snr 5	Deep Snare
41	TOM/PERC	TR707 Tom	TR606 Tom	TR606 CmpTom	MG Blip
42	HH	TR909 CHH 2	TR808 CHH 2	TR606 CHH 2	TR808 CHH 1
43	TOM/PERC	TR707 Tom	TR606 Tom	TR606 CmpTom	MG Blip
44	HH	TR909 PHH 2	TR808 PHH 2	Hip PHH	TR606 PHH 2
45	TOM/PERC	TR707 Tom	TR606 Tom	TR606 CmpTom	MG Blip
46	HH	TR909 OHH 1	TR808 OHH 2	TR606 DstOHH	TR606 OHH
47	BD	TR909 Kick 4	TR808 Kick 1	TR606 Dst BD	TR606 Kick
C3 48	BD	TR909 Kick 2	TR808 Kick 4	TR606 Kick	Analog Kick
49	TOM/PERC	TR909 Rim	TR808 Rim	Analog Rim	Analog Rim
50	SD	TR909 Snr 2	TR808 Snr 6	TR606 Snr 2	TR808 Snr 1
51	CLP	TR909 Clap 1	TR808 Clap	TR808 Clap	TR808 Clap
52	SD	TR909 Snr 3	TR808 Snr 2	TR606 Snr 1	CR78 Snare
53	TOM/PERC	TR909 Tom	TR808 Tom	TR606 Tom	TR606 Tom
54	HH	TR909 CHH 1	TR808 CHH 1	TR606 CHH 1	DR55 CHH 1
55	TOM/PERC	TR909 Tom	TR808 Tom	TR606 Tom	TR606 Tom
56	HH	TR909 OHH 2	TR808 CHH 2	TR606 PHH 1	CR78 CHH
57	TOM/PERC	TR909 Tom	TR808 Tom	TR606 Tom	TR606 Tom
58	HH	TR909 OHH 2	TR808 OHH 1	TR606 OHH	CR78 OHH
59	TOM/PERC	TR909 Tom	TR808 Tom	TR606 Tom	TR606 Tom
C4 60	TOM/PERC	TR909 Tom	TR808 Tom	TR606 Tom	TR606 Tom
61	CYM	TR909 Crash	TR606 Cym 1	TR606 Cym 2	TR606 Cym 1
62	TOM/PERC	TR909 Tom	TR808 Tom	TR606 Tom	TR606 Tom
63	CYM	TR909 Ride	TR606 Cym 1	TR909 Ride	TR606 Cym 1
64	CYM	TR909 Crash	TR909 Crash	TR606 Cym 1	Cup Cym
65	CYM	TR909 Ride	TR909 Ride	TR707 Ride	TR909 Ride
66	TOM/PERC	Tambourine 2	CR78 Tamb	CR78 Tamb	CR78 Tamb
67	CYM	NaturalCrash	TR909 Crash	TR909 Crash	TR909 Crash
68	TOM/PERC	TR808Cowbell	TR808Cowbell	TR808Cowbell	CR78 Cowbell
69	CYM	TR606 Cym 1	TR909 Crash	TR909 Crash	TR909 Ride
70	TOM/PERC	PC-2 Machine	CR78 Guiro	CR78 Guiro	TR808Cowbell
71	CYM	Natural Ride	Natural Ride	Natural Ride	TR707 Ride
C5 72	TOM/PERC	HiBongo Open	TR808 Conga	TR808 Conga	TR808 Conga
73	TOM/PERC	LoBongo Open	TR808 Conga	TR808 Conga	TR808 Conga
74	TOM/PERC	HiConga Mute	TR808 Conga	TR808 Conga	TR808 Conga
75	TOM/PERC	HiConga Open	TR808 Conga	TR808 Conga	TR808 Conga
76	TOM/PERC	LoConga Open	TR808 Conga	TR808 Conga	TR808 Conga
77	TOM/PERC	Hi Timbale	Hi Timbale	Hi Timbale	CR78 Beat
78	TOM/PERC	Lo Timbale	Lo Timbale	Lo Timbale	CR78 Beat
79	TOM/PERC	TR727 Agogo	TR727 Agogo	CR78 Beat	TR727 Agogo
80	TOM/PERC	TR727 Agogo	TR808 Claves	CR78 Beat	TR727 Agogo
81	TOM/PERC	Cabasa Up	Cabasa Up	Cabasa Up	CR78 Guiro
82	TOM/PERC	808 Maracas	808 Maracas	808 Maracas	808 Maracas
83	HIT	Beam HiQ	Beam HiQ	Beam HiQ	Syn Hit
C6 84	HIT	Air Blip	Air Blip	Buzzer	Beam HiQ
85	HIT	MG Blip	Syn Hit	Air Blip	Analog Bird
86	HIT	Techno Scene	Techno Scene	Rezo Noise	MG Attack
87	HIT	Air Gun	Beam HiQ	Hyoshigi	Tape Rewind
88	HIT	Tekno Hit	PC-2 Machine	Analog Bird	Air Blip
89	OTHERS	Come on!	P5 Noise	Retro UFO	Reso FX
90	OTHERS	Wao!	Toy Gun 1	PC-2 Machine	Ring Osc
91	OTHERS	Ooh! 1	Syn Tom	Syn Hit	MG Blip
92	OTHERS	Canvas	Cup Cym	Retro UFO	MG White Nz
93	OTHERS	JP8000 FBK	TR808 OHH 1	Thrill	Rezo Noise
94	CLP	Funky Clap	Hip Clap	Comp Clap	Cheap Clap
95	BD	TR808 Kick 1	TR808 Kick 2	TR808 Kick 1	TR808 Kick 1
C7 96	BD	Gabba Kick	TR909 Kick 4	Plastic BD 4	TR909 Kick 1
97	SD	Synth Snare	CR78 Snare	TR909 Snr 3	TR909 Snr 1
98	SD	TR808 Snr 2	TR808 Snr 3	CR78 Snare	Sim Snare

Note No.	Rhythm Group	P:05 Techno 1	P:06 Techno 2	P:07 Techno 3	P:08 Hardcore
C2 35	BD	Plastic BD 3	TR808 Kick 5	Plastic BD 3	TR909 Kick 5
36	BD	Plastic BD 2	TR707 Kick 1	Plastic BD 4	Gabba Kick
37	TOM/PERC	TR707 Rim	TR909 Rim	Jungle Snr 2	SideStiker
38	SD	TR909 Snr 6	Real Snare	TR808 Snr 7	Jungle Snr 1
39	CLP	TR909 Clap 1	Down Clap	Comp Clap	Fuzzy Clap
40	SD	TR909 Snr 7	Rap Snare	Indus Snare	TR909 Snr 4
41	TOM/PERC	TR909 DstTom	TR808 Tom	Air Blip	TR606 CmpTom
42	HH	TR909 CHH 2	TR808 CHH 2	CHH MENU 2	TR909 CHH 2
43	TOM/PERC	TR909 DstTom	TR808 Tom	MG Blip	TR606 CmpTom
44	HH	TR909 PHH 1	TR808 PHH 1	Jungle Rim 2	TR909 PHH 1
45	TOM/PERC	TR909 DstTom	TR808 Tom	HIT MENU	TR606 CmpTom
46	HH	TR909 OHH 2	TR808 OHH 1	TR909 OHH 2	TR909 OHH 1
47	BD	TR909 Kick 5	TR909 Kick 2	KICK MENU 2	Amsterdam BD
C3 48	BD	TR909 Kick 4	Plastic BD 4	West Kick	TR909 Dst BD
49	TOM/PERC	TR909 Rim	TR808 RimLng	Natural Rim	Lo-Fi Rim
50	SD	TR909 Snr 4	TR909 Snr 4	TR808 Snr 8	TR909 DstSnr
51	CLP	Group Clap	Claptail	Comp Clap	Funk Clap 2
52	SD	TR909 Snr 5	Funky Clap	MC Snare	TR909 DstSnr
53	TOM/PERC	TR909 Tom	TR707 Tom	Uuh Formant	TR909 DstTom
54	HH	TR909 CHH 1	Closed Hat	TR606 PHH 2	TR909 PHH 1
55	TOM/PERC	TR909 Tom	TR707 Tom	Ooh Formant	TR909 DstTom
56	HH	TR909 PHH 2	TR909 OHH 2	CR78 CHH	TR909 PHH 2
57	TOM/PERC	TR909 Tom	TR707 Tom	lih Formant	TR909 DstTom
58	HH	TR909 OHH 3	TR909 OHH 2	TR606 OHH	TR909 DstOHH
59	TOM/PERC	TR909 Tom	TR707 Tom	Can Tom	TR909 DstTom
C4 60	TOM/PERC	TR909 Tom	TR707 Tom	ElectricDunk	TR909 DstTom
61	CYM	TR909 Crash	TR909 Crash	TR606 Cym 2	TR909 Crash
62	TOM/PERC	TR909 Tom	TR707 Tom	HiBongo LoFi	TR909 DstTom
63	CYM	TR707 Ride	TR707 Ride	CYMBAL MENU	TR707 Ride
64	CYM	TR909 Crash	TR909 Crash	Cup Cym	TR909 Crash
65	CYM	Asian Gong	Asian Gong	TR909 Ride	Asian Gong
66	TOM/PERC	Tambourine 3	Tambourine 2	Tambourine 4	CR78 Tamb
67	CYM	TR909 Crash	TR909 Crash	CYMBAL MENU	NaturalCrash
68	TOM/PERC	Cowbell	TR808Cowbell	CR78 Beat	TR808Cowbell
69	CYM	TR606 Cym 1	TR606 Cym 2	Natural Ride	Jungle Crash
70	TOM/PERC	TR808Cowbell	CR78 Tamb	CR78 Beat	TR727Quijada
71	CYM	Natural Ride	Cup Cym	Cup Cym	Natural Ride
C5 72	TOM/PERC	HiBongo LoFi	HiBongo Open	HiBongo LoFi	HiBongo LoFi
73	TOM/PERC	LoBongo LoFi	LoBongo Open	HiBongo LoFi	LoBongo LoFi
74	TOM/PERC	HiCnga Mt LF	HiConga Mute	HiBongo LoFi	HiCnga Mt LF
75	TOM/PERC	HiCnga Op LF	HiConga Open	HiCnga Mt LF	HiCnga Op LF
76	TOM/PERC	LoConga LoFi	LoConga Open	HiConga Mute	LoConga LoFi
77	TOM/PERC	HiTimbale LF	Hi Timbale	Triangle 2	HiTimbale LF
78	TOM/PERC	LoTimbale LF	Lo Timbale	ElectricDunk	LoTimbale LF
79	TOM/PERC	CR78 Beat	TR727 Agogo	Air Blip	TR727 Agogo
80	TOM/PERC	CR78 Beat	TR727 Agogo	MG Attack	TR727 Agogo
81	TOM/PERC	TechnoShaker	TechnoShaker	TechnoShaker	TechnoShaker
82	TOM/PERC	TR626 Shaker	Maracas	808 Maracas	Dance Shaker
83	HIT	Wao!	Beam HiQ	Reso FX	Beam HiQ
C6 84	HIT	Come on!	Techno Scene	Beam HiQ	Air Gun
85	HIT	Ooh! 1	Thin Beef	Toy Gun 3	ElectricDunk
86	HIT	MG White Nz	Come on!	MG Blip	Thin Beef
87	HIT	Bomb Noise	Ooh! 1	Toy Gun 3	Drill Hit
88	HIT	Wah Gtr 2b	Wao!	Air Blip	TAO Hit
89	OTHERS	Toy Gun 3	Analog Bird	Reso FX	Rezo Noise
90	OTHERS	Toy Gun 3	Retro UFO	Emergency	Toy Gun 1
91	OTHERS	Buzzer	Metal Sweep	MG Blip	Toy Gun 3
92	OTHERS	Bomb Noise	Emergency	MG Pink Nz	Gtr FX
93	OTHERS	Sea	Tonality	Jet Plane	Dist Synth
94	CLP	Flange Snr	TR909 Clap 1	Roll Snare	Funk Clap
95	BD	TR909 Dst BD	Wet Kick	TR808 Kick 1	TR909 Kick 2
C7 96	BD	Plastic BD 4	Hip Kick	TR909 Kick 1	Turbo Kick
97	SD	Break Snare2	TR909 Snr 5	TR909 Snr 1	Rage Snare
98	SD	Ragga Rim 2	Clap Snare 2	Urban RollSD	Big Trash SD

Note No.	Rhythm Group	P:09 Ambient	P:10 House 1	P:11 House 2	P:12 Jungle
35	BD	TR909 Kick 5	TR808 Kick 5	Wet Kick	TR909 Kick 3
36	BD	Wet Kick	TR909 Kick 2	Plastic BD 2	Lo-Fi Kick 2
37	TOM/PERC	Ragga Rim 1	TR808 Rim	TR808 Rim	SideStiker
38	SD	DJ Snare	SNR MENU 1	Clap Snare 2	Urban RollSD
39	CLP	Comp Clap	CLAP MENU 1	Group Clap	Down Clap
40	SD	SideStiker	TR909 Snr 6	TR808 Snr 7	Jungle Rim 1
41	TOM/PERC	TR707 Tom	TOM MENU	TR808 Tom	Jungle Snr 2
42	HH	Closed Hat	TR707 OHH	TR707 CHH	Tight CHH
43	TOM/PERC	TR707 Tom	TR909 Tom	TR808 Tom	Jungle Snr 2
44	HH	Pedal Hat 1	TR707 OHH	TR707 PHH	Tambourine 1
45	TOM/PERC	TR707 Tom	TR909 Tom	TR808 Tom	Jungle Snr 2
46	HH	Real OHH	TR707 OHH	TR707 OHH	Cym OHH
47	BD	Wet Kick	TR808 Kick 1	TR909 Kick 2	TR909 Kick 5
48	BD	TR808 Kick 3	TR909 Kick 3	TR909 Kick 5	JungleKick 2
49	TOM/PERC	TR808 RimLng	TR808 RimLng	TR909 Rim	Jungle Rim 2
50	SD	CR78 Snare	Break Snare2	Break Snare2	Urban Snare
51	CLP	TR909 Clap 1	Claptail	TR909 Clap 1	Jungle Rim 3
52	SD	Beam HiQ	TR909 Snr 4	TR909 Snr 4	Jungle Snr 1
53	TOM/PERC	TR808 Tom	TR808 Tom	TR707 Tom	TR606 CmpTom
54	HH	DR55 CHH 1	TR909 CHH 1	TR909 CHH 1	Real CHH
55	TOM/PERC	TR808 Tom	TR808 Tom	TR707 Tom	TR606 CmpTom
56	HH	TR606 PHH 2	OHH MENU 1	TR909 PHH 1	Jungle Hat
57	TOM/PERC	TR808 Tom	TR808 Tom	TR707 Tom	TR606 CmpTom
58	HH	CR78 OHH	OHH MENU 1	TR909 OHH 3	Hip OHH
59	TOM/PERC	TR808 Tom	TR707 Tom	TR707 Tom	TR606 CmpTom
60	TOM/PERC	TR808 Tom	TR707 Tom	TR707 Tom	TR606 CmpTom
61	CYM	TR606 Cym 1	TR909 Crash	TR909 Crash	Jungle Crash
62	TOM/PERC	TR808 Tom	TR707 Tom	TR707 Tom	TR606 CmpTom
63	CYM	TR909 Ride	TR909 Ride	TR909 Ride	Natural Ride
64	CYM	TR606 Cym 1	NaturalCrash	NaturalCrash	NaturalCrash
65	CYM	Asian Gong	Tambourine 2	Tambourine 3	Asian Gong
66	TOM/PERC	Tambourine 3	Tambourine 1	Tambourine 4	Tambourine 3
67	CYM	TR606 Cym 2	TR909 Crash	TR909 Crash	TR606 Cym 1
68	TOM/PERC	CR78 Cowbell	TR707Cowbell	TR707Cowbell	Cowbell
69	CYM	NaturalCrash	Cup Cym	Cup Cym	TR909 Crash
70	TOM/PERC	TR808Cowbell	TR808Cowbell	TR808Cowbell	CR78 Tamb
71	CYM	Natural Ride	Natural Ride	Natural Ride	TR707 Ride
72	TOM/PERC	HiBongo Open	HiBongo LoFi	HiBongo LoFi	HiBongo LoFi
73	TOM/PERC	LoBongo Open	LoBongo LoFi	LoBongo LoFi	LoBongo LoFi
74	TOM/PERC	HiConga Mute	HiConga Mute	HiCnga Mt LF	HiCnga Mt LF
75	TOM/PERC	HiConga Open	HiConga Open	HiCnga Op LF	HiCnga Op LF
76	TOM/PERC	LoConga Open	LoConga Open	LoConga LoFi	LoConga LoFi
77	TOM/PERC	Hi Timbale	HiTimbale LF	HiTimbale LF	HiTimbale LF
78	TOM/PERC	Lo Timbale	LoTimbale LF	LoTimbale LF	LoTimbale LF
79	TOM/PERC	TR727 Agogo	TR727 Agogo	TR727 Agogo	Open Surdo
80	TOM/PERC	TR727 Agogo	TR727 Agogo	TR727 Agogo	Mute Surdo
81	TOM/PERC	TechnoShaker	808 Maracas	Cabasa Ap	TechnoShaker
82	TOM/PERC	808 Maracas	TR626 Shaker	TR626 Shaker	TR626 Shaker
83	HIT	Air Blip	TR606 CHH 1	Belltree	Beam HiQ
84	HIT	Wind Chime	TR727Quijada	TR727Quijada	Air Blip
85	HIT	Thrill	Short Guiro	Short Guiro	Thin Beef
86	HIT	CR78 Beat	Long Guiro	Long Guiro	Analog Bird
87	HIT	Retro UFO	TR808 Claves	TR808 Claves	Tape Rewind
88	HIT	Hyoshigi	Hyoshigi	Hyoshigi	Wao!
89	OTHERS	Pizzy Techno	Bomb Noise	Bomb Noise	Emergency
90	OTHERS	Org Chord	Come on!	Come on!	Toy Gun 3
91	OTHERS	Feedbackwave	Triangle 1	Ooh! 1	Reso FX
92	OTHERS	Stream	Cup Cym	Wao!	Toy Gun 2
93	OTHERS	Bird	TR808 OHH 1	Laugh	Toy Gun 1
94	CLP	Claptail	Hip Clap	Claptail	Big Clap
95	BD	TR808 Kick 1	TR808 Kick 2	TR808 Kick 1	TR808 Kick 2
96	BD	JungleKick 2	TR909 Kick 4	Plastic BD 3	Roll Kick
97	SD	TR808 Snr 2	CR78 Snare	TR808 Snr 6	Roll Snare
98	SD	Jungle Snr 1	TR808 Snr 3	TR909 Snr 7	Break Snare2

Note No.	Rhythm Group	P:13 Drum'n'Bass1	P:14 Drum'n'Bass2	P:15 Hip-Hop 1	P:16 Hip-Hop 2
35	BD	Roll Kick	TR909 Kick 3	Lo-Fi Kick 1	TR707 Kick 1
C2 36	BD	Analog Kick	Lo-Fi Kick 2	TR808 Kick 3	Optic Kick
37	TOM/PERC	RaggaTightSD	SideStiker	Solid Snare	TR808 RimLng
38	SD	Cross Snare	Urban RollSD	HipJazz Snr	Headz Snare
39	CLP	Roll Snare	Down Clap	Funk Clap 2	Claptail
40	SD	Headz Snare	Jungle Snr 1	R&B Snare	TR808 Snr 7
	TOM/PERC	TR606 Tom	Jungle Snr 2	TR808 Tom	TR808 Tom
41	HH	Pop CHH	Tight CHH	Pop CHH	TR808 CHH 1
43	TOM/PERC	TR606 Tom	Jungle Snr 2	TR808 Tom	TR808 Tom
44	HH	Tambourine 3	Tambourine 1	Pedal Hat 1	TR808 PHH 1
45	TOM/PERC	TR606 Tom	Jungle Snr 2	TR808 Tom	TR808 Tom
46	HH	Pop Hat Open	Cym OHH	Pop Hat Open	TR808 OHH 2
47	BD	Plastic BD 1	TR909 Kick 5	Break Kick	TR909 Kick 3
C3 48	BD	Hip Kick	JungleKick 2	Hip Kick	TR808 Kick 3
49	TOM/PERC	Scratch SD r	Jungle Rim 2	Lo-Fi Rim	Gate Rim
50	SD	Break Snare2	Urban Snare	Jazz Snare	Tiny Snare 2
51	CLP	Funky Clap	Jungle Rim 3	Funky Clap	Little Clap
52	SD	Ragga Snr 2	Jungle Snr 1	East Snare	R&B Snare
	TOM/PERC	Kick Tom	TR909 DstTom	Natural Tom	Natural Tom
53	HH	Real CHH	Real CHH	Tight CHH	Pop CHH
55	TOM/PERC	Kick Tom	TR909 DstTom	Natural Tom	Natural Tom
56	HH	TR808 PHH 1	Jungle Hat	Pedal Hat 2	Pedal Hat 1
57	TOM/PERC	Kick Tom	TR909 DstTom	Natural Tom	Natural Tom
58	HH	TR606 OHH	Hip OHH	Hip OHH	Pop Hat Open
59	TOM/PERC	Kick Tom	TR909 DstTom	Natural Tom	Natural Tom
C4 60	TOM/PERC	Kick Tom	TR909 DstTom	Natural Tom	Natural Tom
61	CYM	TR909 Crash	Jungle Crash	TR909 Crash	NaturalCrash
62	TOM/PERC	Kick Tom	TR606 CmpTom	Natural Tom	Natural Tom
63	CYM	TR909 Ride	Natural Ride	TR707 Ride	TR909 Ride
64	CYM	TR909 Crash	NaturalCrash	TR909 Crash	TR909 Crash
	CYM	Asian Gong	Asian Gong	Cup Cym	Cup Cym
65	TOM/PERC	Tambourine 2	Tambourine 3	Tambourine 3	Tambourine 4
67	CYM	TR909 Crash	TR606 Cym 1	Tambourine 4	TR909 Crash
68	TOM/PERC	CR78 Cowbell	Cowbell	TR808Cowbell	Cowbell
69	CYM	TR606 Cym 2	TR909 Crash	TR606 Cym 1	TR606 Cym 1
70	TOM/PERC	TR808Cowbell	CR78 Tamb	CR78 Cowbell	TR808Cowbell
71	CYM	Natural Ride	TR707 Ride	Natural Ride	Natural Ride
C5 72	TOM/PERC	HiBongo Open	HiBongo LoFi	HiBongo LoFi	HiBongo Open
73	TOM/PERC	LoBongo Open	LoBongo LoFi	LoBongo LoFi	LoBongo Open
74	TOM/PERC	HiConga Mute	HiCnga Mt LF	HiCnga Mt LF	HiConga Mute
75	TOM/PERC	HiConga Open	HiCnga Op LF	HiCnga Op LF	HiConga Open
76	TOM/PERC	LoConga Open	LoConga LoFi	LoConga LoFi	LoConga Open
	TOM/PERC	Hi Timbale	HiTimbale LF	HiTimbale LF	Hi Timbale
77	TOM/PERC	Lo Timbale	LoTimbale LF	LoTimbale LF	Lo Timbale
79	TOM/PERC	TR727 Agogo	Open Surdo	TR727 Agogo	TR727 Agogo
80	TOM/PERC	TR727 Agogo	Mute Surdo	TR727 Agogo	TR727 Agogo
81	TOM/PERC	Cabasa Up	Cabasa Up	Dance Shaker	TechnoShaker
82	TOM/PERC	Maracas	Maracas	808 Maracas	808 Maracas
83	HIT	MG Blip	Beam HiQ	Scratch BD f	Scratch BD f
C6 84	HIT	Air Blip	ElectricDunk	Scratch BD r	Scratch BD r
85	HIT	Hyoshigi	Bomb	Scratch SD f	Scratch SD f
86	HIT	CR78 Guiro	Analog Bird	Scratch SD r	Scratch SD r
87	HIT	Mt Pandeiro	Tape Rewind	Scratch ALT	Scratch ALT
88	HIT	Chenchen	Wao!	Vinyl Stop	Funky Bass
	OTHERS	Thrill	Emergency	Vinyl Noise	Vinyl Noise
89	OTHERS	Retro UFO	Toy Gun 3	Kick it!	Philly Hit
91	OTHERS	Rezo Noise	Reso FX	Ooh! 2	Brass Fall
92	OTHERS	Feedbackwave	Toy Gun 2	Ooh! 1	Ooh! 1
93	OTHERS	Space Noise	Toy Gun 1	Laugh	Ooh! 2
94	CLP	Little Clap	Big Clap	Funk Clap	Finger Snap
95	BD	TR808 Kick 2	TR808 Kick 2	TR808 Kick 1	TR808 Kick 1
C7 96	BD	TR909 Kick 1	Roll Kick	Dance Kick 1	Hazy Kick
97	SD	Solid Snare	Roll Snare	Break Snare2	TR606 Snr 2
98	SD	Flange Snr	Break Snare2	HH Soul Snr	Machine Snr

Note No.	Rhythm Group	P:17 Funk	P:18 Electro	P:19 Jazz	P:20 Brush
35	BD	TR707 Kick 2	TR808 Kick 1	Lo-Fi Kick 1	Video Kick
C2 36	BD	West Kick	TR808 Kick 5	Hip Kick	West Kick
37	TOM/PERC	Lo-Fi Rim	TR808 RimLng	SideStiker	Natural Rim
38	SD	Deep Snare	TR808 Snr 8	Deep Snare	R&B Snare
39	CLP	Funky Clap	Down Clap	Real Clap 1	Brush Slap 1
40	SD	Disco Snare	TR808 Snr 5	HH Soul Snr	MC Snare
41	TOM/PERC	TR707 Tom	TR808 Tom	Natural Tom	TR707 Tom
42	HH	Tight CHH	TR808 CHH 1	Real CHH	Pop CHH
43	TOM/PERC	TR707 Tom	TR808 Tom	Natural Tom	TR707 Tom
44	HH	Hip PHH	TR808 PHH 1	Pedal Hat 1	Room CHH
45	TOM/PERC	TR707 Tom	TR808 Tom	Natural Tom	TR707 Tom
46	HH	Funk OHH	TR808 OHH 1	Real OHH	Pop Hat Open
47	BD	Hazy Kick	Ele Kick	Optic Kick	Hip Kick
C3 48	BD	Turbo Kick	TR707 Kick 2	Video Kick	Optic Kick
49	TOM/PERC	SideStiker	TR707 Rim	Gate Rim	R8 BrshSwill
50	SD	Whack Snare	ElectroSnr 2	Headz Snare	R8 Brush Tap
51	CLP	Funk Clap 2	TR707 Clap	Big Clap	Brush Slap 2
52	SD	Macho Snare	Sim Snare	Cross Snare	R8 BrushRoll
53	TOM/PERC	TR909 Tom	Deep Tom	TR707 Tom	Natural Tom
54	HH	Real CHH	Closed Hat	Closed Hat	R8 Brush CHH
55	TOM/PERC	TR909 Tom	Deep Tom	TR707 Tom	Natural Tom
56	HH	Pedal Hat 1	Pedal Hat 1	Bristol CHH	Pedal Hat 1
57	TOM/PERC	TR909 Tom	Deep Tom	TR707 Tom	Natural Tom
58	HH	Cym OHH	Open Hat	Cym OHH	R8 OHH
59	TOM/PERC	TR909 Tom	Deep Tom	TR707 Tom	Natural Tom
C4 60	TOM/PERC	TR909 Tom	Deep Tom	TR707 Tom	Natural Tom
61	CYM	NaturalCrash	TR909 Crash	NaturalCrash	NaturalCrash
62	TOM/PERC	TR909 Tom	Deep Tom	TR707 Tom	Natural Tom
63	CYM	TR909 Ride	TR707 Ride	TR909 Ride	TR909 Ride
64	CYM	TR909 Crash	NaturalCrash	NaturalCrash	NaturalCrash
65	CYM	Cup Cym	Asian Gong	Cup Cym	Cup Cym
66	TOM/PERC	CR78 Tamb	Tambourine 2	Tambourine 2	Tambourine 2
67	CYM	TR909 Crash	TR909 Crash	TR909 Crash	TR606 Cym 1
68	TOM/PERC	TR707Cowbell	TR808Cowbell	Cowbell	Cowbell
69	CYM	TR606 Cym 1	TR606 Cym 1	TR606 Cym 1	TR909 Crash
70	TOM/PERC	TR808Cowbell	TR727Quijada	TR808Cowbell	TR808Cowbell
71	CYM	Natural Ride	Natural Ride	Natural Ride	Natural Ride
C5 72	TOM/PERC	HiBongo Open	HiBongo Open	HiBongo Open	HiBongo Open
73	TOM/PERC	LoBongo Open	LoBongo Open	LoBongo Open	LoBongo Open
74	TOM/PERC	HiConga Mute	HiConga Mute	HiConga Mute	HiConga Mute
75	TOM/PERC	HiConga Open	HiConga Open	HiConga Open	HiConga Open
76	TOM/PERC	LoConga Open	LoConga Open	LoConga Open	LoConga Open
77	TOM/PERC	Hi Timbale	Hi Timbale	Hi Timbale	Hi Timbale
78	TOM/PERC	Lo Timbale	Lo Timbale	Lo Timbale	Lo Timbale
79	TOM/PERC	TR727 Agogo	TR727 Agogo	TR727 Agogo	TR727 Agogo
80	TOM/PERC	TR727 Agogo	TR727 Agogo	TR727 Agogo	TR727 Agogo
81	TOM/PERC	TechnoShaker	Cabasa Up	Cabasa Up	Cabasa Up
82	TOM/PERC	808 Maracas	808 Maracas	Maracas	Maracas
83	HIT	Scratch BD f	Air Blip	TR727Quijada	Whistle
C6 84	HIT	Scratch BD r	Thin Beef	Jingle Bell	Whistle
85	HIT	Scratch SD f	Back Hit	Short Guiro	Short Guiro
86	HIT	Scratch SD r	Analog Bird	Long Guiro	Long Guiro
87	HIT	Scratch ALT	Hoo	TR808 Claves	TR808 Claves
88	HIT	Vinyl Stop	Metal Sweep	Hyoshigi	Hyoshigi
89	OTHERS	Vinyl Noise	Emergency	Hyoshigi	Hyoshigi
90	OTHERS	Philly Hit	Buzzer	Mute Cuica	Mute Cuica
91	OTHERS	Brass Fall	Tonality	Open Cuica	Open Cuica
92	OTHERS	Kick it!	Ring Osc	Triangle 1	Triangle 1
93	OTHERS	Harmo Gtr	Toy Gun 3	Triangle 1	Triangle 1
94	CLP	Big Clap	Hip Clap	Finger Snap	Real Clap 1
95	BD	Plastic BD 2	Plastic BD 1	TR808 Kick 1	TR909 Kick 2
C7 96	BD	TR909 Kick 5	Lo-Fi Kick 1	TR909 Kick 1	TR707 Kick 1
97	SD	DanceHall SD	Synth Snare	R8 BrshSwill	Real Snare
98	SD	Machine Snr	TR808 Snr 6	R8 Brush Tap	Deep Snare

Note No.	Rhythm Group	P:21 Disco	P:22 Ragga	P:23 Rock	P:24 Industrial
C2 35	BD	TR707 Kick 2	Analog Kick	Optic Kick	TR909 Dst BD
36	BD	TR808 Kick 3	TR707 Kick 2	TR909 Kick 4	Lo-Fi Kick 2
37	TOM/PERC	TR707 Rim	Gate Rim	TR808 RimLng	Drill Hit
38	SD	Real Snare	Jungle Rim 1	Hash Snare	Big Trash SD
39	CLP	Real Clap 1	Hip Clap	Funk Clap 2	Dist Swish
40	SD	Fat Snare	Ragga Snr 2	DJ Snare	Rage Snare
41	TOM/PERC	TR707 Tom	TR808 Tom	Kick Tom	Can Tom
42	HH	Real CHH	Bristol CHH	TR909 CHH 2	Air Blip
43	TOM/PERC	TR707 Tom	TR808 Tom	Kick Tom	Can Tom
44	HH	Pedal Hat 1	Pedal Hat 1	TR909 PHH 1	Beam HiQ
45	TOM/PERC	TR707 Tom	TR808 Tom	Kick Tom	Can Tom
46	HH	Real OHH	Cym OHH	TR909 OHH 1	TR909 DstOHH
47	BD	Turbo Kick	Plastic BD 4	TR909 Kick 5	Bomb
C3 48	BD	TR707 Kick 1	Video Kick	Turbo Kick	Iron Door
49	TOM/PERC	TR808 RimLng	Beam HiQ	SideStiker	Thrill
50	SD	Deep Snare	DanceHall SD	Lo-Fi Snare	PCM Press
51	CLP	Big Clap	Little Clap	Claptail	Air Gun
52	SD	TR707 Snare	Ragga Rim 2	Macho Snare	PCM Press
53	TOM/PERC	Deep Tom	Deep Tom	TR707 Tom	TekRok Snare
54	HH	TR808 CHH 1	TR707 CHH	TR909 PHH 1	Real PHH
55	TOM/PERC	Kick Tom	Deep Tom	TR707 Tom	TekRok Snare
56	HH	Pop CHH	Pop CHH	TR909 OHH 3	TR909 PHH 1
57	TOM/PERC	Deep Tom	Deep Tom	TR707 Tom	TekRok Snare
58	HH	TR707 OHH	TR707 OHH	Cym OHH	TR909 DstOHH
59	TOM/PERC	Kick Tom	Deep Tom	TR707 Tom	TekRok Snare
C4 60	TOM/PERC	Deep Tom	Deep Tom	TR707 Tom	TekRok Snare
61	CYM	NaturalCrash	NaturalCrash	TR909 Crash	Bomb Noise
62	TOM/PERC	Kick Tom	Deep Tom	TR707 Tom	TekRok Snare
63	CYM	TR909 Ride	TR909 Ride	TR909 Ride	TR909 Ride
64	CYM	NaturalCrash	NaturalCrash	TR909 Crash	Drill Hit
65	CYM	Cup Cym	Asian Gong	Asian Gong	ElectricDunk
66	TOM/PERC	Tambourine 2	Tambourine 3	Tambourine 3	Mt Pandeiro
67	CYM	TR909 Crash	TR909 Crash	TR909 Crash	TR606 Cym 1
68	TOM/PERC	Cowbell	Cowbell	Cowbell	PC-2 Machine
69	CYM	TR606 Cym 1	TR606 Cym 1	TR606 Cym 2	TR909 Crash
70	TOM/PERC	TR808Cowbell	TR808Cowbell	TR808Cowbell	Crash
71	CYM	Natural Ride	TR707 Ride	Natural Ride	Natural Ride
C5 72	TOM/PERC	HiBongo Open	HiBongo Open	HiBongo LoFi	HiBongo LoFi
73	TOM/PERC	LoBongo Open	LoBongo Open	LoBongo LoFi	LoBongo LoFi
74	TOM/PERC	HiConga Mute	HiConga Mute	HiCnga Mt LF	HiCnga Mt LF
75	TOM/PERC	HiConga Open	HiConga Open	HiCnga Op LF	HiCnga Op LF
76	TOM/PERC	LoConga Open	LoConga Open	LoConga LoFi	LoConga LoFi
77	TOM/PERC	Hi Timbale	Hi Timbale	HiTimbale LF	HiTimbale LF
78	TOM/PERC	Lo Timbale	Lo Timbale	LoTimbale LF	LoTimbale LF
79	TOM/PERC	TR727 Agogo	TR727 Agogo	TR727 Agogo	Analog Bird
80	TOM/PERC	TR727 Agogo	TR727 Agogo	TR727 Agogo	Analog Bird
81	TOM/PERC	Cabasa Up	TechnoShaker	TR727Quijada	TechnoShaker
82	TOM/PERC	Maracas	808 Maracas	TR626 Shaker	TR626 Shaker
83	HIT	Triangle 1	MG Attack	Bounce	One!
C6 84	HIT	Triangle 1	Air Blip	ElectricDunk	Two!
85	HIT	Beam HiQ	Syn Hit	Iron Door	Three!
86	HIT	Back Hit	TAO Hit	Drill Hit	Kick it!
87	HIT	Back Hit	Chiki!	Thrill	Wao!
88	HIT	Philly Hit	Hey!	PCM Press	Come on!
89	OTHERS	Brass Fall	Toy Gun 1	Dist TekGtr	Fuzzy Clap
90	OTHERS	Rezo Noise	Toy Gun 2	Dist TekGtr	Roll Kick
91	OTHERS	lih Formant	Toy Gun 3	Dist TekGtr	Bomb
92	OTHERS	Analog Bird	Reso FX	Dist TekGtr	LoTimbale LF
93	OTHERS	Emergency	Emergency	Gtr FX	TR909 DstOHH
94	CLP	Down Clap	Big Clap	Air Gun	Fuzzy Clap
95	BD	TR808 Kick 1	TR808 Kick 1	TR909 Kick 2	TR909 Kick 2
C7 96	BD	TR909 Kick 1	TR909 Kick 1	Gabba Kick	Roll Kick
97	SD	TR909 Snr 3	HH Soul Snr	ElectroSnr 2	TR909 DstSnr
98	SD	TR808 Snr 5	TR909 Snr 4	Big Trash SD	Flange Snr

Note No.	Rhythm Group	P:25 Ethnic	P:26 Reverse
35	BD	Open Surdo	Ele Kick
36	BD	Mute Surdo	Turbo Kick
C2 37	TOM/PERC	Jungle Snap	TR909 Rim
38	SD	Natural Rim	TR606 Snr 2
39	CLP	Big Clap	Comp Clap
40	SD	Jungle Snr 1	Real Snare
41	TOM/PERC	Jungle Snr 2	Can Tom
42	HH	Mt Pandeiro	TR808 CHH 2
43	TOM/PERC	Jungle Snr 2	Can Tom
44	HH	R8 Brush CHH	TR808 PHH 1
45	TOM/PERC	Jungle Snr 2	Can Tom
46	HH	Metal Sweep	TR808 OHH 1
47	BD	Afro Feet	TR707 Kick 1
C3 48	BD	Mute Surdo	Plastic BD 3
49	TOM/PERC	Jungle Snap	TR707 Rim
50	SD	Op Pandeiro	TR909 Snr 4
51	CLP	Real Clap 2	TR707 Clap
52	SD	Hi Timbale	Comp Clap
53	TOM/PERC	TablaBaya	TR707 Tom
54	HH	Chenchen	TR909 CHH 1
55	TOM/PERC	TablaBaya	TR707 Tom
56	HH	Tambourine 1	TR909 PHH 1
57	TOM/PERC	TablaBaya	TR707 Tom
58	HH	Tambourine 4	TR909 DstOHH
59	TOM/PERC	TablaBaya	TR707 Tom
C4 60	TOM/PERC	Udo	TR707 Tom
61	CYM	Asian Gong	TR909 Crash
62	TOM/PERC	Udo	TR707 Tom
63	CYM	Cup Cym	TR707 Ride
64	CYM	NaturalCrash	TR909 Crash
65	CYM	Cup Cym	Asian Gong
66	TOM/PERC	Tambourine 2	Tambourine 2
67	CYM	TR606 Cym 1	TR909 Crash
68	TOM/PERC	Cowbell	TR808Cowbell
69	CYM	NaturalCrash	TR606 Cym 2
70	TOM/PERC	CR78 Beat	CR78 Tamb
71	CYM	Natural Ride	Cup Cym
C5 72	TOM/PERC	HiBongo LoFi	HiBongo Open
73	TOM/PERC	LoBongo LoFi	LoBongo Open
74	TOM/PERC	HiCnga Mt LF	HiConga Mute
75	TOM/PERC	HiCnga Op LF	HiConga Open
76	TOM/PERC	LoConga LoFi	LoConga Open
77	TOM/PERC	HiTimbale LF	Hi Timbale
78	TOM/PERC	LoTimbale LF	Lo Timbale
79	TOM/PERC	TR727 Agogo	TR727 Agogo
80	TOM/PERC	TR727 Agogo	TR727 Agogo
81	TOM/PERC	Cabasa Up	TechnoShaker
82	TOM/PERC	TR626 Shaker	Maracas
83	HIT	Whistle	Beam HiQ
C6 84	HIT	Whistle	Tape Rewind
85	HIT	Short Guiro	Vinyl Stop
86	HIT	Long Guiro	Come on!
87	HIT	TR808 Claves	One!
88	HIT	Hyoshigi	Pa!
89	OTHERS	AfroDrum Rat	Analog Bird
90	OTHERS	Mute Cuica	Retro UFO
91	OTHERS	Open Cuica	Metal Sweep
92	OTHERS	Triangle 2	Dst Solo Gtr
93	OTHERS	Triangle 1	Emergency
94	CLP	Real Clap 1	Down Clap
95	BD	Boost Kick	Wet Kick
C7 96	BD	Kick Ghost	Hip Kick
97	SD	Voice loop	TR909 Snr 5
98	SD	Chiki!	Jazz Snare

Preset Pattern List

The sounds, phrases and patterns contained in this product are sound recordings protected by copyright. Roland hereby grants to purchasers of this product the permission to utilize the sound recordings contained in this product for the creation and recording of original musical works; provided however, the sound recordings contained in this product may not be sampled, downloaded or otherwise re-recorded, in whole or in part, for any other purpose, including but not limited to the transmission of all or any part of the sound recordings via the internet or other digital or analog means of transmission, and/or the manufacture, for sale or otherwise, of any collection of sampled sounds, phrases or patterns, on CD-ROM or equivalent means.

The sound recordings contained in this product are the original works of Roland Corporation. Roland is not responsible for the use of the sound recordings contained in this product, and assumes no liability for any infringement of any copyright of any third party arising out of use of the sounds, phrases and patterns in this product.

Techno

No.	Name	BPM	Measures	Mute	Programmer
P:001	Psy Trance 1	142	4	3,6,7	MASA
P:002	Psy Trance 2	145	4	4,5,7	MASA
P:003	Psy Trance 3	145	4	3,4,7	MASA
P:004	Psy Trance 4	145	4	4,6,7	MASA
P:005	Psy Trance 5	138	4	5,6,7	MASA
P:006	Psy Trance 6	142	4	3,4	MASA
P:007	Psy Trance 7	144	4	3,4,7	MASA
P:008	Psy Trance 8	143	4	4,6,7	MASA
P:009	Psy Trance 9	145	4	3,6,7	MASA
P:010	Psy Trance 10	145	4	4,6	MASA
P:011	Psy Trance 11	145	4	4,6	MASA
P:012	Psy Trance 12	142	4	5,6,7	MASA
P:013	Psy Trance 13	143	4	3,6,7	MASA
P:014	Psy Trance 14	145	4	5,6	MASA
P:015	Psy Trance 15	135	4	3,7	MASA
P:016	Psy Trance 16	142	4	5	MASA
P:017	Psy Trance 17	147	4	4,6	MASA
P:018	Psy Trance 18	141	4	5,6	MASA
P:019	Trance 1	146	4	6,7	MASA
P:020	Trance 2	136	8	CY	DJ Q'HEY
P:021	Trance 3	138	4	3,4,CY	DJ Q'HEY
P:022	Trance 4	140	8		DJ Q'HEY
P:023	Trance 5	145	4	3,4,6	MASA
P:024	Trance 6	119	4	4,5,7	MASA
P:025	Trance 7	129	4	4,5,7	MASA
P:026	Trance 8	129	4	7	MASA
P:027	Trance 9	130	8	3,7,CY,TP	YOJI BIOMEHANIKA
P:028	NU-NRG 1	150	2	5	YOJI BIOMEHANIKA
P:029	NU-NRG 2	152	2	3,5,7	YOJI BIOMEHANIKA
P:030	NU-NRG 3	145	8	6,7,SD,CY	YOJI BIOMEHANIKA
P:031	NU-NRG 4	150	8	3,5,TP	YOJI BIOMEHANIKA
P:032	NU-NRG 5	140	8	4	YOJI BIOMEHANIKA
P:033	NU-NRG 6	152	8	5,6	YOJI BIOMEHANIKA
P:034	Epic Trance 1	150	4	3,5	YOJI BIOMEHANIKA
P:035	Epic Trance 2	148	8	6,CY	YOJI BIOMEHANIKA
P:036	Epic Trance 3	148	8	3	YOJI BIOMEHANIKA
P:037	Minimal 1	135	8	2	DJ Q'HEY
P:038	Minimal 2	140	4	4	DJ Q'HEY
P:039	Minimal 3	135	4	SD, TP	HEIGO TANI
P:040	Minimal 4	135	4	5,CY	DJ Q'HEY
P:041	Minimal 5	130	2	TP	DJ Q'HEY
P:042	Minimal 6	138	4	2,CYM,TP	DJ Q'HEY
P:043	Minimal 7	132	4	SD,CY	DJ Q'HEY
P:044	Minimal 8	140	16		DJ Q'HEY

No.	Name	BPM	Measures	Mute	Programmer
P:045	Minimal 9	135	4		DJ Q'HEY
P:046	Minimal 10	140	4	5	DJ Q'HEY
P:047	Minimal 11	135	4	4,TP	DJ Q'HEY
P:048	Minimal 12	138	4	4,CY	DJ Q'HEY
P:049	DetroitTechno 1	132	4	6	HEIGO TANI
P:050	DetroitTechno 2	150	4	3	HEIGO TANI
P:051	DetroitTechno 3	140	4	3,CY	HEIGO TANI
P:052	DetroitTechno 4	132	4	4	DJ Q'HEY
P:053	DetroitTechno 5	136	8	3	HEIGO TANI
P:054	DetroitTechno 6	140	4	6	HEIGO TANI
P:055	Gabba 1	200	2	4,6,HI	HEIGO TANI
P:056	Gabba 2	200	4	3,5	HEIGO TANI
P:057	Gabba 3	180	4	4	HEIGO TANI
P:058	Gabba 4	167	4	3,5	MASA
P:059	Gabba 5	167	4	5,6	MASA
P:060	HappyHardcore 1	175	4	5	YOJI BIOMEHANIKA
P:061	HappyHardcore 2	190	4	5,7,CY	YOJI BIOMEHANIKA
P:062	HappyHardcore 3	175	2	3,4	YOJI BIOMEHANIKA
P:063	HappyHardcore 4	175	4	3,7	YOJI BIOMEHANIKA
P:064	HappyHardcore 5	175	2	3,7	YOJI BIOMEHANIKA
P:065	Rave 1	130	8	7	Roland Corporation
P:066	Rave 2	130	8	5	Roland Corporation
P:067	Rave 3	179	8	3	Ryeland Alison
P:068	Rave 4	179	8	5	Ryeland Alison
P:069	Rave 5	172	8	6	Ryeland Alison
P:070	Rave 6	185	8		Ryeland Alison
P:071	Rave 7	170	8	TP	Ryeland Alison
P:072	Dream Pop 1	145	4	4,6	YOJI BIOMEHANIKA
P:073	Dream Pop 2	130	8	4,6	YOJI BIOMEHANIKA
P:074	Dream Pop 3	140	8	5	YOJI BIOMEHANIKA
P:075	Rock 1	132	4	5,CY,OT	HEIGO TANI
P:076	Rock 2	130	4	3,CY	HEIGO TANI
P:077	Rock 3	137	4	67,CY	MASA
P:078	Rock 4	126	4	3,4	MASA
P:079	Rock 5	137	4	4,6,7	MASA
P:080	Rock 6	128	8	6	Vince LaDuca
P:081	Rock 7	112	4	4	Vince LaDuca
P:082	Rock 8	128	4	5,6	Vince LaDuca
P:083	Industrial 1	125	4	3,6	HEIGO TANI
P:084	Industrial 2	132	8	CL,TP	DJ Q'HEY
P:085	Industrial 3	112	4	5,7	MASA
P:086	Industrial 4	90	8	4,5	HEIGO TANI
P:087	Industrial 5	128	4	5,6	MASA
P:088	Industrial 6	128	4	5,6	MASA
P:089	Industrial 7	128	4	5,6	MASA
P:090	Industrial 8	128	4	6,7	MASA
P:091	Electro 1	122	4	6	Roland Corporation
P:092	Electro 2	119	8	4	A • L • M • A
P:093	AmbientTechno 1	130	8	BD	HEIGO TANI
P:094	AmbientTechno 2	120	16		DJ Q'HEY
P:095	AmbientTechno 3	120	16		DJ Q'HEY
P:096	AmbientTechno 4	128	4	4,5,7	MASA
P:097	AmbientTechno 5	120	4	3,4,5	MASA
P:098	AmbientTechno 6	120	4	4,6,CY	MASA

Drum'n'Bass

No.	Name	BPM	Measures	Mute	Programmer
P:099	Artcore 1	165	8	5	DJ khuv
P:100	Artcore 2	170	8	CL	Roland Corporation
P:101	Artcore 3	165	16		DJ khuv
P:102	Artcore 4	165	8	5	DJ khuv
P:103	Artcore 5	158	16		DJ Q'HEY
P:104	Drum'n'Bass 1	165	8	4	DJ khuv
P:105	Drum'n'Bass 2	156	4	5,6,7	MASA
P:106	Drum'n'Bass 3	156	8	4,6,7	MASA
P:107	Drum'n'Bass 4	180	16	5	DJ khuv
P:108	Drum'n'Bass 5	180	16	5	DJ khuv
P:109	Drum'n'Bass 6	165	8	4	DJ khuv
P:110	Darkcore 1	195	8	3	Ryeland Alison
P:111	Darkcore 2	160	4	3	DJ Q'HEY
P:112	Darkcore 3	161	8	3	DJ khuv
P:113	Darkcore 4	148	4	4,6	MASA
P:114	Darkcore 5	185	8	4	Ryeland Alison
P:115	Darkcore 6	185	8	4	Ryeland Alison
P:116	Hard Step 1	179	8	3	Ryeland Alison
P:117	Hard Step 2	165	8	4	DJ khuv
P:118	Hard Step 3	160	4	6	Vince LaDuca
P:119	Hard Step 4	190	8	4	Ryeland Alison
P:120	Tech Step 1	165	8		Ryeland Alison
P:121	Tech Step 2	165	8	3	Ryeland Alison
P:122	Tech Step 3	157	8	6	Ryeland Alison
P:123	Jazz Step 1	156	4	6,7	MASA
P:124	Jazz Step 2	160	8	5,6	Vince LaDuca
P:125	Jazz Step 3	165	8	4	Ryeland Alison
P:126	Jazz Step 4	197	8		Ryeland Alison
P:127	Jazz Step 5	170	8		Ryeland Alison
P:128	Ragga/Jungle 1	180	8	4	Ryeland Alison
P:129	Ragga/Jungle 2	179	8	4	Ryeland Alison
P:130	Ragga/Jungle 3	163	8	4	DJ khuv
P:131	Ragga/Jungle 4	165	8		Ryeland Alison
P:132	Ragga/Jungle 5	200	8	5	Ryeland Alison

Hip Hop

No.	Name	BPM	Measures	Mute	Programmer
P:133	HipHop East 1	93	2		DJ KENT
P:134	HipHop East 2	93	2		DJ KENT
P:135	HipHop East 3	95	4		DJ KENT
P:136	HipHop East 4	95	2		DJ KENT
P:137	HipHop East 5	95	2	5	DJ KENT
P:138	HipHop East 6	95	2		DJ KENT
P:139	HipHop East 7	84	8	7	A • L • M • A
P:140	HipHop East 8	85	4		A • L • M • A
P:141	HipHop East 9	89	2		DJ KENT
P:142	HipHop East 10	89	4	4	DJ KENT
P:143	HipHop West 1	99	2		DJ KENT
P:144	HipHop West 2	99	4	5	DJ KENT
P:145	HipHop West 3	95	4		DJ KENT
P:146	HipHop West 4	96	4	6,7	Vince LaDuca
P:147	HipHop West 5	89	4	3,5	Vince LaDuca
P:148	HipHop West 6	96	4		DJ KENT
P:149	HipHop West 7	92	2		DJ KENT
P:150	HipHop West 8	92	2	5	DJ KENT
P:151	HipHop West 9	92	2	6	DJ KENT

No.	Name	BPM	Measures	Mute	Programmer
P:152	Abstract 1	79	2	3	DJ KENT
P:153	Abstract 2	77	4	4,6	A • L • M • A
P:154	Abstract 3	79	2	3	DJ KENT
P:155	Abstract 4	94	4	5	Vince LaDuca
P:156	Abstract 5	94	4	4	Vince LaDuca
P:157	Abstract 6	92	4	4,5	Vince LaDuca
P:158	Abstract 7	67	2	6,7	A • L • M • A
P:159	Abstract 8	105	4	7	Vince LaDuca
P:160	Abstract 9	104	4	4,5,7	Vince LaDuca
P:161	Abstract 10	77	4		Vince LaDuca
P:162	Abstract 11	100	4	2,5,6,7	Vince LaDuca
P:163	HipHop Early 1	107	8	CY,OT	A • L • M • A
P:164	HipHop Early 2	98	4	7	A • L • M • A
P:165	HipHop Early 3	103	8		A • L • M • A
P:166	HipHop Early 4	98	8	6	A • L • M • A
P:167	HipHop Early 5	106	8	6	A • L • M • A
P:168	HipHop Early 6	100	2		DJ KENT
P:169	HipHop Early 7	87	2		DJ KENT
P:170	HipHop Early 8	99	2		DJ KENT
P:171	NewJack Swing 1	105	8	5	A • L • M • A
P:172	NewJack Swing 2	110	4	6	A • L • M • A
P:173	Miami Bass 1	138	8	7	A • L • M • A
P:174	Miami Bass 2	127	4	5	A • L • M • A
P:175	HipHop Jazz 1	102	4	3,5	Vince LaDuca
P:176	HipHop Jazz 2	99	8	CY	A • L • M • A
P:177	HipHop Jazz 3	103	8	7	A • L • M • A
P:178	HipHop Soul 1	76	4	6	A • L • M • A
P:179	HipHop Soul 2	90	8	7	A • L • M • A
P:180	HipHop Soul 3	80	4	46	Vince LaDuca
P:181	HipHop Soul 4	80	4	6	Vince LaDuca

House

No.	Name	BPM	Measures	Mute	Programmer
P:182	House 1	123	8	4	SOULMATES MUSICA
P:183	House 2	123	8	5,CY	SOULMATES MUSICA
P:184	House 3	123	8	5,6,7	SOULMATES MUSICA
P:185	House 4	128	4	3	SOULMATES MUSICA
P:186	House 5	122	8	4	SOULMATES MUSICA
P:187	House 6	122	4	7	A • L • M • A
P:188	House 7	123	8	5,7	SOULMATES MUSICA
P:189	Garage House 1	123	8	SD,CL	SOULMATES MUSICA
P:190	Garage House 2	125	8	CY,OT	SOULMATES MUSICA
P:191	Garage House 3	123	8	CY	SOULMATES MUSICA
P:192	Garage House 4	123	8	5,CY	SOULMATES MUSICA
P:193	Garage House 5	123	8	BD	SOULMATES MUSICA
P:194	Garage House 6	120	4	4,CY	SOULMATES MUSICA
P:195	Hard House 1	128	4	5	HEIGO TANI
P:196	Hard House 2	130	4	4,6	HEIGO TANI
P:197	Hard House 3	128	8	4,5	SOULMATES MUSICA
P:198	Hard House 4	128	8	5	SOULMATES MUSICA
P:199	Hard House 5	123	8	6	SOULMATES MUSICA
P:200	Hard House 6	128	8	5,SD	SOULMATES MUSICA
P:201	Hard House 7	130	4	6,TP	HEIGO TANI
P:202	Hard House 8	130	4	4,TP	HEIGO TANI
P:203	Hard House 9	130	4	4	HEIGO TANI
P:204	Hard House 10	130	4	4,6	HEIGO TANI

No.	Name	BPM	Measures	Mute	Programmer
P:205	Happy Handbag 1	130	2	6,7,CY	YOJI BIOMEHANIKA
P:206	Happy Handbag 2	130	4	4,7	YOJI BIOMEHANIKA
P:207	Happy Handbag 3	130	8	CY	SOULMATES MUSICA
P:208	Happy Handbag 4	128	8	5	SOULMATES MUSICA
P:209	Happy Handbag 5	128	8	4	SOULMATES MUSICA
P:210	Euro Beat 1	145	4	5,7,TP	Roland Corporation
P:211	Euro Beat 2	128	8	7	Roland Corporation
P:212	Latin House 1	123	4	3	Roland Corporation
P:213	Latin House 2	122	8	SD	Roland Corporation
P:214	Latin House 3	122	8	7	Roland Corporation
P:215	Latin House 4	122	8	5,CY	SOULMATES MUSICA
P:216	Latin House 5	125	8	4	Roland Corporation

Jazz

No.	Name	BPM	Measures	Mute	Programmer
P:217	Funk 1	126	8	TP	A • L • M • A
P:218	Funk 2	118	8	7	A • L • M • A
P:219	Funk 3	118	8	7	A • L • M • A
P:220	Funk 4	90	8	7	Roland Corporation
P:221	Funk 5	100	4	6	Roland Corporation
P:222	Funk 6	95	8	7	Roland Corporation
P:223	Funk 7	103	8	4	A • L • M • A
P:224	Jazz 1	103	8	6	A • L • M • A
P:225	Jazz 2	123	8	4,5,7	A • L • M • A
P:226	Jazz 3	89	8	7	A • L • M • A
P:227	Jazz 4	130	8	4	Roland Corporation
P:228	Jazz 5	130	8	7	A • L • M • A

Reggae

No.	Name	BPM	Measures	Mute	Programmer
P:229	Dance Hall 1	185	8	HI	A • L • M • A
P:230	Dance Hall 2	158	8	6	A • L • M • A
P:231	Dance Hall 3	180	8	5	Vince LaDuca
P:232	Dance Hall 4	170	8	5	Vince LaDuca
P:233	Dance Hall 5	188	8	4,5	Vince LaDuca
P:234	Lovers 1	181	8	3,7	A • L • M • A
P:235	Lovers 2	176	8	6	A • L • M • A
P:236	Reggae 1	126	8	4,6	A • L • M • A
P:237	Reggae 2	172	16	4	A • L • M • A

Latin

No.	Name	BPM	Measures	Mute	Programmer
P:238	Salsa 1	112	4	5	Scott Tibbs
P:239	Salsa 2	112	4	5	Scott Tibbs
P:240	Salsa 3	104	4	5	Scott Tibbs
P:241	Salsa 4	95	4	4,6	Scott Tibbs
P:242	Salsa 5	88	4	4,6	Scott Tibbs
P:243	Songo	112	4	5,6	Scott Tibbs
P:244	Samba	124	8	2,3,4	A • L • M • A
P:245	ChaCha	84	4	5,6,7	Scott Tibbs
P:246	Merengue	110	2	4,5,6,7	Jeff Fields
P:247	Mambo 1	90	2	4,5,6,7	Jeff Fields
P:248	Mambo 2	90	2	4,5,6,7	Jeff Fields

BD:BD
CYM:CY

SD:SD
TOM/PERC:TP

HH:HH
HIT:HI

CLP:CL
OTHERS:OT

RPS Pattern List

RPS Drum Pattern (Used Rhythm Part)

	Name	BPM	Measures	RPS Set	Keyboard Pad
P:249	Techno Drums 1	135	2	Trance 1	1
P:250	Techno Drums 2	135	2	Trance 1	2
P:251	Techno Drums 3	140	2	Trance 2	1
P:252	Techno Drums 4	140	2	Trance 2	2
P:253	Techno Drums 5	150	1	NU-NRG	1
P:254	Techno Drums 6	150	1	NU-NRG	2
P:255	Techno Drums 7	136	1	Minimal Techno	1
P:256	Techno Drums 8	136	1	Minimal Techno	2
P:257	Techno Drums 9	135	2	Detroit Techno	1
P:258	Techno Drums 10	135	2	Detroit Techno	2
P:259	Techno Drums 11	167	2	Hardcore	1
P:260	Techno Drums 12	167	2	Hardcore	2
P:261	Techno Drums 13	130	2	Rave	1
P:262	Techno Drums 14	130	1	Rave	2
P:263	Techno Drums 15	110	2	Rock	1
P:264	Techno Drums 16	110	2	Rock	2
P:265	Techno Drums 17	130	2	Industrial	1
P:266	Techno Drums 18	130	2	Industrial	2
P:267	Techno Drums 19	125	2	Ambient Techno	1
P:268	Techno Drums 20	125	2	Ambient Techno	2
P:269	D-Bass Drums 1	170	2	Drum'n' Bass 1	1
P:270	D-Bass Drums 2	170	2	Drum'n' Bass 1	2
P:271	D-Bass Drums 3	170	1	Drum'n' Bass 2	1
P:272	D-Bass Drums 4	170	2	Drum'n' Bass 2	2
P:273	D-Bass Drums 5	170	2	Drum'n' Bass 3	1
P:274	D-Bass Drums 6	170	2	Drum'n' Bass 3	2
P:275	D-Bass Drums 7	170	2	Jungle	1
P:276	D-Bass Drums 8	170	2	Jungle	2
P:277	HipHop Drums 1	90	2	HipHop East	1
P:278	HipHop Drums 2	90	2	HipHop East	2
P:279	HipHop Drums 3	95	1	HipHop West	1
P:280	HipHop Drums 4	95	2	HipHop West	2
P:281	HipHop Drums 5	80	2	HipHop Abstract 1	1
P:282	HipHop Drums 6	80	1	HipHop Abstract 1	2
P:283	HipHop Drums 7	70	1	HipHop Abstract 2	1
P:284	HipHop Drums 8	70	2	HipHop Abstract 2	2
P:285	HipHop Drums 9	95	1	HipHop Early	1
P:286	HipHop Drums 10	95	2	HipHop Early	2
P:287	HipHop Drums 11	100	1	HipHop Jazz&Soul	1
P:288	HipHop Drums 12	100	2	HipHop Jazz&Soul	2
P:289	House Drums 1	120	1	House	1
P:290	House Drums 2	120	2	House	2
P:291	House Drums 3	120	2	Garage House	1
P:292	House Drums 4	120	2	Garage House	2
P:293	House Drums 5	130	2	Hard House	1
P:294	House Drums 6	130	2	Hard House	2
P:295	House Drums 7	130	1	Happy Handbag	1
P:296	House Drums 8	130	1	Happy Handbag	2
P:297	Jazz Drums 1	125	2	Jazz Funk 1	1
P:298	Jazz Drums 2	125	2	Jazz Funk 1	2
P:299	Jazz Drums 3	125	2	Jazz Funk 2	1
P:300	Jazz Drums 4	125	1	Jazz Funk 2	2
P:301	Reggae Drums 1	190	4	Reggae 1	1
P:302	Reggae Drums 2	190	4	Reggae 1	2
P:303	Reggae Drums 3	155	2	Reggae 2	1
P:304	Reggae Drums 4	155	2	Reggae 2	2
P:305	Latin Drums 1	110	1	Salsa	1
P:306	Latin Drums 2	110	1	Salsa	2
P:307	Latin Drums 3	125	1	Samba	1
P:308	Latin Drums 4	125	2	Samba	2

RPS Bass Pattern (Used Part1)

	Name	BPM	Measures	RPS Set	Keyboard Pad
P:309	Techno Bass 1	135	1	Trance 1	3
P:310	Techno Bass 2	135	1	Trance 1	4
P:311	Techno Bass 3	140	2	Trance 2	3
P:312	Techno Bass 4	140	1	Trance 2	4
P:313	Techno Bass 5	150	1	NU-NRG	3
P:314	Techno Bass 6	150	1	NU-NRG	4
P:315	Techno Bass 7	136	1	Minimal Techno	3
P:316	Techno Bass 8	136	1	Minimal Techno	4
P:317	Techno Bass 9	135	1	Detroit Techno	3
P:318	Techno Bass 10	135	1	Detroit Techno	4
P:319	Techno Bass 11	167	1	Hardcore	3
P:320	Techno Bass 12	167	2	Hardcore	4
P:321	Techno Bass 13	130	1	Rave	3
P:322	Techno Bass 14	130	2	Rave	4
P:323	Techno Bass 15	110	1	Rock	3
P:324	Techno Bass 16	110	2	Rock	4
P:325	Techno Bass 17	130	2	Industrial	3
P:326	Techno Bass 18	130	2	Industrial	4
P:327	Techno Bass 19	125	2	Ambient Techno	3
P:328	Techno Bass 20	125	1	Ambient Techno	4
P:329	D-Bass Bass 1	170	2	Drum'n' Bass 1	3
P:330	D-Bass Bass 2	170	4	Drum'n' Bass 1	4
P:331	D-Bass Bass 3	170	2	Drum'n' Bass 2	3
P:332	D-Bass Bass 4	170	2	Drum'n' Bass 2	4
P:333	D-Bass Bass 5	170	4	Drum'n' Bass 3	3
P:334	D-Bass Bass 6	170	4	Drum'n' Bass 3	4
P:335	D-Bass Bass 7	170	2	Jungle	3
P:336	D-Bass Bass 8	170	2	Jungle	4
P:337	HipHop Bass 1	90	1	HipHop East	3
P:338	HipHop Bass 2	90	2	HipHop East	4
P:339	HipHop Bass 3	95	2	HipHop West	3
P:340	HipHop Bass 4	95	2	HipHop West	4
P:341	HipHop Bass 5	80	2	HipHop Abstract 1	3
P:342	HipHop Bass 6	80	2	HipHop Abstract 1	4
P:343	HipHop Bass 7	70	1	HipHop Abstract 2	3
P:344	HipHop Bass 8	70	2	HipHop Abstract 2	4
P:345	HipHop Bass 9	95	2	HipHop Early	3
P:346	HipHop Bass 10	95	2	HipHop Early	4
P:347	HipHop Bass 11	100	2	HipHop Jazz&Soul	3
P:348	HipHop Bass 12	100	2	HipHop Jazz&Soul	4
P:349	House Bass 1	120	1	House	3
P:350	House Bass 2	120	1	House	4
P:351	House Bass 3	120	2	Garage House	3
P:352	House Bass 4	120	2	Garage House	4
P:353	House Bass 5	130	1	Hard House	3
P:354	House Bass 6	130	1	Hard House	4
P:355	House Bass 7	130	2	Happy Handbag	3
P:356	House Bass 8	130	2	Happy Handbag	4
P:357	Jazz Bass 1	125	2	Jazz Funk 1	3
P:358	Jazz Bass 2	125	2	Jazz Funk 1	4
P:359	Jazz Bass 3	125	2	Jazz Funk 2	3
P:360	Jazz Bass 4	125	2	Jazz Funk 2	4
P:361	Reggae Bass 1	190	4	Reggae 1	3
P:362	Reggae Bass 2	190	2	Reggae 1	4
P:363	Reggae Bass 3	155	2	Reggae 2	3
P:364	Reggae Bass 4	155	2	Reggae 2	4
P:365	Latin Bass 1	110	2	Salsa	3
P:366	Latin Bass 2	110	1	Salsa	4
P:367	Latin Bass 3	125	2	Samba	3
P:368	Latin Bass 4	125	1	Samba	4

RPS Rhythm Fill in (Used Part1)

	Name	BPM	Measures	RPS Set	Keyboard Pad
P:369	BD Fill 1	150	1	NU-NRG	8
P:370	BD Fill 2	136	1	Minimal Techno	8
P:371	BD Fill 3	167	1	Hardcore	7
P:372	BD Fill 4	130	2	Industrial	6
P:373	BD Fill 5	125	1	Ambient Techno	6
P:374	BD Fill 6	170	1	Drum'n' Bass 2	6
P:375	BD Fill 7	170	1	Drum'n' Bass 3	7
P:376	BD Fill 8	170	2	Jungle	8
P:377	BD Loop 1	120	2	Garage House	8
P:378	BD Loop 2	130	2	Hard House	7
P:379	CHH Fill 1	140	1	Trance 2	7
P:380	CHH Fill 2	100	1	HipHop Jazz&Soul	7
P:381	CHH Fill 3	190	1	Reggae 1	8
P:382	CHH Fill 4	155	1	Reggae 2	8
P:383	LowCHH Loop 1	135	2	Detroit Techno	8
P:384	LowCHH Loop 2	80	1	HipHop Abstract 1	8
P:385	LowCHH Loop 3	130	1	Hard House	6
P:386	RideCym Fill	70	1	HipHop Abstract 2	5
P:387	RideCym Loop 1	136	1	Minimal Techno	7
P:388	RideCym Loop 2	170	1	Jungle	7
P:389	RideCym Loop 3	100	1	HipHop Jazz&Soul	8
P:390	RideCym Loop 4	130	1	Happy Handbag	8
P:391	RideCym Loop 5	125	2	Jazz Funk 1	7
P:392	RideCym Loop 6	125	1	Jazz Funk 2	5
P:393	Clap Fill 1	150	1	NU-NRG	7
P:394	Clap Fill 2	167	1	Hardcore	6
P:395	Clap Fill 3	80	1	HipHop Abstract 1	6
P:396	Clap Fill 4	95	2	HipHop Early	5
P:397	Clap Fill 5	100	1	HipHop Jazz&Soul	6
P:398	Clap Fill 6	120	1	House	6
P:399	Clap Fill 7	120	1	Garage House	7
P:400	Clap Fill 8	130	1	Hard House	8
P:401	Crash Loop 1	135	2	Trance 1	8
P:402	Crash Loop 2	167	1	Hardcore	5
P:403	Snare Fill 1	135	1	Trance 1	5
P:404	Snare Fill 2	135	1	Trance 1	7
P:405	Snare Fill 3	140	1	Trance 2	5
P:406	Snare Fill 4	140	1	Trance 2	8
P:407	Snare Fill 5	150	1	NU-NRG	5
P:408	Snare Fill 6	150	1	NU-NRG	6
P:409	Snare Fill 7	136	1	Minimal Techno	5
P:410	Snare Fill 8	135	1	Detroit Techno	5
P:411	Snare Fill 9	135	1	Detroit Techno	7
P:412	Snare Fill 10	167	1	Hardcore	8
P:413	Snare Fill 11	130	1	Rave	5
P:414	Snare Fill 12	130	1	Rave	7
P:415	Snare Fill 13	130	1	Rave	8
P:416	Snare Fill 14	110	1	Rock	5
P:417	Snare Fill 15	110	1	Rock	7
P:418	Snare Fill 16	110	1	Rock	8
P:419	Snare Fill 17	125	1	Ambient Techno	5
P:420	Snare Fill 18	170	1	Drum'n' Bass 1	5
P:421	Snare Fill 19	170	1	Drum'n' Bass 1	6
P:422	Snare Fill 20	170	1	Drum'n' Bass 1	7
P:423	Snare Fill 21	170	1	Drum'n' Bass 2	5
P:424	Snare Fill 22	170	1	Drum'n' Bass 2	7
P:425	Snare Fill 23	170	1	Drum'n' Bass 2	8
P:426	Snare Fill 24	170	1	Drum'n' Bass 3	5
P:427	Snare Fill 25	170	2	Drum'n' Bass 3	6
P:428	Snare Fill 26	170	1	Drum'n' Bass 3	8
P:429	Snare Fill 27	170	1	Jungle	5
P:430	Snare Fill 28	170	1	Jungle	6

	Name	BPM	Measures	RPS Set	Keyboard Pad
P:431	Snare Fill 29	80	1	HipHop Abstract 1	5
P:432	Snare Fill 30	120	1	House	5
P:433	Snare Fill 31	120	1	House	7
P:434	Snare Fill 32	120	1	House	8
P:435	Snare Fill 33	120	1	Garage House	5
P:436	Snare Fill 34	130	4	Hard House	5
P:437	Snare Fill 35	130	2	Happy Handbag	5
P:438	Snare Fill 36	130	1	Happy Handbag	6
P:439	Snare Fill 37	130	1	Happy Handbag	7
P:440	Snare Fill 38	125	1	Jazz Funk 1	5
P:441	Snare Fill 39	125	1	Jazz Funk 1	6
P:442	Snare Fill 40	125	1	Jazz Funk 1	8
P:443	Snare Fill 41	125	1	Jazz Funk 2	6
P:444	Snare Fill 42	125	1	Jazz Funk 2	7
P:445	Snare Fill 43	125	1	Jazz Funk 2	8
P:446	Snare Fill 44	190	1	Reggae 1	6
P:447	Snare Fill 45	155	1	Reggae 2	6
P:448	Snare Fill 46	155	1	Reggae 2	7
P:449	Snare Fill 47	125	1	Samba	7
P:450	Snare Fill 48	125	1	Samba	8
P:451	Tambourine 1	170	1	Drum'n' Bass 1	8
P:452	Tambourine 2	90	1	HipHop East	5
P:453	Tambourine 3	95	1	HipHop West	6
P:454	Tom Fill 1	130	1	Rave	6
P:455	Tom Fill 2	110	1	Rock	6
P:456	Tom Fill 3	130	1	Industrial	8
P:457	Tom Fill 4	95	1	HipHop West	8
P:458	Tom Fill 5	95	1	HipHop Early	6
P:459	Tom Fill 6	95	1	HipHop Early	7
P:460	Tom Fill 7	190	2	Reggae 1	5
P:461	Tom Fill 8	190	1	Reggae 1	7
P:462	Tom Fill 9	155	1	Reggae 2	5
P:463	Agogo Loop 1	110	1	Salsa	8
P:464	Agogo Loop 2	125	2	Samba	14
P:465	Bell Fill	135	1	Trance 1	6
P:466	Bongo	125	2	Samba	13
P:467	Cowbell Loop 1	136	1	Minimal Techno	6
P:468	Cowbell Loop 2	110	1	Salsa	7
P:469	Gunshot	95	1	HipHop West	7
P:470	Industry Fill 1	130	1	Industrial	5
P:471	Industry Fill 2	130	1	Industrial	7
P:472	Perc Fill 1	140	1	Trance 2	6
P:473	Perc Fill 2	125	1	Ambient Techno	7
P:474	Perc Fill 3	70	1	HipHop Abstract 2	6
P:475	Perc Fill 4	70	1	HipHop Abstract 2	8
P:476	Perc Fill 5	100	1	HipHop Jazz&Soul	5
P:477	Perc Fill 6	120	1	Garage House	6
P:478	Perc Loop 1	135	1	Detroit Techno	6
P:479	Perc Loop 2	125	1	Ambient Techno	8
P:480	Perc Loop 3	70	1	HipHop Abstract 2	7
P:481	Scratch 1	90	1	HipHop East	6
P:482	Scratch 2	90	1	HipHop East	7
P:483	Scratch 3	90	1	HipHop East	8
P:484	Scratch 4	95	1	HipHop West	5
P:485	Scratch 5	80	1	HipHop Abstract 1	7
P:486	Scratch 6	95	1	HipHop Early	8
P:487	Surdo Loop 1	125	2	Samba	5
P:488	Surdo Loop 2	125	1	Samba	6
P:489	Timbales Fill 1	110	1	Salsa	5
P:490	Timbales Fill 2	110	1	Salsa	6
P:491	Whistle Loop	167	1	Hardcore	15

RPS Accompaniment (Used Part1)

	Name	BPM	Measures	RPS Set	Keyboard Pad
P:492	Brass 1	125	2	Jazz Funk 1	14
P:493	Brass 2	125	1	Jazz Funk 2	13
P:494	Brass 3	155	1	Reggae 2	15
P:495	Brass 4	110	2	Salsa	12
P:496	Brass 5	110	2	Salsa	13
P:497	E.Piano Lead 1	80	1	HipHop Abstract 1	11
P:498	E.Piano Lead 2	95	1	HipHop Early	12
P:499	E.Piano Chord 1	170	2	Jungle	9
P:500	E.Piano Chord 2	90	1	HipHop East	10
P:501	E.Piano Chord 3	80	1	HipHop Abstract 1	12
P:502	E.Piano Chord 4	70	2	HipHop Abstract 2	9
P:503	E.Piano Chord 5	100	2	HipHop Jazz&Soul	11
P:504	E.Piano Chord 6	120	2	Garage House	12
P:505	E.Piano Chord 7	120	2	Garage House	13
P:506	E.Piano Chord 8	125	2	Jazz Funk 2	11
P:507	SFX 1	140	2	Trance 2	14
P:508	SFX 2	136	1	Minimal Techno	13
P:509	SFX 3	136	1	Minimal Techno	14
P:510	SFX 4	135	1	Detroit Techno	13
P:511	SFX 5	135	1	Detroit Techno	14
P:512	SFX 6	167	2	Hardcore	14
P:513	SFX 7	130	2	Rave	14
P:514	SFX 8	110	1	Rock	14
P:515	SFX 9	130	1	Industrial	12
P:516	SFX 10	130	2	Industrial	13
P:517	SFX 11	130	2	Industrial	14
P:518	SFX 12	125	4	Ambient Techno	13
P:519	SFX 13	125	1	Ambient Techno	14
P:520	SFX 14	170	2	Drum'n' Bass 1	12
P:521	SFX 15	170	2	Drum'n' Bass 1	13
P:522	SFX 16	170	2	Drum'n' Bass 1	14
P:523	SFX 17	170	1	Drum'n' Bass 2	14
P:524	SFX 18	170	4	Drum'n' Bass 3	13
P:525	SFX 19	170	4	Drum'n' Bass 3	14
P:526	SFX 20	80	1	HipHop Abstract 1	14
P:527	SFX 21	70	2	HipHop Abstract 2	12
P:528	SFX 22	70	2	HipHop Abstract 2	13
P:529	SFX 23	70	2	HipHop Abstract 2	14
P:530	SFX 24	130	2	Hard House	14
P:531	Guitar Chord 1	90	1	HipHop East	12
P:532	Guitar Chord 2	95	2	HipHop West	9
P:533	Guitar Chord 3	95	1	HipHop Early	9
P:534	Guitar Chord 4	190	4	Reggae 1	13
P:535	Guitar Chord 5	155	2	Reggae 2	12
P:536	Guitar Lead	90	2	HipHop East	13
P:537	Guitar Riff 1	150	2	NU-NRG	11
P:538	Guitar Riff 2	130	2	Rave	10
P:539	Guitar Riff 3	110	2	Rock	9
P:540	Guitar Riff 4	110	1	Rock	10
P:541	Guitar Riff 5	100	1	HipHop Jazz&Soul	14
P:542	Guitar Riff 6	125	2	Jazz Funk 1	10
P:543	Guitar Riff 7	125	2	Jazz Funk 1	11
P:544	Guitar Riff 8	125	2	Jazz Funk 1	12
P:545	Guitar Riff 9	155	2	Reggae 2	13
P:546	Guitar Riff 10	155	2	Reggae 2	14
P:547	G Laughter	95	1	HipHop West	14
P:548	Marimba	110	1	Salsa	14
P:549	Organ Chord 1	90	2	HipHop East	9
P:550	Organ Chord 2	90	2	HipHop East	11
P:551	Organ Chord 3	120	2	Garage House	14
P:552	Organ chord 4	130	2	Hard House	9
P:553	Organ Chord 5	125	2	Jazz Funk 1	9

	Name	BPM	Measures	RPS Set	Keyboard Pad
P:554	Organ Chord 6	125	2	Jazz Funk 2	10
P:555	Organ Chord 7	190	4	Reggae 1	11
P:556	Organ Chord 8	190	4	Reggae 1	12
P:557	Organ Chord 9	155	2	Reggae 2	10
P:558	Organ Chord 10	155	2	Reggae 2	11
P:559	Organ Lead 1	170	2	Jungle	14
P:560	Organ Lead 2	95	2	HipHop West	11
P:561	Organ Lead 3	120	1	House	14
P:562	Piano Chord 1	170	2	Drum'n' Bass 2	9
P:563	Piano Chord 2	170	2	Jungle	10
P:564	Piano Chord 3	95	2	HipHop Early	11
P:565	Piano Chord 4	100	2	HipHop Jazz&Soul	12
P:566	Piano Chord 5	120	2	House	10
P:567	Piano Chord 6	120	4	House	11
P:568	Piano Chord 7	120	2	Garage House	11
P:569	Piano Chord 8	130	2	Hard House	10
P:570	Piano Chord 9	130	2	Happy Handbag	9
P:571	Piano Chord 10	125	2	Jazz Funk 2	9
P:572	Piano Chord 11	190	2	Reggae 1	9
P:573	Piano Chord 12	190	4	Reggae 1	10
P:574	Piano Chord 13	155	2	Reggae 2	9
P:575	Piano Chord 14	110	4	Salsa	9
P:576	Piano Chord 15	110	2	Salsa	10
P:577	Piano Chord 16	110	2	Salsa	11
P:578	Phono Noise	90	1	HipHop East	16
P:579	Piano Seq	167	1	Hardcore	9
P:580	Synth Lead 1	170	4	Drum'n' Bass 1	11
P:581	Synth Lead 2	170	4	Jungle	13
P:582	Synth Lead 3	95	2	HipHop West	12
P:583	Synth Lead 4	70	2	HipHop Abstract 2	11
P:584	Synth Lead 5	95	2	HipHop Early	13
P:585	Synth Lead 6	95	1	HipHop Early	14
P:586	Synth Lead 7	100	2	HipHop Jazz&Soul	13
P:587	Synth Lead 8	125	2	Samba	11
P:588	Str.Obligato 1	95	4	HipHop West	10
P:589	Str.Obligato 2	80	2	HipHop Abstract 1	10
P:590	Str.Obligato 3	130	4	Hard House	13
P:591	Synth Pad 1	135	4	Trance 1	9
P:592	Synth Pad 2	140	4	Trance 2	9
P:593	Synth Pad 3	150	4	NU-NRG	9
P:594	Synth Pad 4	135	4	Detroit Techno	9
P:595	Synth Pad 5	130	2	Rave	9
P:596	Synth Pad 6	125	4	Ambient Techno	9
P:597	Synth Pad 7	170	4	Drum'n' Bass 1	9
P:598	Synth Pad 8	170	2	Drum'n' Bass 1	10
P:599	Synth Pad 9	170	2	Drum'n' Bass 3	9
P:600	Synth Pad 10	70	2	HipHop Abstract 2	10
P:601	Synth Pad 11	100	2	HipHop Jazz&Soul	9
P:602	Synth Pad 12	100	4	HipHop Jazz&Soul	10
P:603	Synth Pad 13	120	2	Garage House	9
P:604	Synth Pad 14	120	2	Garage House	10
P:605	Synth Pad 15	125	4	Jazz Funk 2	12
P:606	Synth Pad 16	125	2	Samba	9
P:607	Synth Pad 17	125	2	Samba	10
P:608	Synth Riff 1	135	2	Trance 1	10
P:609	Synth Riff 2	135	2	Trance 1	12
P:610	Synth Riff 3	135	2	Trance 1	14
P:611	Synth Riff 4	140	2	Trance 2	10
P:612	Synth Riff 5	140	2	Trance 2	11
P:613	Synth Riff 6	140	2	Trance 2	12
P:614	Synth Riff 7	150	2	NU-NRG	10
P:615	Synth Riff 8	150	2	NU-NRG	12

	Name	BPM	Measures	RPS Set	Keyboard Pad
P:616	Synth Riff 9	150	2	NU-NRG	13
P:617	Synth Riff 10	136	1	Minimal Techno	9
P:618	Synth Riff 11	167	2	Hardcore	10
P:619	Synth Riff 12	167	2	Hardcore	11
P:620	Synth Riff 13	167	2	Hardcore	12
P:621	Synth Riff 14	167	2	Hardcore	13
P:622	Synth Riff 15	130	2	Rave	11
P:623	Synth Riff 16	130	1	Rave	12
P:624	Synth Riff 17	130	1	Rave	13
P:625	Synth Riff 18	110	1	Rock	13
P:626	Synth Riff 19	125	2	Ambient Techno	10
P:627	Synth Riff 20	170	2	Drum'n' Bass 2	11
P:628	Synth Riff 21	170	2	Drum'n' Bass 2	12
P:629	Synth Riff 22	170	2	Drum'n' Bass 3	10
P:630	Synth Riff 23	95	1	HipHop West	13
P:631	Synth Riff 24	80	2	HipHop Abstract 1	9
P:632	Synth Riff 25	95	1	HipHop Early	10
P:633	Synth Riff 26	120	1	House	9
P:634	Synth Riff 27	130	2	Hard House	11
P:635	Synth Riff 28	136	2	Hard House	12
P:636	Synth Riff 29	130	2	Happy Handbag	10
P:637	Synth Riff 30	130	2	Happy Handbag	11
P:638	Synth Riff 31	130	2	Happy Handbag	12
P:639	Synth Riff 32	130	2	Happy Handbag	13
P:640	Synth Riff 33	130	2	Happy Handbag	14
P:641	Synth Seq 1	135	1	Trance 1	13
P:642	Synth Seq 2	140	2	Trance 2	13
P:643	Synth Seq 3	136	1	Minimal Techno	10
P:644	Synth Seq 4	150	2	NU-NRG	14
P:645	Synth Seq 5	136	1	Minimal Techno	11
P:646	Synth Seq 6	136	1	Minimal Techno	12
P:647	Synth Seq 7	135	2	Detroit Techno	10
P:648	Synth Seq 8	135	1	Detroit Techno	11
P:649	Synth Seq 9	135	1	Detroit Techno	12
P:650	Synth Seq 10	110	1	Rock	11
P:651	Synth Seq 11	130	2	Industrial	9
P:652	Synth Seq 12	130	2	Industrial	10
P:653	Synth Seq 13	130	1	Industrial	11
P:654	Synth Seq 14	125	1	Ambient Techno	11
P:655	Synth Seq 15	125	1	Ambient Techno	12
P:656	Synth Seq 16	170	1	Drum'n' Bass 2	13
P:657	Synth Seq 17	170	1	Jungle	11
P:658	Synth Seq 18	170	4	Jungle	12
P:659	Synth Seq 19	120	2	House	13
P:660	Synth Seq 20	125	1	Jazz Funk 1	13
P:661	Synth Seq 21	125	2	Samba	12
P:662	Vibe Lead	90	2	HipHop East	14
P:663	Vox 1	135	2	Trance 1	11
P:664	Vox 2	110	2	Rock	12
P:665	Vox 3	170	2	Drum'n' Bass 2	10
P:666	Vox 4	170	2	Drum'n' Bass 3	11
P:667	Vox 5	170	4	Drum'n' Bass 3	12
P:668	Vox 6	80	2	HipHop Abstract 1	13
P:669	Vox 7	120	2	House	12
P:670	Voice Riff	125	1	Jazz Funk 2	14

RPS Hit (Used Part1)

	Name	BPM	Measures	RPS Set	Keyboard Pad
P:671	Bird	125	1	Ambient Techno	16
P:672	Brass Fall 1	170	1	Jungle	15
P:673	Brass Fall 2	110	1	Salsa	15
P:674	Brass Hit	95	2	Reggae 1	14
P:675	Blip Hit 1	135	1	Trance 1	16
P:676	Blip Hit 2	190	1	Reggae 1	15
P:677	Crash Cymbal	150	1	NU-NRG	16
P:678	SFX Hit 1	140	1	Trance 2	16
P:679	SFX Hit 2	136	1	Minimal Techno	15
P:680	SFX Hit 3	136	1	Minimal Techno	16
P:681	SFX Hit 4	135	1	Detroit Techno	15
P:682	SFX Hit 5	135	1	Detroit Techno	16
P:683	SFX Hit 7	170	1	Drum'n' Bass 1	15
P:684	SFX Hit 8	70	1	HipHop Abstract 2	16
P:685	SFX Hit 9	130	1	Hard House	15
P:686	SFX Hit 10	155	1	Reggae 2	16
P:687	HipHop Hit 1	90	2	HipHop East	15
P:688	HipHop Hit 2	95	1	HipHop West	15
P:689	HipHop Hit 3	95	1	HipHop Early	15
P:690	Happy Hit	150	2	NU-NRG	15
P:691	Industry Hit 1	135	1	Trance 1	15
P:692	Industry Hit 2	110	1	Rock	15
P:693	Industry Hit 3	130	1	Industrial	16
P:694	Industry Hit 4	170	1	Drum'n' Bass 1	16
P:695	Industry Hit 5	170	1	Drum'n' Bass 2	16
P:696	Industry Hit 6	170	1	Drum'n' Bass 3	15
P:697	Industry Hit 7	170	1	Drum'n' Bass 3	16
P:698	Industry Hit 8	130	1	Hard House	16
P:699	Orchestra Hit 1	167	1	Hardcore	16
P:700	Orchestra Hit 2	130	1	Rave	15
P:701	Orchestra Hit 3	170	2	Drum'n' Bass 2	15
P:702	Orchestra Hit 4	120	1	Garage House	16
P:703	Orchestra Hit 5	95	1	Happy Handbag	15
P:704	Piano Delay	125	2	Ambient Techno	15
P:705	Voice Hit 1	130	1	Rave	16
P:706	Voice Hit 2	110	1	Rock	16
P:707	Voice Hit 3	95	1	HipHop West	16
P:708	Voice Hit 4	95	1	HipHop Early	16
P:709	Voice Hit 5	100	1	HipHop Jazz&Soul	15
P:710	Voice Hit 6	120	1	House	15
P:711	Voice Hit 7	130	1	Happy Handbag	16
P:712	Voice Hit 8	125	1	Jazz Funk 1	15
P:713	Whistle Hit 1	170	1	Jungle	16
P:714	Whistle Hit 2	125	1	Samba	15

RPS Set List

* U:31–U:60 have the same contents as U:01–U:30.

* The number at the right of each RPS set is the recommended tempo when using that set.

U:01 Trance1 (BPM=135)

1	Techno Drums 1	P:249
2	Techno Drums 2	P:250
3	Techno Bass 1	P:309
4	Techno Bass 2	P:310
5	Snare Fill 1	P:403
6	Bell Fill	P:465
7	Snare Fill 2	P:404
8	Crash Loop 1	P:401
9	Synth Pad 1	P:591
10	Synth Riff 1	P:608
11	Vox 1	P:663
12	Synth Riff 2	P:609
13	Synth Seq 1	P:641
14	Synth Riff 3	P:610
15	Industry Hit 1	P:691
16	Blip Hit 1	P:675

U:04 Minimal Techno (BPM=136)

1	Techno Drums 7	P:255
2	Techno Drums 8	P:256
3	Techno Bass 7	P:315
4	Techno Bass 8	P:316
5	Snare Fill 7	P:409
6	Cowbell Loop 1	P:467
7	RideCym Loop 1	P:387
8	BD Fill 2	P:370
9	Synth Riff 10	P:617
10	Synth Seq 3	P:643
11	Synth Seq 5	P:645
12	Synth Seq 6	P:646
13	SFX 2	P:508
14	SFX 3	P:509
15	SFX Hit 2	P:679
16	SFX Hit 3	P:680

U:07 Rave (BPM=130)

1	Techno Drums 13	P:261
2	Techno Drums 14	P:262
3	Techno Bass 13	P:321
4	Techno Bass 14	P:322
5	Snare Fill 11	P:413
6	Tom Fill 1	P:454
7	Snare Fill 12	P:414
8	Snare Fill 13	P:415
9	Synth Pad 5	P:595
10	Guitar Riff 2	P:538
11	Synth Riff 15	P:622
12	Synth Riff 16	P:623
13	Synth Riff 17	P:624
14	SFX 7	P:513
15	Orchestra Hit 2	P:700
16	Voice Hit 1	P:705

U:02 Trance2 (BPM=140)

1	Techno Drums 3	P:251
2	Techno Drums 4	P:252
3	Techno Bass 3	P:311
4	Techno Bass 4	P:312
5	Snare Fill 3	P:405
6	Perc Fill 1	P:472
7	CHH Fill 1	P:379
8	Snare Fill 4	P:406
9	Synth Pad 2	P:592
10	Synth Riff 4	P:611
11	Synth Riff 5	P:612
12	Synth Riff 6	P:613
13	Synth Seq 2	P:642
14	SFX 1	P:507
15	Industry Hit 1	P:691
16	SFX Hit 1	P:678

U:05 Detroit Techno (BPM=135)

1	Techno Drums 9	P:257
2	Techno Drums 10	P:258
3	Techno Bass 9	P:317
4	Techno Bass 10	P:318
5	Snare Fill 8	P:410
6	Perc Loop 1	P:478
7	Snare Fill 9	P:411
8	LowCHH Loop 1	P:383
9	Synth Pad 4	P:594
10	Synth Seq 7	P:647
11	Synth Seq 8	P:648
12	Synth Seq 9	P:649
13	SFX 4	P:510
14	SFX 5	P:511
15	SFX Hit 4	P:681
16	SFX Hit 5	P:682

U:08 Rock (BPM=110)

1	Techno Drums 15	P:263
2	Techno Drums 16	P:264
3	Techno Bass 15	P:323
4	Techno Bass 16	P:324
5	Snare Fill 14	P:416
6	Tom Fill 2	P:455
7	Snare Fill 15	P:417
8	Snare Fill 16	P:418
9	Guitar Riff 3	P:539
10	Guitar Riff 4	P:540
11	Synth Seq 10	P:650
12	Vox 2	P:664
13	Synth Riff 18	P:625
14	SFX 8	P:514
15	Industry Hit 2	P:692
16	Voice Hit 2	P:706

U:03 NU-NRG (BPM=150)

1	Techno Drums 5	P:253
2	Techno Drums 6	P:254
3	Techno Bass 5	P:313
4	Techno Bass 6	P:314
5	Snare Fill 5	P:407
6	Snare Fill 6	P:408
7	Clap Fill 1	P:393
8	BD Fill 1	P:369
9	Synth Pad 3	P:593
10	Synth Riff 7	P:614
11	Guitar Riff 1	P:537
12	Synth Riff 8	P:615
13	Synth Riff 9	P:616
14	Synth Seq 4	P:644
15	Happy Hit	P:690
16	Crash Cymbal	P:677

U:06 Hardcore (BPM=167)

1	Techno Drums 11	P:259
2	Techno Drums 12	P:260
3	Techno Bass 11	P:319
4	Techno Bass 12	P:320
5	Crash Loop 2	P:402
6	Clap Fill 2	P:394
7	BD Fill 3	P:371
8	Snare Fill 10	P:412
9	Piano Seq	P:579
10	Synth Riff 11	P:618
11	Synth Riff 12	P:619
12	Synth Riff 13	P:620
13	Synth Riff 14	P:621
14	SFX 6	P:512
15	Whistle Loop	P:491
16	Orchestra Hit 1	P:699

U:09 Industrial (BPM=130)

1	Techno Drums 17	P:265
2	Techno Drums 18	P:266
3	Techno Bass 17	P:325
4	Techno Bass 18	P:326
5	Industry Fill 1	P:470
6	BD Fill 4	P:372
7	Industry Fill 2	P:471
8	Tom Fill 3	P:456
9	Synth Seq 11	P:651
10	Synth Seq 12	P:652
11	Synth Seq 13	P:653
12	SFX 9	P:515
13	SFX 10	P:516
14	SFX 11	P:517
15	Industry Hit 1	P:691
16	Industry Hit 3	P:693

U:10 Ambient Techno (BPM=125)

1	Techno Drums 19	P:267
2	Techno Drums 20	P:268
3	Techno Bass 19	P:327
4	Techno Bass 20	P:328
5	Snare Fill 17	P:419
6	BD Fill 5	P:373
7	Perc Fill 2	P:473
8	Perc Loop 2	P:479
9	Synth Pad 6	P:596
10	Synth Riff 19	P:626
11	Synth Seq 14	P:654
12	Synth Seq 15	P:655
13	SFX 12	P:518
14	SFX 13	P:519
15	Piano Delay	P:704
16	Bird	P:671

U:13 Drum'n' Bass 3 (BPM=170)

1	D-Bass Drums 5	P:273
2	D-Bass Drums 6	P:274
3	D-Bass Bass 5	P:333
4	D-Bass Bass 6	P:334
5	Snare Fill 24	P:426
6	Snare Fill 25	P:427
7	BD Fill 7	P:375
8	Snare Fill 26	P:428
9	Synth Pad 9	P:599
10	Synth Riff 22	P:629
11	Vox 4	P:666
12	Vox 5	P:667
13	SFX 18	P:524
14	SFX 19	P:525
15	Industry Hit 6	P:696
16	Industry Hit 7	P:697

U:16 HipHop West (BPM=95)

1	HipHop Drums 3	P:279
2	HipHop Drums 4	P:280
3	HipHop Bass 3	P:339
4	HipHop Bass 4	P:340
5	Scratch 4	P:484
6	Tambourine 3	P:453
7	Gunshot	P:469
8	Tom Fill 4	P:457
9	Guitar Chord 2	P:532
10	Str.Obligato 1	P:588
11	Organ Lead 2	P:560
12	Synth Lead 3	P:582
13	Synth Riff 23	P:630
14	G Laughter	P:547
15	HipHop Hit 2	P:688
16	Voice Hit 3	P:707

U:11 Drum'n' Bass 1 (BPM=170)

1	D-Bass Drums 1	P:269
2	D-Bass Drums 2	P:270
3	D-Bass Bass 1	P:329
4	D-Bass Bass 2	P:330
5	Snare Fill 18	P:420
6	Snare Fill 19	P:421
7	Snare Fill 20	P:422
8	Tambourine 1	P:451
9	Synth Pad 7	P:597
10	Synth Pad 8	P:598
11	Synth Lead 1	P:580
12	SFX 14	P:520
13	SFX 15	P:521
14	SFX 16	P:522
15	SFX Hit 7	P:683
16	Industry Hit 4	P:694

U:14 Jungle (BPM=170)

1	D-Bass Drums 7	P:275
2	D-Bass Drums 8	P:276
3	D-Bass Bass 7	P:335
4	D-Bass Bass 8	P:336
5	Snare Fill 27	P:429
6	Snare Fill 28	P:430
7	RideCym Loop 2	P:388
8	BD Fill 8	P:376
9	E.Piano Chord 1	P:499
10	Piano Chord 2	P:563
11	Synth Seq 17	P:657
12	Synth Seq 18	P:658
13	Synth Lead 2	P:581
14	Organ Lead 1	P:559
15	Brass Fall 1	P:672
16	Whistle Hit 1	P:713

U:17 HipHop Abstract1 (BPM=80)

1	HipHop Drums 5	P:281
2	HipHop Drums 6	P:282
3	HipHop Bass 5	P:341
4	HipHop Bass 6	P:342
5	Snare Fill 29	P:431
6	Clap Fill 3	P:395
7	Scratch 5	P:485
8	LowCHH Loop 2	P:384
9	Synth Riff 24	P:631
10	Str.Obligato 2	P:589
11	E.Piano Lead 1	P:497
12	E.Piano Chord 3	P:501
13	Vox 6	P:668
14	SFX 20	P:526
15	Phono Noise	P:578
16	Piano Delay	P:704

U:12 Drum'n' Bass 2 (BPM=170)

1	D-Bass Drums 3	P:271
2	D-Bass Drums 4	P:272
3	D-Bass Bass 3	P:331
4	D-Bass Bass 4	P:332
5	Snare Fill 21	P:423
6	BD Fill 6	P:374
7	Snare Fill 22	P:424
8	Snare Fill 23	P:425
9	Piano Chord 1	P:562
10	Vox 3	P:665
11	Synth Riff 20	P:627
12	Synth Riff 21	P:628
13	Synth Seq 16	P:656
14	SFX 17	P:523
15	Orchestra Hit 3	P:701
16	Industry Hit 5	P:695

U:15 HipHop East (BPM=90)

1	HipHop Drums 1	P:277
2	HipHop Drums 2	P:278
3	HipHop Bass 1	P:337
4	HipHop Bass 2	P:338
5	Tambourine 2	P:452
6	Scratch 1	P:481
7	Scratch 2	P:482
8	Scratch 3	P:483
9	Organ Chord 1	P:549
10	E.Piano Chord 2	P:500
11	Organ Chord 2	P:550
12	Guitar Chord 1	P:531
13	Guitar Lead	P:536
14	Vibe Lead	P:662
15	HipHop Hit 1	P:687
16	Phono Noise	P:578

U:18 HipHop Abstract2 (BPM=70)

1	HipHop Drums 7	P:283
2	HipHop Drums 8	P:284
3	HipHop Bass 7	P:343
4	HipHop Bass 8	P:344
5	RideCym Fill	P:386
6	Perc Fill 3	P:474
7	Perc Loop 3	P:480
8	Perc Fill 4	P:475
9	E.Piano Chord 4	P:502
10	Synth Pad 10	P:600
11	Synth Lead 4	P:583
12	SFX 21	P:527
13	SFX 22	P:528
14	SFX 23	P:529
15	Piano Delay	P:704
16	SFX Hit 8	P:684

U:19 HipHop Early (BPM=95)

1	HipHop Drums 9	P:285
2	HipHop Drums 10	P:286
3	HipHop Bass 9	P:345
4	HipHop Bass 10	P:346
5	Clap Fill 4	P:396
6	Tom Fill 5	P:458
7	Tom Fill 6	P:459
8	Scratch 6	P:486
9	Guitar Chord 3	P:533
10	Synth Riff 25	P:632
11	Piano Chord 3	P:564
12	E.Piano Lead 2	P:498
13	Synth Lead 5	P:584
14	Synth Lead 6	P:585
15	HipHop Hit 3	P:689
16	Voice Hit 4	P:708

U:20 HipHop Jazz&Soul (BPM=100)

1	HipHop Drums 11	P:287
2	HipHop Drums 12	P:288
3	HipHop Bass 11	P:347
4	HipHop Bass 12	P:348
5	Perc Fill 5	P:476
6	Clap Fill 5	P:397
7	CHH Fill 2	P:380
8	RideCym Loop 3	P:389
9	Synth Pad 11	P:601
10	Synth Pad 12	P:602
11	E.Piano Chord 5	P:503
12	Piano Chord 4	P:565
13	Synth Lead 7	P:586
14	Guitar Riff 5	P:541
15	Voice Hit 5	P:709
15	Brass Fall 1	P:672

U:21 House (BPM=120)

1	House Drums 1	P:289
2	House Drums 2	P:290
3	House Bass 1	P:349
4	House Bass 2	P:350
5	Snare Fill 30	P:432
6	Clap Fill 6	P:398
7	Snare Fill 31	P:433
8	Snare Fill 32	P:434
9	Synth Riff 26	P:633
10	Piano Chord 5	P:566
11	Piano Chord 6	P:567
12	Vox 7	P:669
13	Synth Seq 19	P:659
14	Organ Lead 3	P:561
15	Voice Hit 6	P:710
16	Crash Cymbal	P:677

U:22 Garage House (BPM=120)

1	House Drums 3	P:291
2	House Drums 4	P:292
3	House Bass 3	P:351
4	House Bass 4	P:352
5	Snare Fill 33	P:435
6	Perc Fill 6	P:477
7	Clap Fill 7	P:399
8	BD Loop 1	P:377
9	Synth Pad 13	P:603
10	Synth Pad 14	P:604
11	Piano Chord 7	P:568
12	E.Piano Chord 6	P:504
13	E.Piano Chord 7	P:505
14	Organ Chord 3	P:551
15	Crash Cymbal	P:677
16	Orchestra Hit 4	P:702

U:23 Hard House (BPM=130)

1	House Drums 5	P:293
2	House Drums 6	P:294
3	House Bass 5	P:353
4	House Bass 6	P:354
5	Snare Fill 34	P:436
6	LowCHH Loop 3	P:385
7	BD Loop 2	P:378
8	Clap Fill 8	P:400
9	Organ chord 4	P:552
10	Piano Chord 8	P:569
11	Synth Riff 27	P:634
12	Synth Riff 28	P:635
13	Str.Obligato 3	P:590
14	SFX 24	P:530
15	SFX Hit 9	P:685
16	Industry Hit 8	P:698

U:24 Happy Handbag (BPM=130)

1	House Drums 7	P:295
2	House Drums 8	P:296
3	House Bass 7	P:355
4	House Bass 8	P:356
5	Snare Fill 35	P:437
6	Snare Fill 36	P:438
7	Snare Fill 37	P:439
8	RideCym Loop 4	P:390
9	Piano Chord 9	P:570
10	Synth Riff 29	P:636
11	Synth Riff 30	P:637
12	Synth Riff 31	P:638
13	Synth Riff 32	P:639
14	Synth Riff 33	P:640
15	Orchestra Hit 5	P:703
16	Voice Hit 7	P:711

U:25 Jazz Funk 1 (BPM=125)

1	Jazz Drums 1	P:297
2	Jazz Drums 2	P:298
3	Jazz Bass 1	P:357
4	Jazz Bass 2	P:358
5	Snare Fill 38	P:440
6	Snare Fill 39	P:441
7	RideCym Loop 5	P:391
8	Snare Fill 40	P:442
9	Organ Chord 5	P:553
10	Guitar Riff 6	P:542
11	Guitar Riff 7	P:543
12	Guitar Riff 8	P:544
13	Synth Seq 20	P:660
14	Brass 1	P:492
15	Voice Hit 8	P:712
16	Brass Fall 1	P:672

U:26 Jazz Funk 2 (BPM=125)

1	Jazz Drums 3	P:299
2	Jazz Drums 4	P:300
3	Jazz Bass 3	P:359
4	Jazz Bass 4	P:360
5	RideCym Loop 6	P:392
6	Snare Fill 41	P:443
7	Snare Fill 42	P:444
8	Snare Fill 43	P:445
9	Piano Chord 10	P:571
10	Organ Chord 6	P:554
11	E.Piano Chord 8	P:506
12	Synth Pad 15	P:605
13	Brass 2	P:493
14	Voice Riff	P:670
15	Brass Fall 1	P:672
16	Voice Hit 5	P:709

U:27 Reggae 1 (BPM=190)

1	Reggae Drums 1	P:301
2	Reggae Drums 2	P:302
3	Reggae Bass 1	P:361
4	Reggae Bass 2	P:362
5	Tom Fill 7	P:460
6	Snare Fill 44	P:446
7	Tom Fill 8	P:461
8	CHH Fill 3	P:381
9	Piano Chord 11	P:572
10	Piano Chord 12	P:573
11	Organ Chord 7	P:555
12	Organ Chord 8	P:556
13	Guitar Chord 4	P:534
14	Brass Hit	P:674
15	Blip Hit 2	P:676
16	Orchestra Hit 5	P:703

U:28 Reggae 2 (BPM=155)

1	Reggae Drums 3	P:303
2	Reggae Drums 4	P:304
3	Reggae Bass 3	P:363
4	Reggae Bass 4	P:364
5	Tom Fill 9	P:462
6	Snare Fill 45	P:447
7	Snare Fill 46	P:448
8	CHH Fill 4	P:382
9	Piano Chord 13	P:574
10	Organ Chord 9	P:557
11	Organ Chord 10	P:558
12	Guitar Chord 5	P:535
13	Guitar Riff 9	P:545
14	Guitar Riff 10	P:546
15	Brass 3	P:494
16	SFX Hit 10	P:686

U:29 Salsa (BPM=110)

1	Latin Drums 1	P:305
2	Latin Drums 2	P:306
3	Latin Bass 1	P:365
4	Latin Bass 2	P:366
5	Timbales Fill 1	P:489
6	Timbales Fill 2	P:490
7	Cowbell Loop 2	P:468
8	Agogo Loop 1	P:463
9	Piano Chord 14	P:575
10	Piano Chord 15	P:576
11	Piano Chord 16	P:577
12	Brass 4	P:495
13	Brass 5	P:496
14	Marimba	P:548
15	Brass Fall 2	P:673
16	Crash Cymbal	P:677

U:30 Samba (BPM=125)

1	Latin Drums 3	P:307
2	Latin Drums 4	P:308
3	Latin Bass 3	P:367
4	Latin Bass 4	P:368
5	Surdo Loop 1	P:487
6	Surdo Loop 2	P:488
7	Snare Fill 47	P:449
8	Snare Fill 48	P:450
9	Synth Pad 16	P:606
10	Synth Pad 17	P:607
11	Synth Lead 8	P:587
12	Synth Seq 21	P:661
13	Bongo	P:466
14	Agogo Loop 2	P:464
15	Whistle Hit 2	P:714
15	Brass Fall 1	P:672

Parameter List

Patch Parameters

#: Parameters which can also be operated from the front-panel knobs or buttons.

WAVE/FXM section	[EDIT] + KEY PAD [1] (p. 35)	
WAVE: Tone SW #	Tone Switch	OFF, ON
WAVE: Wave Select #	Wave Select	A001–B251
WAVE: Wave Gain	Wave Gain	-6, 0, +6, +12
FXM: FXM SW	FXM Switch	OFF, ON
FXM: FXM Color	FXMColor	1–4
FXM: FXM Depth	FXMDepth	1–16

PITCH section	[EDIT] + KEY PAD [2] (p. 36)	
PITCH: CoarseTune #	Coarse Tune	-48–+48
PITCH: Fine Tune #	Fine Tune	-50–+50
PITCH: Rnd Pitch	Random Pitch Depth	1*
PITCH: Key Follow	Pitch Key Follow	2*

1*: 0, 1, 2, 3, 4, 5, 6, 7, 8, 9, 10, 20, 30, 40, 50, 60, 70, 80, 90, 100, 200, 300, 400, 500, 600, 700, 800, 900, 1000, 1100, 1200

2*: -100, -70, -50, -30, -10, 0, +10, +20, +30, +40, +50, +70, +100, +120, +150, +200

P-ENV section	[EDIT] + KEY PAD [3] (p. 38)	
P-ENV: ENV Depth #	Envelope Depth	-12–+12
P-ENV: Velo Sens	Velocity Sens	-100–+150
P-ENV: Velo Time1	Velocity Time1 Sens	1*
P-ENV: Velo Time4	Velocity Time4 Sens	1*
P-ENV: Time KF	Time Key Follow	1*
P-ENV: [A]Time1 #	Time1 (Attack Time)	0–127
P-ENV: Time2	Time2	0–127
P-ENV: [D]Time3 #	Time3 (Decay Time)	0–127
P-ENV: [R]Time4 #	Time4 (Release Time)	0–127
P-ENV: Level1	Level1	-63–+63
P-ENV: Level2	Level2	-63–+63
P-ENV: [S]Level3 #	Level3 (Sustain Level)	-63–+63
P-ENV: Level4	Level4	-63–+63

1*: -100, -70, -50, -40, -30, -20, -10, 0, +10, +20, +30, +40, +50, +70, +100

FILTER section	[EDIT] + KEY PAD [4] (p. 42)	
FILTER: Type #	Filter Type	OFF, LPF, BPF, HPF, PKG
FILTER: Cutoff #	Cutoff Frequency	0–127
FILTER: Cutoff KF	Cutoff Key Follow	1*
FILTER: Resonance #	Resonance	0–127
FILTER: Reso Velo	Resonance Velocity Sens	-100–+150

1*: -100, -70, -50, -30, -10, 0, +10, +20, +30, +40, +50, +70, +100, +120, +150, +200

F-ENV section	[EDIT] + KEY PAD [5] (p. 44)	
F-ENV: ENV Depth #	Envelope Depth	-63–+63
F-ENV: Velo Curve	Velocity Curve	1–7
F-ENV: Velo Sens	Velocity Sens	-100–+150
F-ENV: Velo Time1	Velocity Time1 Sens	1*
F-ENV: Velo Time4	Velocity Time4 Sens	1*
F-ENV: Time KF	Time Key Follow	1*
F-ENV: [A]Time1 #	Time1 (Attack Time)	0–127
F-ENV: Time2	Time2	0–127
F-ENV: [D]Time3 #	Time3 (Decay Time)	0–127
F-ENV: [R]Time4 #	Time4 (Release Time)	0–127
F-ENV: Level1	Level1	0–127
F-ENV: Level2	Level2	0–127
F-ENV: [S]Level3 #	Level3 (Sustain Level)	0–127
F-ENV: Level4	Level4	0–127

1*: -100, -70, -50, -40, -30, -20, -10, 0, +10, +20, +30, +40, +50, +70, +100

AMPLIFIER/LEVEL section	[EDIT] + KEY PAD [6] (p. 46)	
LEVEL: Tone Level #	Tone Level	0–127
LEVEL: Bias Dir	Bias Direction	LWR, UPR, L&U, ALL
LEVEL: Bias Point	Bias Point	C-1–G9
LEVEL: Bias Level	Bias Point Level	1*

1*: -100, -70, -50, -40, -30, -20, -10, 0, +10, +20, +30, +40, +50, +70, +100

AMPLIFIER/PAN section	[EDIT] + KEY PAD [7] (p. 47)	
PAN: Tone Pan #	Tone Pan	L64–63R
PAN: Pan KF	Pan Key Follow	1*
PAN: Rnd Pan Sw #	Random Pan Switch	OFF, ON
PAN: Alt Pan Dpth	Alternate Pan Depth	L63–63R

1*: -100, -70, -50, -40, -30, -20, -10, 0, +10, +20, +30, +40, +50, +70, +100

A-ENV section	[EDIT] + KEY PAD [8] (p. 49)	
A-ENV: Velo Curve	Velocity Curve	1–7
A-ENV: Velo Sens	Velocity Sens	-100–+150
A-ENV: Velo Time1	Velocity Time1 Sens	1*
A ENV: Velo Time4	Velocity Time4 Sens	1*
A-ENV: Time KF	Time Key Follow	1*
A-ENV: [A]Time1 #	Time1 (Attack Time)	0–127
A-ENV: Time2	Time2	0–127
A-ENV: [D]Time3 #	Time3 (Decay Time)	0–127
A-ENV: [R]Time4 #	Time4 (Release Time)	0–127
A-ENV: Level1	Level1	0–127
A-ENV: Level2	Level2	0–127
A-ENV: [S]Level3 #	Level3 (Sustain Level)	0–127

1*: -100, -70, -50, -40, -30, -20, -10, 0, +10, +20, +30, +40, +50, +70, +100

LFO1 section	[EDIT] + KEY PAD [9] (p. 52)	
LFO1: Waveform #	Waveform	TRI, SIN, SAW, SQR, TRP, S&H, RND, CHS
LFO1: Rate #	Rate	0–127, 1*
LFO1: Tempo Sync	Tempo Sync	OFF, ON
LFO1: Key Sync	Key Sync	OFF, ON
LFO1: Fade Mode	Fade Mode	OnI, OnO, OfI, OfO
LFO1: Delay Time	Delay Time	0–127
LFO1: Fade Time	Fade Time	0–127
LFO1: Offset	Level Offset	-100, -50, 0, +50, +100
LFO1: Pitch Depth #	Pitch Depth	-63–+63
LFO1: FilterDepth #	Filter Depth	-63–+63
LFO1: Amp Depth #	Amplifier Depth	-63–+63
LFO1: Pan Depth	Pan Depth	-63–+63

1*: Note

LFO2 section	[EDIT] + KEY PAD [10] (p. 52)	
LFO2: Waveform	Waveform	TRI, SIN, SAW, SQR, TRP, S&H, RND, CHS
LFO2: Rate	Rate	0–127, 1*
LFO2: Tempo Sync	Tempo Sync	OFF, ON
LFO2: Key Sync	Key Sync	OFF, ON
LFO2: Fade Mode	Fade Mode	OnI, OnO, OfI, OfO
LFO2: Delay Time	Delay Time	0–127
LFO2: Fade Time	Fade Time	0–127
LFO2: Offset	Level Offset	-100, -50, 0, +50, +100
LFO2: Pitch Depth	Pitch Depth	-63–+63
LFO2: FilterDepth	Filter Depth	-63–+63
LFO2: Amp Depth	Amplifier Depth	-63–+63
LFO2: Pan Depth	Pan Depth	-63–+63

1*: Note

COMMON section	[EDIT] + KEY PAD [11] (p. 54)	
COM: Struct 1&2 *	Structure Type 1&2	1–10
COM: Struct 3&4 *	Structure Type 3&4	1–10
COM: Booster 1&2 *	Booster Gain 1&2	0, +6, +12, +18
COM: Booster 3&4 *	Booster Gain 3&4	0, +6, +12, +18
COM: Stretch Tune *	Stretch Tune Depth	OFF, 1–3
COM: V-Priority *	Voice Priority	LAST, LOUDEST
COM: Key Range L *	Key Range Lower	C-1–UPR
COM: Key Range U *	Key Range Upper	LWR–G9
COM: Velo Range *	Velocity Range Switch	OFF, ON
COM: Velo Range L	Velocity Range Lower	1–UPR
COM: Velo Range U	Velocity Range Upper	LWR–127
COM: Velo X-Fade	Velocity Crossfade	0–127

*: Common settings for each tone

SOLO/PORTA section	[EDIT] + KEY PAD [12] (p. 58)	
SOLO: Solo SW #*	Solo Switch	OFF, ON
SOLO: Solo Legato *	Solo Legato Switch	OFF, ON
PORTAMENTO: SW #*	Portamento Switch	OFF, ON
PORTAMENTO: Mode *	Portamento Mode	NORMAL, LEGATO
PORTAMENTO: Type *	Portamento Type	RATE, TIME
PORTAMENTO: Start *	Portamento Start Pitch	PITCH, NOTE
PORTAMENTO: Time #*	Portamento Time	0–127

*: Common settings for each tone

CONTROL/MODULATION section	[EDIT] + KEY PAD [13] (p. 60)	
MOD: Control 1	Control Destination1	1*
MOD: Ctrl1 Depth	Control1 Depth	-63–+63
MOD: Control 2	Control Destination2	1*
MOD: Ctrl2 Depth	Control2 Depth	-63–+63
MOD: Control 3	Control Destination3	1*
MOD: Ctrl3 Depth	Control3 Depth	-63–+63
MOD: Control 4	Control Destination4	1*
MOD: Ctrl4 Depth	Control4 Depth	-63–+63

1*: OFF, PCH, CUT, RES, LEV, PAN, L1P, L2P, L1F, L2F, L1A, L2A, L1p, L2p, L1R, L2R

CONTROL/PITCH BEND section	[EDIT] + KEY PAD [14] (p. 60)	
BEND: Bend Up *	Bend Range Up	0–+12
BEND: Bend Down *	Bend Range Down	0–48
BEND: Control 1	Control Destination1	1*
BEND: Ctrl1 Depth	Control1 Depth	-63–+63
BEND: Control 2	Control Destination2	1*
BEND: Ctrl2 Depth	Control2 Depth	-63–+63
BEND: Control 3	Control Destination3	1*
BEND: Ctrl3 Depth	Control3 Depth	-63–+63
BEND: Control 4	Control Destination4	1*
BEND: Ctrl4 Depth	Control4 Depth	-63–+63

*: Common settings for each tone

1*: OFF, PCH, CUT, RES, LEV, PAN, L1P, L2P, L1F, L2F, L1A, L2A, L1p, L2p, L1R, L2R

CONTROL/AFTER TOUCH section	[EDIT] + KEY PAD [15] (p. 60)	
AFT: Control 1	Control Destination1	1*
AFT: Ctrl1 Depth	Control1 Depth	-63–+63
AFT: Control 2	Control Destination2	1*
AFT: Ctrl2 Depth	Control2 Depth	-63–+63
AFT: Control 3	Control Destination3	1*
AFT: Ctrl3 Depth	Control3 Depth	-63–+63
AFT: Control 4	Control Destination4	1*
AFT: Ctrl4 Depth	Control4 Depth	-63–+63

1*: OFF, PCH, CUT, RES, LEV, PAN, L1P, L2P, L1F, L2F, L1A, L2A, L1p, L2p, L1R, L2R

Rhythm Set Parameters

#: Parameters which can also be operated from the front-panel knobs or buttons.

WAVE section		[EDIT] + KEY PAD [1] (p. 64)
WAVE: Tone SW	Rhythm Tone Switch	OFF, ON
WAVE: C#4(61) #	Wave Select	A001–B251
WAVE: Wave Gain	Wave Gain	-6, 0, +6, +12
KEY: Env Mode	Envelope Mode	SUSTAIN, NO-SUS
KEY: Mute Group	Mute Group	OFF, 1–31

PITCH section		[EDIT] + KEY PAD [2] (p. 65)
PITCH: CoarseTune #	Coarse Tune	-48–+48
PITCH: Fine Tune #	Fine Tune	-50–+50
PITCH: Rnd Pitch	Ramdom Pitch Depth	1*

1*: 0, 1, 2, 3, 4, 5, 6, 7, 8, 9, 10, 20, 30, 40, 50, 60, 70, 80, 90, 100, 200, 300, 400, 500, 600, 700, 800, 900, 1000, 1100, 1200

P-ENV section		[EDIT] + KEY PAD [3] (p. 66)
P-ENV: ENV Depth #	Envelope Depth	-12–+12
P-ENV: Velo Sens	Velocity Sens	-100–+150
P-ENV: Velo Time	Velocity Time Sens	1*
P-ENV: [A]Time1 #	Time1 (Attack Time)	0–127
P-ENV: Time2	Time2	0–127
P-ENV: [D]Time3 #	Time3 (Decay Time)	0–127
P-ENV: [R]Time4 #	Time4 (Release Time)	0–127
P-ENV: Level1	Level1	-63–+63
P-ENV: Level2	Level2	-63–+63
P-ENV: [S]Level3 #	Level3 (Sustain Level)	-63–+63
P-ENV: Level4	Level4	-63–+63

1*: -100, -70, -50, -40, -30, -20, -10, 0, +10, +20, +30, +40, +50, +70, +100

FILTER section		[EDIT] + KEY PAD [4] (p. 69)
FILTER: Type	Filter Type	OFF, LPF, BPF, HPF, PKG
FILTER: Cutoff	Cutoff Frequency	0–127
FILTER: Resonance	Resonance	0–127
FILTER: Reso Velo	Resonance Velocity Sens	-100–+150

F-ENV section		[EDIT] + KEY PAD [5] (p. 71)
F-ENV: ENV Depth #	Envelope Depth	-63–+63
F-ENV: Velo Sens	Velocity Sens	-100–+150
F-ENV: Velo Time	Velocity Time Sens	1*
F-ENV: [A]Time1 #	Time1 (Attack Time)	0–127
F-ENV: Time2	Time2	0–127
F-ENV: [D]Time3 #	Time3 (Decay Time)	0–127
F-ENV: [R]Time4 #	Time4 (Release Time)	0–127
F-ENV: Level1	Level1	0–127
F-ENV: Level2	Level2	0–127
F-ENV: [S]Level3 #	Level3 (ustain Level)	0–127
F-ENV: Level4	Level4	0–127

1*: -100, -70, -50, -40, -30, -20, -10, 0, +10, +20, +30, +40, +50, +70, +100

AMPLIFIER/LEVEL section		[EDIT] + KEY PAD [6] (p. 73)
AMP: Tone Level #	Rhythm Tone Level	0–127

AMPLIFIER/PAN section		[EDIT] + KEY PAD [7] (p. 73)
AMP: Tone Pan	Rhythm Tone Pan	L64–63R
AMP: Rnd Pan Sw	Ramdom Pan Switch	OFF, ON
AMP: Alt Pan Dpth	Altenate Pan Depth	L63–63R

A-ENV section		[EDIT] + KEY PAD [8] (p. 74)
A-ENV: Velo Sens	Velocity Sens	-100–+150
A-ENV: Velo Time	Velocity Time Sens	1*
A-ENV: [A]Time1 #	Time1 (Attack Time)	0–127
A-ENV: Time2	Time2	0–127
A-ENV: [D]Time3 #	Time3 (Decay Time)	0–127
A-ENV: [R]Time4 #	Time4 (Release Time)	0–127
A-ENV: Level1	Level1	0–127
A-ENV: Level2	Level2	0–127
A-ENV: [S]Level3 #	Level3 (Sustain Level)	0–127

1*: -100, -70, -50, -40, -30, -20, -10, 0, +10, +20, +30, +40, +50, +70, +100

CONTROL/PITCH BEND section		[EDIT] + KEY PAD [14] (p. 75)
BEND: Bend Range	Bend Range	0–+12

RHY TONE section		[EDIT] + KEY PAD [16] (p. 76)
R.TONE REV Level	Rhythm Tone Reverb Level	0–127
R.TONE DLY Level	Rhythm Tone Delay Level	0–127
R.TONE EFX/Out	Rhythm Tone EFX/Output Assign	DRY, EFX, DIR1, DIR2

Setup Parameters

#: Parameters which can also be operated from the front-panel knobs or buttons.

P: Parameters that are set independently for each part.

PART MIXER section		(p. 24)
Part Level #P	Part Level	0–127
Part Pan #P	Part Pan	L64–63R
Part K-Shift #P	Part Key Shift	-24–+24
Part Reverb #P	Part Reverb Level	0–127
Part Delay #P	Part Delay Level	0–127
Part EFX/Out #P	Part EFX/Output Assign	DRY, EFX, DIR1, DIR2, RHY

REVERB section		[SHIFT] + KEY PAD [5] (p. 81)
Type#	Reverb Type	ROOM1, ROOM2, STAGE1, STAGE2, HALL1, HALL2
Reverb Time#	Reverb Time	0–127
HF Damp#	HF Damp	1*
EFX->Rev Lvl#	EFX -> Reverb Level	0–127
Reverb Level#	Reverb Level	0–127

1*: 200, 250, 315, 400, 500, 630, 800, 1000, 1250, 1600, 2000, 2500, 3150, 4000, 5000, 6300, 8000, BYPASS

DELAY section	[SHIFT] + KEY PAD [6] (p. 85)	
Type #	Delay Type	SHORT, LONG
Delay Time #	Delay Time	S:0.1-275, L:200-1000, 1*
Feedback #	Feedback Level	0-+98
HF Damp	HF Damp	2*
Output	Delay Output Assign	MIX, REV, MIX+REV
EFX->Dly Lvl #	EFX -> Delay Level	0-127
Delay Level #	Delay Level	0-127

1*: Note, 1/16, 1/12, 3/32, 1/8, 1/6, 3/16, 1/4, 1/3, 3/8, 1/2

2*: 200, 250, 315, 400, 500, 630, 800, 1000, 1250, 1600, 2000, 2500, 3150, 4000, 5000, 6300, 8000, BYPASS

EFX section	[SHIFT] + KEY PAD [7] (p. 87)	
Type= 4-BAND-EQ #		
Low Freq	Low Frequency	200, 400
Low Gain #	Low Gain	-15-+15
High Freq	High Frequency	4000, 8000
High Gain #	High Gain	-15-+15
Peak1 Freq	Peaking1 Frequency	1*
Peak1 Q	Peaking1 Q	0.5, 1.0, 2.0, 4.0, 8.0
Peak1 Gain #	Peaking1 Gain	-15-+15
Peak2 Freq	Peaking2 Frequency	1*
Peak2 Q	Peaking2 Q	0.5, 1.0, 2.0, 4.0, 8.0
Peak2 Gain	Peaking2 Gain	-15-+15
Output Level #	Output Level	0-127

1*: 200, 250, 315, 400, 500, 630, 800, 1000, 1250, 1600, 2000, 2500, 3150, 4000, 5000, 6300, 8000

Type= SPECTRUM #		
Low-High #	Low High Gain	-15-+15
Middle Gain #	Middle Gain	-15-+15
Width #	Band Width	1-5
Output Pan	Output Pan	L64-63R
Output Level #	Output Level	0-127

Type= ENHANCER #		
Sens #	Sens	0-127
Mix #	Mix Level	0-127
Low Gain	Low Gain	-15-+15
High Gain #	High Gain	-15-+15
Output Level #	Output Level	0-127

Type= OVERDRIVE #		
Input Level	Input Level	0-127
Drive #	Drive	0-127
AMP Type #	AMP Type	SMALL, BUILTIN, 2STACK, 3STACK
Output Pan #	Output Pan	L64-R63
Output Level #	Output Level	0-127

Type= DISTORTION #		
Input Level	Input Level	0-127
Drive #	Drive	0-127
AMP Type #	AMP Type	SMALL, BUILTIN, 2STACK, 3STACK
Output Pan #	Output Pan	L64-63R
Output Level #	Output Level	0-127

Type= Lo-Fi #		
Bit Down #	Bit Down	0-7
S-Rate Down #	Sample Rate Down	32, 16, 8, 4
Post Gain #	Post Gain	0, +6, +12, +18
Low Gain	Low Gain	-15-+15
High Gain	High Gain	-15-+15
Output	Output	MONO, STEREO
Output Level #	Output Level	0-127

Type= NOISE #		
Noise Type	Noise Type	1-8
Noise Level #	Noise Level	0-127
N Filter #	Noise Filter	1*
Lo-Fi Level #	Lo-Fi Level	0-127
Output Pan	Output Pan	L64-63R
Output Level #	Output Level	0-127

1*: 200, 250, 315, 400, 500, 630, 800, 1000, 1250, 1600, 2000, 2500, 3150, 4000, 5000, 6300, 8000, BYPASS

Type= RADIO-TUNG #		
Radio Detune #	Radio Detune	0-127
Noise Level #	Noise Level	0-127
Low Gain	Low Gain	-15-+15
High Gain #	High Gain	-15-+15
Output	Output	MONO, STEREO
Output Level #	Output Level	0-127

Type= PHONOGRAPH #		
Disc Type	Disc Type	LP, EP, SP
D NoiseLevel #	Disc Noise Level	0-127
Depth #	Depth	0-+20
Output Pan #	Output Pan	L64-63R
Output Level #	Output Level	0-127

Type= COMPRESSOR #		
Attack #	Attack	0-127
Sustain #	Sustain	0-127
Post Gain	Post Gain	0, +6, +12, +18
Low Gain	Low Gain	-15-+15
High Gain #	High Gain	-15-+15
Output Level #	Output Level	0-127

Type= LIMITER #		
Threshold #	Threshold Level	0–127
Ratio #	Compression Ratio	1.5:1, 2:1, 4:1,100:1
Release #	Release	0–127
Post Gain	Post Gain	0, +6, +12, +18
Output Pan	Output Pan	L64–63R
Output Level #	Output Level	0–127

Type= SLICER #		
Timing PTN #	Timing Pattern	1–34
Rate #	Rate	1/4, 1/2, 1/1
Accent PTN #	Accent Pattern	1–16
Accent Level	Accent Level	0–127
Attack	Attack	1–10
Output Level #	Output Level	0–127

Type= TREMOLO #		
LFO Type #	LFO Type	TRI, TRP, SIN, SAW1, SAW2, SQR
Rate #	Rate	0.1–10.0, 1*
Depth #	Depth	0–127
Low Gain	Low Gain	-15–+15
High Gain	High Gain	-15–+15
Output Level #	Output Level	0–127

1*: 1/16, 1/12, 3/32, 1/8, 1/6, 3/16, 1/4, 1/3, 3/8, 1/2, 2/3, 3/4, 1/1, 2MES, 3MES, 4MES, 8MES, 16MES

Type= PHASER #		
Manual	Manual	100–8000
Rate #	Rate	0.1–10.0, 1*
Depth #	Depth	0–127
Resonance #	Resonance	0–127
Mix	Mix Level	0–127
Output Pan	Output Pan	L64–63R
Output Level #	Output Level	0–127

1*: 1/16, 1/12, 3/32, 1/8, 1/6, 3/16, 1/4, 1/3, 3/8, 1/2, 2/3, 3/4, 1/1, 2MES, 3MES, 4MES, 8MES, 16MES

Type= CHORUS #		
Pre Delay	Pre Delay Time	0.0–100
Rate #	Rate	0.1–10.0, 1*
Depth #	Depth	0–127
Phase #	Phase	0–180
Filter Type	Filter Type	OFF, LPF, HPF
Cutoff	Cutoff Frequency	2*
Balance	Effect Balance	D100:0E–D0:100E
Output Level #	Output Level	0–127

1*: 1/16, 1/12, 3/32, 1/8, 1/6, 3/16, 1/4, 1/3, 3/8, 1/2, 2/3, 3/4, 1/1, 2MES, 3MES, 4MES, 8MES, 16MES

2*: 200, 250, 315, 400, 500, 630, 800, 1000, 1250, 1600, 2000, 2500, 3150, 4000, 5000, 6300, 8000

Type= SPACE-D #		
Pre Delay	Pre Delay Time	0.0–100
Rate #	Rate	0.1–10.0, 1*
Depth #	Depth	0–127
Phase #	Phase	0–180
Low Gain	Low Gain	-15–+15
High Gain	High Gain	-15–+15
Balance	Effect Balance	D100:0E–D0:100E
Output Level #	Output Level	0–127

1*: 1/16, 1/12, 3/32, 1/8, 1/6, 3/16, 1/4, 1/3, 3/8, 1/2, 2/3, 3/4, 1/1, 2MES, 3MES, 4MES, 8MES, 16MES

Type= TETRA-CHORS #		
Pre Delay	Pre Delay Time	0.0–100
Rate #	Rate	0.1–10.0, 1*
Depth #	Depth	0–127
Pre Dly Devi	Pre Delay Deviation	0–20
Depth Devi	Depth Deviation	-20–+20
Pan Devi #	Pan Deviation	0–20
Balance	Effect Balance	D100:0E–D0:100E
Output Level #	Output Level	0–127

1*: 1/16, 1/12, 3/32, 1/8, 1/6, 3/16, 1/4, 1/3, 3/8, 1/2, 2/3, 3/4, 1/1, 2MES, 3MES, 4MES, 8MES, 16MES

Type= FLANGER #		
Pre Delay	Pre Delay Time	0.0–100
Rate #	Rate	0.1–10.0, 1*
Depth #	Depth	0–127
Feedback #	Feedback Level	0–+98
Phase	Phase	0–180
Filter Type	Filter Type	OFF, LPF, HPF
Cutoff	Cutoff Frequency	2*
Balance	Effect Balance	D100:0E–D0:100E
Output Level #	Output Level	0–127

1*: 1/16, 1/12, 3/32, 1/8, 1/6, 3/16, 1/4, 1/3, 3/8, 1/2, 2/3, 3/4, 1/1, 2MES, 3MES, 4MES, 8MES, 16MES

2*: 200, 250, 315, 400, 500, 630, 800, 1000, 1250, 1600, 2000, 2500, 3150, 4000, 5000, 6300, 8000

Type= ST-FLANGER #		
Pre Delay	Pre Delay Time	0.0–100
Rate #	Rate	0.1–10.0, 1*
Depth #	Depth	0–127
Feedback	Feedback Level	0–+98
Phase	Phase	0–180
Step Rate #	Step Rate	0.05–10.0, 2*
Balance	Effect Balance	D100:0E–D0:100E
Output Level #	Output Level	0–127

1*: 1/16, 1/12, 3/32, 1/8, 1/6, 3/16, 1/4, 1/3, 3/8, 1/2, 2/3, 3/4, 1/1, 2MES, 3MES, 4MES, 8MES, 16MES

2*: 1/16, 1/12, 3/32, 1/8, 1/6, 3/16, 1/4, 1/3, 3/8, 1/2

Type= SHORT-DELAY #		
Time L #	Delay Time Left	0.1–190
Time R #	Delay Time Right	0.1–190
HF Damp	HF Damp	1*
Feedback #	Feedback Level	0–+98
Auto Pan	Auto Pan	OFF, 2*
Low Gain	Low Gain	-15–+15
High Gain	High Gain	-15–+15
Balance	Effect Balance	D100:0E–D0:100E
Output Level #	Output Level	0–127

1*: 200, 250, 315, 400, 500, 630, 800, 1000, 1250, 1600, 2000, 2500, 3150, 4000, 5000, 6300, 8000, BYPASS

2*: 1/16, 1/12, 3/32, 1/8, 1/6, 3/16, 1/4, 1/3, 3/8, 1/2, 2/3, 3/4, 1/1, 2MES, 3MES, 4MES, 8MES, 16MES

Type= AUTO-PAN #		
LFO Type	LFO Type	TRI, TRP, SIN, SAW1, SAW2, SQR
Rate #	Rate	0.1–10.0, 1*
Bass Sence #	Bass Sens	OFF, MODE1, MODE2
Depth #	Depth	0–127
Low Gain	Low Gain	-15–+15
High Gain	High Gain	-15–+15
Output Level	Output Level	0–127

1*: 1/16, 1/12, 3/32, 1/8, 1/6, 3/16, 1/4, 1/3, 3/8, 1/2, 2/3, 3/4, 1/1, 2MES, 3MES, 4MES, 16MES

Type= FB-P-SHIFT #		
Coarse #	Coarse Pitch	-24–+12
Fine	Fine Pitch	-100–+100
Output Pan #	Output Pan	L64–63R
Pre Delay	Pre Delay Time	0.0–100
Mode	Pitch Shift Mode	1–5
Feedback #	Feedback Level	0–+98
Low Gain	Low Gain	-15–+15
High Gain	High Gain	-15–+15
Balance	Effect Balance	D100:0E–D0:100E
Output Level #	Output Level	0–127

Type= REVERB #		
Rev Type	Reverb Type	ROOM1, ROOM2, STAGE1, STAGE2, HALL1, HALL2
Time #	Reverb Time	0–127
HF Damp #	HF Damp	1*
Balance #	Effect Balance	D100:0E–D0:100E
Output Level #	Output Level	0–127

1*: 200, 250, 315, 400, 500, 630, 800, 1000, 1250, 1600, 2000, 2500, 3150, 4000, 5000, 6300, 8000, BYPASS

Type= GATE-REVERB #		
Gate Type #	Gate Reverb Type	NORMAL, REVRSE, SWEEP1, SWEEP2
Gate Time #	Gate Reverb Time	5–330
Balance #	Effect Balance	D100:0E–D0:100E
Output Level #	Output Level	0–127

SEQ OUT section	[SHIFT]+ KEY PAD [8] (p. 25)	
SEQ Out P	Sequencer Output Assign	INT, EXT, BOTH

Arpeggiator Parameters

#: Parameters which can also be operated from the front-panel knobs or buttons.

ARPEGGIO section	[SHIFT] + KEY PAD [1] (p. 107)	
ARP: Style #	Arpeggio Style	1*
ARP: Accent Rate	Accent Rate	0–127
ARP: Octave Range #	Octave Range	-3+3
ARP: Motif	Motif	2*
ARP: Beat Pattern	Beat Pattern	3*
ARP: Shuffle Rate	Shuffle Rate	50–90%

1*: 1/4, 1/6, 1/8, 1/12, 1/16, 1/32, PORTAMENTO A–B, GRISSANDO, SEQUENCE A–D, ECHO, SYNTH BASS, HEAVY SLAP, LIGHT SLAP, WALK BASS, RHYTHM GTR 1–5, 3 FINGER, STRUMMING GTR, PIANO BACKING, CLAVI CHORD, WALTZ, SWING WALTZ, REGGAE, PERCUSSION, HARP, SHAMISEN, BOUND BALL, RANDOM, BOSSA NOVA, SALSA, MAMBO, LATIN PERCUSSION, SAMBA, TANGO, HOUSE, LIMITLESS, USER TYPE 1–20

2*: SINGLE UP, SINGLE DOWN, SINGLE UP&DOWN, SINGLE RANDOM, DUAL UP, DUAL DOWN, DUAL UP&DOWN, DUAL RANDOM, TRIPLE UP, TRIPLE DOWN, TRIPLE UP&DOWN, TRIPLE RANDOM, NOTE ORDER, GLISSANDO, CHORD, BASS+CHORD 1–5, BASS+UP 1–8, BASS+RND 1–3, TOP+UP 1–6, BASS+UP+TOP

3*: 1/4, 1/6, 1/8, 1/12, 1/16 1–3, 1/32 1–3, PORTA-A 1–11, PORTA-B 1–15, SEQ-A 1–7, SEQ-B 1–5, SEQ-C 1–2, SEQ-D 1–8, ECHO 1–3, MUTE 1–16, STRUM 1–8, REGGAE 1–2, REF 1–2, PERC 1–4, WALKBS, HARP, BOUND, RANDOM, BOSSA NOVA, SALSA 1–4, MAMBO 1–2, CLAVE, REV CLA, GUILO, AGOGO, SAMBA, TANGO 1–4, HOUSE 1–2

Play Quantize Parameters

#: Parameters which can also be operated from the front-panel knobs or buttons.

GRID section	[SHIFT] + KEY PAD [2] (p. 113)	
Resolution #	Resolution	1/4, 1/6, 1/8, 1/12, 1/16, 1/24, 1/32
Strength #	Strength	0–100%

GROOVE section	[SHIFT] + KEY PAD [3] (p. 115)	
Groove Template #	Groove Template	01–71
Strength #	Strength	0–100%
Velocity #	Velocity Strength	0–100%

SHUFFLE section	[SHIFT] + KEY PAD [4] (p. 114)	
Resolution #	Resolution	1/12, 1/24
ShuffleRate #	Shuffle Rate	0–100%

System Parameters

P: Parameters that are set independently for each part.

TUNE/SOUND section	[SHIFT] + KEY PAD [9] (p. 163)	
MasterTune	Master Tune	427.4–452.6
ScaleTune SW	Scale Tune Switch	OFF, ON
ScaleTune C–B	Scale Tune C–B	-64+63
Patch Remain	Patch Remain	OFF, ON
V-Reserve P	Voice Reserve	0–64
Reso Limit-R	Resonance Limiter R	50–127
Reso Limit-N	Resonance Limiter N	50–127
CONTROLLER section	[SHIFT] + KEY PAD [10] (p. 164)	
LCD Contrast	LCD Contrast	1–10
Pad Velocity	LCD Contrast	1–127
Pdl Assign	Pedal Assign	HOLD, SHIFT, FUNC, PTN-I, TAP, R-TPS, PLAY, BEAM, SOSTE
Pdl Pol	Contrast Polarity	STANDARD, REVERSE
BeamPol	Beam Polarity	STANDARD, REVERSE
Beam Assign1	Beam Assign1	01–28
Beam Assign2	Beam Assign2	01–28
Beam Assign3	Beam Assign3	01–28
Beam Range L	Beam Range Lower	0–UPR
Beam Range U	Beam Range Upper	LWR–127
SEQUENCER section	[SHIFT] + KEY PAD [11] (p. 166)	
Sync Mode	Sync Mode	INT, SLAVE, REMOTE
Sync Out	Sync Out	OFF, ON
Thru	Thru	OFF, ON
Loop Mode	Loop Mode	OFF, LOOP1, LOOP2
Metro Level	Metronome Level	0–127
RPS T-QTZ	RPS Trigger Quantize	REAL, 16, 8, 4, MES
ARPG Sync	Arpeggio Sync	OFF, ON
AutoCheckSum	Auto CheckSum	OFF, ON
Tap SW	Tap Switch	OFF, ON
Tap Resolution	Tap Resolution	1/4, 1/8
MIDI section	[SHIFT] + KEY PAD [12] (p. 168)	
Remote Kbd	Remote Keyboard Switch	OFF, ON
Device ID	Device ID Number	17–32
MIDI Rx SW P	MIDI Rx Switch	OFF, ON
LocalTx P	LocalTx Switch	INT, EXT, BOTH
Arpg Ctrl Ch	Arpeggio Control Ch	OFF, 1–16
RPS Ctrl Ch	RPS Control Ch	OFF, 1–16
Edit TxRx	Edit TxRx Mode	MODE1, MODE2
Rx.PG	Receive Program Change Switch	OFF, ON
Rx.Bank Sel	Receive Bank Select Switch	OFF, ON
Rx.Sys-Ex	Receive System Exclusive Switch	OFF, ON
Tx.PG	Transmit Program Change Switch	OFF, ON
Tx.Bank Sel	Transmit Bank Select Switch	OFF, ON
Tx.A-Sens	Transmit Active Sensing Switch	OFF, ON

Transmit/Receive Setting List

	Parameter	MODE1 (Factory setting)	MODE2	Value
PITCH Section	COARSE TUNE	EXCLUSIVE	CC#21	16–112 (Center=64) *1
	FINE TUNE	CC#77	CC#77	14–114 (Center=64) *1
FILTER Section	FILTER TYPE	EXCLUSIVE	CC#34	0–4 *1
	CUTOFF	CC#74	CC#74	0–127 *1
	RESONANCE	CC#71	CC#71	0–127 *1
AMPLIFIER Section	TONE LEVEL	EXCLUSIVE	CC#36	0–127 *1
	TONE PAN	EXCLUSIVE	CC#35	0–127 (Center=64) *1
	RND PAN	EXCLUSIVE	CC#37	0 (OFF), 63 (ON) *1
P-ENVELOPE Section	DEPTH	EXCLUSIVE	CC#25	52–76 (Center=64) *1
	A	EXCLUSIVE	CC#26	0–127 *1
	D	EXCLUSIVE	CC#27	0–127 *1
	S	EXCLUSIVE	CC#39	0–127 (Center=64) *1
	R	EXCLUSIVE	CC#40	0–127 *1
F-ENVELOPE Section	DEPTH	CC#81	CC#81	1–127 (Center=64) *1
	A	CC#82	CC#82	0–127 *1
	D	CC#83	CC#83	0–127 *1
	S	EXCLUSIVE	CC#28	0–127 *1
	R	EXCLUSIVE	CC#29	0–127 *1
A-ENVELOPE Section	A	CC#73	CC#73	0–127 *1
	D	CC#75	CC#75	0–127 *1
	S	EXCLUSIVE	CC#31	0–127 *1
	R	CC#72	CC#72	0–127 *1
LFO1 Section	WAVEFORM	EXCLUSIVE	CC#15	0–7 *1
	RATE	CC#16	CC#16	0–127 *1
	P-DEPTH	CC#18	CC#18	1–127 (Center=64) *1
	F-DEPTH	CC#19	CC#19	1–127 (Center=64) *1
	A-DEPTH	CC#80	CC#80	1–127 (Center=64) *1
PORTAMENTO Section	ON	CC#65	CC#65	0–63 (OFF), 64 –127 (ON)
	TIME	CC#5	CC#5	0–127
	SOLO	CC#126/127	CC#126/127	126=1 (ON), 127=0 (OFF)
PART MIXER Section	LEVEL	CC#7	CC#7	0–127
	PAN	CC#10	CC#10	0–127 (Center=64)
	KEY SHIFT	EXCLUSIVE	CC#85	16–112 (Center=64)
	REVERB	CC#91	CC#91	0–127
	DELAY	CC#94	CC#94	0–127
	EFX/OUT	EXCLUSIVE	CC#86	0–4

*1 When [TONE SELECT] is lit so that parameter values are transmitted for each tone, system exclusive is used for transmission regardless of the mode.

* The parameters for each knob of the Reverb section, Delay section and EFX section are transmitted and received as system exclusive messages regardless of the mode.

MIDI Implementation

Model: MC-505(Groove Box)
Date: Oct. 30 1997
Version: 1.00

Symbol	Description	Range
n	MIDI Channel	0H-FH (ch.1~ch.16)
vv	Control value	00H-7FH (0-127)
kk	Note Number	00H-7FH (0-127)
xx	ON/OFF	00H-3FH (0-63:OFF), 40H-7FH (64-127:ON)

1. MIDI messages used by the sound source section

■ Channel voice messages

● Note Off

status	2nd byte	3rd byte
8nH	kkH	vvH
9nH	kkH	00H

- * Not received when the Rx SW paramete is OFF.
- * Not received by the Rhythm Part when the Envelope Mode parameter is NO-SUS.

● Note On

status	2nd byte	3rd byte
9nH	kkH	vvH

- * Not received when the Rx SW paramete is OFF.

● Polyphonic Aftertouch

status	2nd byte	3rd byte
AnH	kkH	vvH

- * Not received when the Rx SW parameter is OFF.

● Control Change

- * Not received when the Rx SW parameter is OFF.

○ Bank Select (Controller number 0,32)

status	2nd byte	3rd byte
BnH	00H	mmH
BnH	20H	llH

mm,ll=Bank number: 00 00H-7F 7FH (bank.1~bank.16384)

- * Not received when the Rx Program Change or Rx Bank Select parameter is OFF.
- * The Patches corresponding to each Bank Select are as follows.

Bank Select		Program No	Group	Patch No.
MSB	LSB			
81	0	1 - 128	Preset-A	001 - 128
81	1	1 - 128	Preset-B	001 - 128
81	2	1 - 128	Preset-C	001 - 128
81	3	1 - 128	Preset-D	001 - 128
85	0	1 - 128	User-A	001 - 128
85	1	1 - 128	User-B	001 - 128
86	0	1 - 128	Card-A	001 - 128
86	1	1 - 128	Card-B	001 - 128
86	2	1 - 128	Card-C	001 - 128
86	3	1 - 128	Card-D	001 - 128

- * The Rhythm set corresponding to each Bank Select are as follows.

Bank Select		Program No	Group	Patch No.
MSB	LSB			
81	0	1 - 26	Preset	01 - 26
85	0	1 - 20	User	01 - 20
86	0	1 - 20	Card	01 - 20

○ Modulation (Controller number 1)

status	2nd byte	3rd byte
BnH	01H	vvH

○ Breath type (Controller number 2)

status	2nd byte	3rd byte
BnH	02H	vvH

○ Foot type (Controller number 4)

status	2nd byte	3rd byte
BnH	04H	vvH

○ Portamento Time (Controller number 5)

status	2nd byte	3rd byte
BnH	05H	vvH

- * The Portamento Time parameter will change.

○ Data Entry (Controller number 6,38)

status	2nd byte	3rd byte
BnH	06H	mmH
BnH	26H	llH

mm,ll= the value of the parameter specified by RPN mm=MSB, ll=LSB

○ Volume (Controller number 7)

status	2nd byte	3rd byte
BnH	07H	vvH

○ Balance (Controller number 8)

status	2nd byte	3rd byte
BnH	08H	vvH

○ Panpot (Controller number 10)

status	2nd byte	3rd byte
BnH	0AH	vvH

- * Adjust the stereo location over 128 steps, where 0 is far left, 64 is center, and 127 is far right.

○ Expression (Controller number 11)

status	2nd byte	3rd byte
BnH	0BH	vvH

○ General purpose Controller1-4 (Controller number 16-19)

status	2nd byte	3rd byte
BnH	10H-13H	vvH

○ Hold 1 (Controller number 64)

status	2nd byte	3rd byte
BnH	40H	xxH

○ Portamento (Controller number 65)

status	2nd byte	3rd byte
BnH	41H	xxH

○ Sostenuato (Controller number 66)

status	2nd byte	3rd byte
BnH	42H	xxH

○ Soft (Controller number 67)

status	2nd byte	3rd byte
BnH	43H	xxH

○ Sound Controller1-10 (Controller number 70-79)

status	2nd byte	3rd byte
BnH	46-4FH	vvH

○ General purpose Controller5-8 (Controller number 80-83)

status	2nd byte	3rd byte
BnH	50H-53H	vvH

○ Portamento Control (Controller number 84)

status	2nd byte	3rd byte
BnH	54H	kkH

- * A Note On message received immediately after a Portamento control will be sounded with the pitch changing smoothly from the source note number. If a voice is already sounding at the same note number as the source note number, that voice will change pitch to the pitch of the newly received Note On, and continue sounding (i.e., will be played legato).

- * The speed of the pitch change caused by Portamento is determined by the Portamento Time parameter.

○ **Effect 1 (Reverb Send Level) (Controller number 91)**

status	2nd byte	3rd byte
BnH	5BH	vvH

○ **Effect 4 (Reverb Send Level)(Controller number 94)**

status	2nd byte	3rd byte
BnH	5EH	vvH

○ **RPN MSB/LSB (Controller number 100,101)**

status	2nd byte	3rd byte
BnH	65H	mmH
BnH	64H	llH

mm=MSB of the parameter number specified by RPN
ll=LSB of the parameter number specified by RPN

<<< RPN >>

Control Changes include RPN (Registered Parameter Numbers), which are extended parameters whose function is defined in the MIDI specification.

When using RPNs, first the RPN (Controller numbers 100 and 101; they can be sent in any order) is transmitted to specify the parameter you wish to control. Then, Data Entry messages (Controller numbers 6 and 38) are used to set the value of the specified parameter. Once a RPN parameter has been specified, all further Data Entry messages on that channel are considered to apply to that specified parameter. In order to prevent accidents, when the desired setting has been made for the parameter, it is recommended that RPN be set to Null.

This device receives the following RPNs.

RPN	Data entry	Notes
<u>MSB LSB</u> 00H 00H	<u>MSB LSB</u> mmH —	Pitch Bend Sensitivity mm : 00H–0CH (0–12 semitones) ll : ignored (processed as 00H) Up to 1 octave can be specified in semitone steps. * The Bend Range up parameter, Bend Range Down parameter will also be changed. * Not received by the Rhythm Part.
00H 01H	mmH llH	Master Fine Tuning mm, ll: 20 00H–40 00H–60 00H (-8192 *50 / 8192–0→8192 * 50 / 8192 cent) * The Fine Tune parameter of each Part will change.
00H 02H	mmH —	Master Coarse Tuning mm : 10H–40H–70H (-48–0→+48 semitones) ll : ignored (processed as 00H) * The Coarse Tune parameter of each Part will change.
7FH 7FH	— —	RPN null RPN and NRPN will be set as “unspecified”. Once this setting has been made, subsequent Data Entry messages will be ignored. (It is not necessary to transmit Data Entry for RPN Null settings. Parameter values that were previously set will not change. mm, ll: ignored

● **Program Change**

status	2nd byte
CnH	ppH

pp=Program number: 00H–7FH (prog.1–prog.128)

- * Not received when the Rx Program Change parameter is OFF.
- * Not received when the Rx SW parameter is OFF.

● **Channel Aftertouch**

status	2nd byte
DnH	vvH

- * Not received when the Rx SW parameter is OFF.

● **Pitch Bend Change**

status	2nd byte	3rd byte
EnH	llH	mmH

mm,ll=Pitch Bend value: 00 00H–40 00H–7F 7FH (-8192–0→+8191)

- * Not received when the Rx SW parameter is OFF.

■ **Channel Mode messages**

● **All Sound Off (Controller number 120)**

status	2nd byte	3rd byte
BnH	78H	00H

- * When this message is received, all notes currently sounding on the corresponding channel will be turned off.
- * Not received when the Rx SW parameter is OFF.

● **Reset All Controllers (Controller number 121)**

status	2nd byte	3rd byte
BnH	79H	00H

- * Not received when the Rx SW parameter is OFF.
- * When this message is received, the following controllers will be set to their reset values.

Controller	Reset value
Pitch Bend Change	±0 (center)
Polyphonic Key Pressure	0 (off)
Channel Pressure	0 (off)
Modulation	0 (off)
Breath type	0 (minimum)
Expression	127 (maximum)
	However the controller will be at minimum.
Hold 1	0 (off)
Sostenuto	0 (off)
Soft	0 (off)
Hold 2	0 (off)
RPN	Unset. Previously set data will not change.
NRPN	Unset. Previously set data will not change.
System General purpose controller 1	0 (minimum)
System General purpose controller 2	0 (minimum)

● **All Note Off (Controller number 123)**

status	2nd byte	3rd byte
BnH	7BH	00H

- * When All Note Off is received, all currently sounding notes of the corresponding channel will be turned off. However if Hold 1 or Sostenuto are on, the sound will be held until these are turned off.
- * Not received when the Rx SW parameter is OFF.

● **Omni Off (Controller number 124)**

status	2nd byte	3rd byte
BnH	7CH	00H

- * The same processing as when All Note Off is received will be done.
- * Not received when the Rx SW parameter is OFF.

● **Omni On (Controller number 125)**

status	2nd byte	3rd byte
BnH	7DH	00H

- * The same processing as when All Note Off is received will be done. The instrument will not be set to OMNI ON.
- * Not received when the Rx SW parameter is OFF.

● **Mono (Controller number 126)**

status	2nd byte	3rd byte
BnH	7EH	mmH

mm=Mono number: 00H–10H (0–16)

- * The same processing as when All Note Off is received will be done, and the Key Assign parameter will be set to SOLO.
- * Not received when the Rx SW parameter is OFF.

● **Poly (Controller number 127)**

status	2nd byte	3rd byte
BnH	7FH	00H

- * The same processing as when All Note Off is received will be done, and the Key Assign parameter will be set to POLY.
- * Not received when the Rx SW parameter is OFF.

■ System Realtime messages

● Timing Clock

status
F8H

* This is received when Sync Mode is SLAVE. Settings can be made to synchronize the effect rate or the LFO rate.

● Active Sensing

status
FEH

* When an Active Sensing message is received, the unit will begin monitoring the interval at which MIDI messages are received. During monitoring, if more than 420 ms passes without a message being received, the same processing will be done as when All Sound Off, All Note Off, and Reset All Controllers messages are received. Then monitoring will be halted.

■ System Exclusive messages

status data byte status
F0H iiH, ddH,, eeH F7H

F0H: System Exclusive message status
ii = ID number: This is the ID number (manufacturer ID) that specifies the manufacturer whose exclusive message this is. Roland's manufacturer ID is 41H. ID numbers 7EH and 7FH are defined in an expansion of the MIDI standard as Universal Non-realtime messages (7EH) and Universal Realtime Messages (7FH).
dd, ..., ee = data: 00H-7FH (0-127)
F7H: EOX (End Of Exclusive) This is the last status of system exclusive message.

● Universal Non-realtime System Exclusive Messages

○ Inquiry Request Message

Status Data byte Status
F0H 7FH, dev, 06H, 01H F7H

Byte	Explanation
FOH	Exclusive status
7FH	ID number (universal non-realtime message)
dev	Device ID (dev:10H(17)-1FH(32))
06H	Sub ID#1 (General Information)
01H	Sub ID#2 (Inquiry Request)
F7H	EOX (End Of Exclusive)

* The "dev" is own device number or 7FH (Broadcast)
* When Inquiry Request is received, Inquiry Reply message will be transmitted.

○ Inquiry Reply

Status Data byte Status
F0H 7EH, dev, 06H, 02H, 41H, 0BH, 01H, 00H, 00H, 00H, 03H, 00H, 00H F7H

Byte	Explanation
FOH	Exclusive status
7EH	ID number (universal non-realtime message)
dev	Device ID (dev:10H(17)-1FH(32))
06H	Sub ID#1 (General Information)
02H	Sub ID#2 (Inquiry Reply)
41H	ID number (Roland)
0BH 01H	Device family code
00H 00H	Device family number code
00H 03H 00H 00H	Software revision level
F7H	EOX (End of Exclusive)

* Reply the message by the unique device ID (dev) when the device has received the "Inquiry Request Message" in the Broadcast.

● Data Request 1 RQ1

This message requests the other device to transmit data. The address and size indicate the type and amount of data that is requested.
When a Data Request message is received, if the device is in a state in which it is able to transmit data, and if the address and size are appropriate, the requested data is transmitted as a Data Set 1 (DT1) message. If the conditions are not met, nothing is transmitted.
The model ID of the exclusive messages used by this instrument is 00 0BH.

status data byte status
F0H 41H, dev, 00H, 0BH, 11H, aaH, bbH, ccH, ddH, ssH, ttH, uuH, sum F7H

Byte	Remarks
F0H	Exclusive status
41H	ID number (Roland)
dev	device ID (dev: 10H-1FH)
00H	model ID (MC-505)
0BH	model ID (MC-505)
11H	command ID (RQ1)
aaH	address MSB
bbH	address
ccH	address
ddH	address LSB
ssH	size MSB
ttH	size
uuH	size
vvH	size LSB
sum	checksum
F7H	EOX (End Of Exclusive)

* For the address, size, and checksum, refer to "Examples of system exclusive messages and calculating the checksum" (p. 249).
* This message is not received if the Rx.Sys-Ex parameter is OFF.

● Data Set 1 DT1

This message transmits the actual data, and is used when you wish to set the data of the receiving device.

status data byte status
F0H 41H, dev, 00H, 0BH, 12H, aaH, bbH, ccH, ddH, eeH, ... ffH, sum F7H

Byte	Remarks
FOH	Exclusive status
41H	ID number (Roland)
dev	device ID (dev: 10H-1FH)
00H	model ID (MC-505)
0BH	model ID (MC-505)
12H	command ID (DT1)
aaH	address MSB
bbH	address
ccH	address
ddH	address LSB
eeH	data: The actual data to be transmitted. Multi-byte data is transmitted in the order of the address.
:	:
ffH	data
sum	checksum
F7H	EOX (End Of Exclusive)

* For the address, size, and checksum, refer to "Examples of system exclusive messages and calculating the checksum" (p. 249).
* Data whose size is greater than 128 bytes should be divided into packets of 128 bytes or less and transmitted. Successive "Data Set 1" messages should have at least 20 ms of time interval between them.
* This message is not received if the Rx.Sys-Ex parameter is OFF.

The only GS exclusive messages received by the MC-505 are Scale Tune settings (p. 246).

● Data Set 1 DT1

<u>status</u>	<u>data byte</u>	<u>status</u>
F0H	41H, dev, 42, 12H, aaH, bbH, ccH, ddH, eeH, ... ffH, sum	F7H
<u>Byte</u>	<u>Remarks</u>	
F0H	Exclusive status	
41H	ID number (Roland)	
dev	device ID (dev: 10H–1FH)	
42H	model ID (GS)	
12H	command ID (DT1)	
aaH	address MSB	
bbH	address	
ccH	address	
ddH	address LSB	
eeH	data: The actual data to be transmitted. Multi-byte data is transmitted in the order of the address.	
:	:	
ffH	data	
sum	checksum	
F7H	EOX (End Of Exclusive)	

- * For the address, size, and checksum, refer to “Examples of system exclusive messages and calculating the checksum” (p. 249).
- * Data whose size is greater than 128 bytes should be divided into packets of 128 bytes or less and transmitted. Successive “Data Set 1” messages should have at least 20 ms of time interval between them.

In addition to conventional system exclusive messages, the MC-505 also uses special system exclusive messages for operations which require realtime handling, such as knobs.

● Data Set 1 DT1

<u>status</u>	<u>data byte</u>	<u>status</u>
F0H	41H, dev, 42, 12H, aaH, bbH, ccH, ddH, eeH, ... ffH, sum	F7H
<u>Byte</u>	<u>Remarks</u>	
F0H	Exclusive status	
41H	ID number (Roland)	
dev	device ID (dev: 10H–1FH)	
3AH	model ID (MC-505 Quick)	
12H	command ID (DT1)	
aaH	address (Status/Channel)	
bbH	address/Data H	
ccH	Data L	
ddH	Data E	
sum	checksum	
F7H	EOX (End Of Exclusive)	

- * For the address, size, and checksum, refer to “Examples of system exclusive messages and calculating the checksum” (p. 249).
- * Transmission of consecutive addresses is not possible.

2. MIDI messages used by the sequencer section

2.1 Messages recorded during recording

■ Channel voice messages

● Note Off

<u>status</u>	<u>2nd byte</u>	<u>3rd byte</u>
8nH	kkH	vvH
9nH	kkH	00H

● Note On

<u>status</u>	<u>2nd byte</u>	<u>3rd byte</u>
9nH	kkH	vvH

● Polyphonic Aftertouch

<u>status</u>	<u>2nd byte</u>	<u>3rd byte</u>
AnH	kkH	vvH

● Control Change

<u>status</u>	<u>2nd byte</u>	<u>3rd byte</u>
BnH	kkH	vvH
kk=control number:		00H–78H (0–120)

● Program Change

<u>status</u>	<u>2nd byte</u>	
CnH	ppH	
pp=Program number:		00H–7FH (prog.1–prog.128)

● Channel Aftertouch

<u>status</u>	<u>2nd byte</u>	
DnH	vvH	

● Pitch Bend Change

<u>status</u>	<u>2nd byte</u>	<u>3rd byte</u>
EnH	llH	mmH
mm,ll=Pitch Bend value:		00 00H–40 00H–7F 7FH (–8192–0–+8191)

■ Channel Mode messages

● All Sound Off (Controller number 120)

<u>status</u>	<u>2nd byte</u>	<u>3rd byte</u>
BnH	78H	00H

● Reset All Controllers (Controller number 121)

<u>status</u>	<u>2nd byte</u>	<u>3rd byte</u>
BnH	79H	00H

● Omni Off (Controller number 124)

<u>status</u>	<u>2nd byte</u>	<u>3rd byte</u>
BnH	7CH	00H

- * The same processing will be done as when an All Note Off message is received.

● Omni On (Controller number 125)

<u>status</u>	<u>2nd byte</u>	<u>3rd byte</u>
BnH	7DH	00H

- * The same processing will be done as when an All Note Off message is received.

● Mono (Controller number 126)

<u>status</u>	<u>2nd byte</u>	<u>3rd byte</u>
BnH	7EH	mmH
mm=mono number		: 00H–10H (0–16)

- * The same processing will be done as when an All Note Off message is received.

● Poly (Controller number 127)

<u>status</u>	<u>2nd byte</u>	<u>3rd byte</u>
BnH	7FH	00H

■ System Exclusive messages

<u>status</u>	<u>data byte</u>	<u>status</u>
F0H	iiH, ddH,, eeH	F7H

F0H: System Exclusive message status
ii = ID number: This is the ID number (manufacturer ID) that specifies the manufacturer whose exclusive message this is. Roland's manufacturer ID is 41H. ID numbers 7EH and 7FH are defined in an expansion of the MIDI standard as Universal Non-realtime messages (7EH) and Universal Realtime Messages (7FH).
dd, ..., ee = data: 00H-7FH (0-127)
F7H: EOX (End Of Exclusive)

2.2 Messages not recorded during recording

■ Channel Mode messages

● Local On/Off (Controller number 122)

<u>status</u>	<u>2nd byte</u>	<u>3rd byte</u>
BnH	7AH	00H

vv=value: 00H, 7FH (Local off, Local on)

● All Note Off (Controller number 123)

<u>status</u>	<u>2nd byte</u>	<u>3rd byte</u>
BnH	7BH	00H

* When an All Note Off message is received, all notes of the corresponding channel that are on will be sent Note Off's, and the resulting Note Off messages will be recorded.

2.3 Messages acknowledged for synchronization

■ System Common messages

● Song Position Pointer

<u>status</u>	<u>2nd byte</u>	<u>3rd byte</u>
F2H	mmH	llH

mm, ll=value: 00 00H-7F 7FH (0-16383)

■ System Realtime messages

● Timing Clock

<u>status</u>
F8H

* This message will be received if the Sync Mode parameter is SLAVE.

● Start

<u>status</u>
FAH

* This message will be received if the Sync Mode parameter is SLAVE or REMOTE.

● Continue

<u>status</u>
FBH

* This message will be received if the Sync Mode parameter is SLAVE or REMOTE.

● Stop

<u>status</u>
FCH

* This message will be received if the Sync Mode parameter is SLAVE or REMOTE.

2.4 Data transmission (Sequencer section)

2.4.1 Recorded messages are transmitted during playback.

2.4.2 If the Through parameter is ON, messages received (except for System Common messages and System Realtime messages) will be transmitted.

2.4.3 Messages that are generated and transmitted

2.4.3.1 Messages automatically generated by the system

■ Channel Mode messages

● Omni Off (Controller number 124)

<u>status</u>	<u>2nd byte</u>	<u>3rd byte</u>
BnH	7CH	00H

* At start-up, this message is transmitted to all channels.

● Poly (Controller number 127)

<u>status</u>	<u>2nd byte</u>	<u>3rd byte</u>
BnH	7FH	00H

* At start-up, this message is transmitted to all channels.

2.4.3.2 Messages generated and transmitted when the Sync Out is ON

■ System Common messages

● Song Position Pointer

<u>status</u>	<u>2nd byte</u>	<u>3rd byte</u>
F2H	mmH	llH

mm, ll=value: 00 00H-7F 7FH (0-16383)

■ System Realtime messages

● Timing Clock

<u>status</u>
F8H

● Start

<u>status</u>
FAH

● Continue

<u>status</u>
FBH

● Stop

<u>status</u>
FCH

3. Parameter address map

1.MC-505 (Model ID=00H 0BH)

- * For addresses marked by #, the data is transmitted in two parts. For example, the hexadecimal data ABH would be divided into 0AH and 0BH, and transmitted in this order.
- * Addresses for which the Description field is listed as "Reserve" have no meaning for the MC-505. They will be ignored.

Start Address	Description	
00 00 00 00	System	1-1
01 00 00 00	Part Info	1-2
02 00 00 00	Temporary Patch(part 1)	1-3
02 01 00 00	Temporary Patch(part 2)	
:		
02 06 00 00	Temporary Patch(part 7)	
02 09 00 00	Temporary Rhythm Setup	1-4
30 00 00 00	Temporary Pattern Setup	
40 00 00 00	Temporary Pattern Body	

■ 1-1.System

Offset Address	Description	
00 00	System Common	1-1-1
10 00	Part 1 Scale Tune	1-1-2
11 00	Part 2 Scale Tune	
:		
16 00	Part 7 Scale Tune	
19 00	Part R Scale Tune	

■ 1-1-1.System Common

Offset Address	Size	Description	Data (Value)
00 00-00 05	0aaa aaaa	Reserve	--
00 06	0aaa aaaa	Master Tune	0 - 126 *1
00 07	0000 000a	Scale Tune Switch	0 - 1 (OFF,ON)
00 08	0000 000a	EFX Switch	0 - 1 (OFF,ON)
00 09	0000 000a	Delay Switch	0 - 1 (OFF,ON)
00 0A	0000 000a	Reverb Switch	0 - 1 (OFF,ON)
00 0B	0000 000a	Patch Remain	0 - 1 (OFF,ON)
00 0C	0000 000a	Clock Source	0 - 1 (INT,MIDI)
00 0D-00 13	0aaa aaaa	Reserve	--
00 14	0000 000a	Receive Program Change	0 - 1 (OFF,ON)
00 15	0000 000a	Receive Bank Select	0 - 1 (OFF,ON)
00 16	0000 000a	Receive Control Change	0 - 1 (OFF,ON)
00 17	0000 000a	Receive Modulation	0 - 1 (OFF,ON)
00 18	0000 000a	Receive Volume	0 - 1 (OFF,ON)
00 19	0000 000a	Receive Hold-1	0 - 1 (OFF,ON)
00 1A	0000 000a	Receive Pitch Bend	0 - 1 (OFF,ON)
00 1B	0000 000a	Receive Aftertouch	0 - 1 (OFF,ON)
00 1C-00 27	0aaa aaaa	Reserve	--
00 28	0000 000a	Transmit Program Change	0 - 1 (<OFF,ON>)
00 29	0000 000a	Transmit Bank Select	0 - 1 (<OFF,ON>)
00 2A-00 5F	0aaa aaaa	Reserve	--
# 00 60	0000 aaaa 0000 bbbb	System Tempo	20 - 250
Total size	00 00 00 62		

*1: 427.4-452.6

■ 1-1-2.Scale Tune

Offset Address	Size	Description	Data (Value)
00 00	0aaa aaaa	Scale Tune for C	0 - 127 (-64 - +63)
00 01	0aaa aaaa	Scale Tune for C#	0 - 127 (-64 - +63)
00 02	0aaa aaaa	Scale Tune for D	0 - 127 (-64 - +63)
00 03	0aaa aaaa	Scale Tune for Eb	0 - 127 (-64 - +63)
00 04	0aaa aaaa	Scale Tune for E	0 - 127 (-64 - +63)
00 05	0aaa aaaa	Scale Tune for F	0 - 127 (-64 - +63)
00 06	0aaa aaaa	Scale Tune for F#	0 - 127 (-64 - +63)
00 07	0aaa aaaa	Scale Tune for G	0 - 127 (-64 - +63)
00 08	0aaa aaaa	Scale Tune for G#	0 - 127 (-64 - +63)
00 09	0aaa aaaa	Scale Tune for A	0 - 127 (-64 - +63)
00 0A	0aaa aaaa	Scale Tune for A#	0 - 127 (-64 - +63)
00 0B	0aaa aaaa	Scale Tune for B	0 - 127 (-64 - +63)
Total size	00 00 00 0C		

■ 1-2.Part Info

Offset Address	Description	
00 00	Part Info Common	1-2-1
10 00	Part Info Part 1	1-2-2
11 00	Part Info Part 2	
:		
19 00	Part Info Part R	

1-2-1.Part Info Common

Offset	Address	Size	Description	Data (Value)	
00	00-00	0C	0aaa aaaa	Reserve	--
	00	0D	00aa aaaa	EFX Type	0 - 23
	00	0E	0aaa aaaa	EFX Parameter 1	0 - 127
	00	0F	0aaa aaaa	EFX Parameter 2	0 - 127
	00	10	0aaa aaaa	EFX Parameter 3	0 - 127
	00	11	0aaa aaaa	EFX Parameter 4	0 - 127
	00	12	0aaa aaaa	EFX Parameter 5	0 - 127
	00	13	0aaa aaaa	EFX Parameter 6	0 - 127
	00	14	0aaa aaaa	EFX Parameter 7	0 - 127
	00	15	0aaa aaaa	EFX Parameter 8	0 - 127
	00	16	0aaa aaaa	EFX Parameter 9	0 - 127
	00	17	0aaa aaaa	EFX Parameter 10	0 - 127
	00	18	0aaa aaaa	EFX Parameter 11	0 - 127
	00	19	0aaa aaaa	EFX Parameter 12	0 - 127
	00	1A	0000 00aa	Reserve	--
	00	1B	0aaa aaaa	Reserve	--
	00	1C	0aaa aaaa	EFX Delay Send Level	0 - 127
	00	1D	0aaa aaaa	EFX Reverb Send Level	0 - 127
00	1E-00	21	0aaa aaaa	Reserve	--
	00	22	0aaa aaaa	Delay Level	0 - 127
	00	23	0000 000a	Delay Type	0 - 1 *1
	00	24	0aaa aaaa	Delay HFDMP	0 - 17
	00	25	0aaa aaaa	Delay PreDelay	0 - 120
	00	26	0aaa aaaa	Delay Feedback	0 - 98
	00	27	0000 00aa	Delay Output	0 - 2 *2
	00	28	0000 0aaa	Reverb Type	0 - 7 *3
	00	29	0aaa aaaa	Reverb Level	0 - 127
	00	2A	0aaa aaaa	Reverb Time	0 - 127
	00	2B	000a aaaa	Reverb HF Damp	0 - 17 *4
	00	2C	0aaa aaaa	Reserve	--
#	00	2D	0000 aaaa	Part Info Tempo	20 - 250
	00	2F	0000 bbbb 0000 000a	Keyboard Range Switch	0 - 1 (OFF,ON)
	00	30	0aaa aaaa	Voice Reserve 1	0 - 64
	00	31	0aaa aaaa	Voice Reserve 2	0 - 64
	00	32	0aaa aaaa	Voice Reserve 3	0 - 64
	00	33	0aaa aaaa	Voice Reserve 4	0 - 64
	00	34	0aaa aaaa	Voice Reserve 5	0 - 64
	00	35	0aaa aaaa	Voice Reserve 6	0 - 64
	00	36	0aaa aaaa	Voice Reserve 7	0 - 64
00	37-00	38	0aaa aaaa	Reserve	--
	00	39	0aaa aaaa	Voice Reserve 10	0 - 64
00	3A-00	43	0aaa aaaa	Reserve	--
Total size		00 00 00 44			

*1: SHORT, LONG

*2: EFX, REVERB, EFX+REV

*3: ROOM1, ROOM2, STAGE1, STAGE2, HALL1, HALL2

*4: 200, 250, 315, 400, 500, 630, 800, 1000, 1250, 1600, 2000, 2500, 3150, 4000, 5000, 6300, 8000, BYPASS

EFX Parameter	value	disp
Type 0: 4-BAND-EQ		
prm1	Low Freq	0 - 1 200,400
prm2	Low Gain	0 - 30 -15 - +15
prm3	High Freq	0 - 1 4000,8000
prm4	High Gain	0 - 30 -15 - +15
prm5	Peak1 Freq	0 - 16 (freq)
prm6	Peak1 Q	0 - 4 0.5,1.0,2.0,4.0,8.0
prm7	Peak1 Gain	0 - 30 -15 - +15
prm8	Peak2 Freq	0 - 16 (freq)
prm9	Peak2 Q	0 - 4 0.5,1.0,2.0,4.0,8.0
prm10	Peak2 Gain	0 - 30 -15 - +15
prm11	Output Level	0 - 127
Type 1: SPECTRUM		
prm1	Low-High	0 - 30 -15 - +15
prm2	Middle Gain	0 - 30 -15 - +15
prm3	Width	0 - 4 1 - 5
prm4	Output Pan	0 - 127 L64 - R63
prm5	Output Level	0 - 127
Type 2: ENHANCER		
prm1	Sens	0 - 127
prm2	Mix	0 - 127
prm3	Low Gain	0 - 30 -15 - +15
prm4	High Gain	0 - 30 -15 - +15
prm5	Output Level	0 - 127
Type 3: OVERDRIVE		
prm1	Input Level	0 - 127
prm2	Drive	0 - 127
prm3	AMP Type	0 - 3 SMALL, BUILTIN, 2STACK, 3STACK
prm4	Output Pan	0 - 127 L64 - R63
prm5	Output Level	0 - 127
Type 4: DISTORTION		
prm1	Input Level	0 - 127
prm2	Drive	0 - 127
prm3	AMP Type	0 - 3 SMALL, BUILTIN, 2STACK, 3STACK
prm4	Output Pan	0 - 127 L64 - R63
prm5	Output Level	0 - 127
Type 5: Lo-Fi		
prm1	BitDown	0 - 7
prm2	S-Rate Down	0 - 3 32,16,8,4
prm3	Post Gain	0 - 3 0, +6, +12, +18
prm4	Low Gain	0 - 30 -15 - +15
prm5	High Gain	0 - 30 -15 - +15
prm6	Output	0 - 1 Mono, Stereo
prm7	Output Level	0 - 127
Type 6: NOISE		
prm1	Noise Type	0 - 17 1 - 18
prm2	Noise Level	0 - 127

prm3	N Filter	0 - 17	(freq),BYPASS
prm4	Lo-Fi Level	0 - 127	
prm5	Output Pan	0 - 127	L64 - R63
prm6	Output Level	0 - 127	
Type 7: RADIO-TUNG			
prm1	Radio Detune	0 - 127	
prm2	Noise Level	0 - 127	
prm3	Low Gain	0 - 30	-15 - +15
prm4	High Gain	0 - 30	-15 - +15
prm5	Output	0 - 1	Mono,Stereo
prm6	Output Level	0 - 127	
Type 8: PHONOGRAPH			
prm1	Disc Type	0 - 2	LP,EP,SP
prm2	D Noise Lvl	0 - 127	
prm3	Depth	0 - 20	0 - +20
prm4	Output Pan	0 - 127	L64 - R63
prm5	Output Level	0 - 127	
Type 9: COMPRESSOR			
prm1	Attack	0 - 127	
prm2	Sustain	0 - 127	
prm3	Post Gain	0 - 3	0,+6,+12,+18
prm4	Low Gain	0 - 30	-15 - +15
prm5	High Gain	0 - 30	-15 - +15
prm6	Output Level	0 - 127	
Type 10: LIMITER			
prm1	Threshold	0 - 127	
prm2	Ratio	0 - 3	1.5:1,2.0:1,4.0:1,100:1
prm3	Release	0 - 127	
prm4	Post Gain	0 - 3	0,+6,+12,+18
prm5	Output Pan	0 - 127	L64 - R63
prm6	Output Level	0 - 127	
Type 11: SLICER			
prm1	Timing	0 - 33	(pattern)
prm2	Rate	0 - 2	1/4,1/2,1/1
prm3	Accent Pattern	0 - 15	(pattern)
prm4	Accent Level	0 - 127	
prm5	Attack	0 - 9	1 - 10
prm6	Output Level	0 - 127	
Type 12: TREMOLO			
prm1	LFO Type	0 - 5	TRI,TRP,SIN,SAW1,SAW2,SQR
prm2	Rate	0 - 117	0.05 - 10.00,(rate)
prm3	Depth	0 - 127	
prm4	Low Gain	0 - 30	-15 - +15
prm5	High Gain	0 - 30	-15 - +15
prm6	Output Level	0 - 127	
Type 13: PHASER			
prm1	Manual	0 - 125	100 - 8000
prm2	Rate	0 - 117	0.05 - 10.00,(rate)
prm3	Depth	0 - 127	
prm4	Resonance	0 - 127	
prm5	Mix	0 - 127	
prm6	Output Pan	0 - 127	L64 - R63
prm7	Output Level	0 - 127	
Type 14: CHORUS			
prm1	Pre Delay	0 - 125	0.0 - 100
prm2	Rate	0 - 117	0.05 - 10.00,(rate)
prm3	Depth	0 - 127	
prm4	Phase	0 - 90	0 - 180
prm5	Filter Type	0 - 2	OFF,LPF,HPF
prm6	Cutoff	0 - 16	(freq)
prm7	Balance	0 - 100	D100:0E - D0:100E
prm8	Output Level	0 - 127	
Type 15: SPACE-D			
prm1	Pre Delay	0 - 125	0.0 - 100
prm2	Rate	0 - 117	0.05 - 10.00,(rate)
prm3	Depth	0 - 127	
prm4	Phase	0 - 90	0 - 180
prm5	Low Gain	0 - 30	-15 - +15
prm6	High Gain	0 - 30	-15 - +15
prm7	Balance	0 - 100	D100:0E - D0:100E
prm8	Output Level	0 - 127	
Type 16: TETRA-CHORUS			
prm1	Pre Delay	0 - 125	0.0 - 100
prm2	Rate	0 - 117	0.05 - 10.00,(rate)
prm3	Depth	0 - 127	
prm4	Pre Dly Devi	0 - 20	
prm5	Depth Devi	0 - 40	-20 - +20
prm6	Pan Devi	0 - 20	
prm7	Balance	0 - 100	D100:0E - D0:100E
prm8	Output Level	0 - 127	
Type 17: FLANGER			
prm1	Pre Delay	0 - 125	0.0 - 100
prm2	Rate	0 - 117	0.05 - 10.00,(rate)
prm3	Depth	0 - 127	
prm4	Feedback	0 - 98	0 - +98
prm5	Phase	0 - 90	0 - 180
prm6	Filter Type	0 - 2	OFF,LPF,HPF
prm7	Cutoff	0 - 16	(freq)
prm8	Balance	0 - 100	D100:0E - D0:100E
prm9	Output Level	0 - 127	
Type 18: ST-FLANGER			
prm1	Pre Delay	0 - 125	0.0 - 100
prm2	Rate	0 - 117	0.05 - 10.00,(rate)
prm3	Depth	0 - 127	
prm4	Feedback	0 - 98	0 - +98
prm5	Step Rate	0 - 125	0.05 - 10.00,(rate)
prm6	Phase	0 - 90	0 - 180
prm7	Balance	0 - 100	D100:0E - D0:100E
prm8	Output Level	0 - 127	
Type 19: SHORT-DELAY			
prm1	Time L	0 - 103	0.1 - 190
prm2	Time R	0 - 103	0.1 - 190
prm3	HF Damp	0 - 17	(freq),BYPASS
prm4	Feedback	0 - 98	0 - +98
prm5	Auto Pan	0 - 18	(rate)

prm6	Low Gain	0 - 30	-15 - +15
prm7	High Gain	0 - 30	-15 - +15
prm8	Balance	0 - 100	D100:0E - D0:100E
prm9	Output Level	0 - 127	
Type 20: AUTO-PAN			
prm1	LFO type	0 - 5	TRI,TRP,SIN,SAW1,SAW2,SQR
prm2	Rate	0 - 117	0.05 - 10.00,(rate)
prm3	Bass Sense	0 - 2	OFF,MODE1,MODE2
prm4	Depth	0 - 127	
prm5	Low Gain	0 - 30	-15 - +15
prm6	High Gain	0 - 30	-15 - +15
prm7	Output Level	0 - 127	
Type 21: FB-P-SHIFT			
prm1	Coarse	0 - 36	-24 - +12
prm2	Fine	0 - 100	-100 - +100
prm3	Output Pan	0 - 127	
prm4	Pre Delay	0 - 125	0.0 - 100
prm5	Mode	0 - 4	1 - 5
prm6	Feedback	0 - 98	0 - +98
prm7	Low Gain	0 - 30	-15 - +15
prm8	High Gain	0 - 30	-15 - +15
prm9	Balance	0 - 100	D100:0E - D0:100E
prm10	Output Level	0 - 127	
Type 22: REVERB			
prm1	Rev Type	0 - 5	ROOM1,ROOM2,STAGE1,STAGE2, HALL1,HALL2
prm2	Time	0 - 127	
prm3	HF Damp	0 - 17	(freq),BYPASS
prm4	Balance	0 - 100	D100:0E - D0:100E
prm5	Output Level	0 - 127	
Type 23: GATE-REVERB			
prm1	Gate Type	0 - 3	NORMAL,REVERSE,SWEEP1,SWEEP2
prm2	Gate Time	0 - 65	5 - 330
prm3	Balance	0 - 100	D100:0E - D0:100E
prm4	Output Level	0 - 127	

1-2.2.Part Info Part

Offset	Address	Size	Description	Data (Value)
	00 00	0000 000a	Receive Switch	0 - 1 (OFF,ON)
	00 01	0aaa aaaa	Reserve	--
#	00 02	0000 00aa	Patch Group Type	0 - 2 *1
	00 03	0aaa aaaa	Patch Group ID	0 - 127
	00 04	0000 aaaa	Patch Number	0 - 254
		0000 bbbb		(001 - 255)
	00 06	0aaa aaaa	Part Level	0 - 127
	00 07	0aaa aaaa	Part Pan	0 - 127 (L64 - 63R)
	00 08	0aaa aaaa	Part Coarse Tune	0 - 96 (-48 - +48)
	00 09	0aaa aaaa	Part Fine Tune	0 - 100 (-50 - +50)
	00 0A	0000 0aaa	EFX/Output Assign	0 - 4 *2
	00 0B	0aaa aaaa	Mix/EFX Send Level	0 - 127
	00 0C	0aaa aaaa	Delay Send Level	0 - 127
	00 0D	0aaa aaaa	Reverb Send Level	0 - 127
00 0E	0000 000a	Receive Program Change Switch	0 - 1 (OFF,ON)	
00 0F	0000 000a	Receive Volume Switch	0 - 1 (OFF,ON)	
00 10	0000 000a	Receive Hold-1 Switch	0 - 1 (OFF,ON)	
00 11	0aaa aaaa	Keyboard Range Lower	0 - 127 *3	
00 12	0aaa aaaa	Keyboard Range Upper	0 - 127 *4	
	00 13	0000 0aaa	Octave Shift	0 - 6 (<-3 - +3>)
	00 14	0000 000a	Local Switch	0 - 1 (<OFF,ON>)
	00 15	0000 000a	Transmit Switch	0 - 1 (<OFF,ON>)
	00 16-00 19	0aaa aaaa	Reserve	--
Total size		00 00 00 1A		

*1: Reserve, PRESET, USER&CARD

*2: DRY, EFX, DIR1, DIR2, RHY

*3: C-1-Upper

*4: Lower-G9

1-3.Patch

Offset	Address	Description	Data (Value)
	00 00	Patch Common	1-3-1
	10 00	Patch Tone 1	1-3-2
	12 00	Patch Tone 2	
	14 00	Patch Tone 3	
	16 00	Patch Tone 4	

1-3-1.Patch Common

Offset	Address	Size	Description	Data (Value)
	00 00	0aaa aaaa	Patch Name 1	32 - 125
	00 01	0aaa aaaa	Patch Name 2	32 - 125
	00 02	0aaa aaaa	Patch Name 3	32 - 125
	00 03	0aaa aaaa	Patch Name 4	32 - 125
	00 04	0aaa aaaa	Patch Name 5	32 - 125
	00 05	0aaa aaaa	Patch Name 6	32 - 125
	00 06	0aaa aaaa	Patch Name 7	32 - 125
	00 07	0aaa aaaa	Patch Name 8	32 - 125
	00 08	0aaa aaaa	Patch Name 9	32 - 125
	00 09	0aaa aaaa	Patch Name 10	32 - 125
	00 0A	0aaa aaaa	Patch Name 11	32 - 125
	00 0B	0aaa aaaa	Patch Name 12	32 - 125
	00 0C-00 2B	0aaa aaaa	Reserve	--

#	00 2C	0000 aaaa	Patch Tempo	20 - 250
		0000 bbbb		
	00 2E	0aaa aaaa	Patch Level	0 - 127
	00 2F	0aaa aaaa	Patch Pan	0 - 127 (L64 - 63R)
	00 30	0aaa aaaa	Analog Feel	0 - 127
	00 31	0000 aaaa	Bend Range Up	0 - 12
	00 32	00aa aaaa	Bend Range Down	0 - 48 (0 - -48)
	00 33	0000 000a	Key Assign Mode	0 - 1 (POLY,SOLO)
	00 34	0000 000a	Solo Legato	0 - 1 (OFF,ON)
	00 35	0000 000a	Portamento Switch	0 - 1 (OFF,ON)
	00 36	0000 000a	Portamento Mode	0 - 1 *1
	00 37	0000 000a	Portamento Type	0 - 1 (RATE,TIME)
	00 38	0000 000a	Portamento Start	0 - 1 (PITCH,NOTE)
	00 39	0aaa aaaa	Portamento Time	0 - 127
	00 3A	0000 aaaa	Patch Control Source 2	0 - 15 *2
	00 3B	0000 aaaa	Patch Control Source 3	0 - 15 *2
	00 3C	0000 00aa	EFX Control Hold/Peak	0 - 2 *3
	00 3D	0000 00aa	Control 1 Hold/Peak	0 - 2 *3
	00 3E	0000 00aa	Control 2 Hold/Peak	0 - 2 *3
	00 3F	0000 00aa	Control 3 Hold/Peak	0 - 2 *3
	00 40	0000 000a	Velocity Range Switch	0 - 1 (OFF,ON)
	00 41	0000 0aaa	Octave Shift	0 - 6 (-3 - +3)
	00 42	0000 00aa	Stretch Tune Depth	0 - 3 (OFF,1 - 3)
	00 43	0000 000a	Voice Priority	0 - 1 *4
	00 44	0000 aaaa	Structure Type 1&2	0 - 9 (1 - 10)
	00 45	0000 00aa	Booster 1&2	0 - 3 *5
	00 46	0000 aaaa	Structure Type 3&4	0 - 9 (1 - 10)
	00 47	0000 00aa	Booster 3&4	0 - 3 *5
	00 48	0000 000a	Clock Source	0 - 1 *6
	00 49	0aaa aaaa	Reserve	--
Total size		00 00 00 4A		

*1: NORMAL, LEGATO

*2: OFF, SYS-CTRL1, SYS-CTRL2, MODULATION, BREATH, FOOT, VOLUME, PAN, EXPRESSION, PITCH BEND, AFTERTOUCH, LFO1, LFO2, VELOCITY, KEYFOLLOW, PLAYMATE

*3: OFF, HOLD, PEAK

*4: LAST, LOUDEST

*5: 0, +6, +12, +18

*6: PATCH, SYSTEM

1-3-2.Patch Tone

Offset	Address	Size	Description	Data (Value)
	00 00	0000 000a	Tone Switch	0 - 1 (OFF,ON)
	00 01	0aaa aaaa	Reserve	--
#	00 02	0aaa aaaa	Wave Group ID	0 - 127
	00 03	0000 aaaa	Wave Number	0 - 254
		0000 bbbb		(001 - 255)
	00 05	0000 00aa	Wave Gain	0 - 3 *1
	00 06	0000 000a	FXM Switch	0 - 1 (OFF,ON)
	00 07	0000 00aa	FXM Color	0 - 3 (1 - 4)
	00 08	0000 aaaa	FXM Depth	0 - 15 (1 - 16)
	00 09-00 0A	0aaa aaaa	Reserve	--
	00 0B	0aaa aaaa	Velocity Cross Fade	0 - 127
	00 0C	0aaa aaaa	Velocity Range Lower	1 - 127 *2
	00 0D	0aaa aaaa	Velocity Range Upper	1 - 127 *3
	00 0E	0aaa aaaa	Keyboard Range Lower	0 - 127 *4
	00 0F	0aaa aaaa	Keyboard Range Upper	0 - 127 *5
	00 10-00 14	0aaa aaaa	Reserve	--
	00 15	000a aaaa	Modulation Destination 1	0 - 15 *6
	00 16	0aaa aaaa	Modulation Depth 1	0 - 126 (-63 - +63)
	00 17	000a aaaa	Modulation Destination 2	0 - 15 *6
	00 18	0aaa aaaa	Modulation Depth 2	0 - 126 (-63 - +63)
	00 19	000a aaaa	Modulation Destination 3	0 - 15 *6
	00 1A	0aaa aaaa	Modulation Depth 3	0 - 126 (-63 - +63)
	00 1B	0aaa aaaa	Modulation Destination 4	0 - 15 *6
	00 1C	0aaa aaaa	Modulation Depth 4	0 - 126 (-63 - +63)
	00 1D	000a aaaa	Pitch Bend Destination 1	0 - 15 *6
	00 1E	0aaa aaaa	Pitch Bend Depth 1	0 - 126 (-63 - +63)
	00 1F	000a aaaa	Pitch Bend Destination 2	0 - 15 *6
	00 20	0aaa aaaa	Pitch Bend Depth 2	0 - 126 (-63 - +63)
	00 21	000a aaaa	Pitch Bend Destination 3	0 - 15 *6
	00 22	0aaa aaaa	Pitch Bend Depth 3	0 - 126 (-63 - +63)
	00 23	000a aaaa	Pitch Bend Destination 4	0 - 15 *6
	00 24	0aaa aaaa	Pitch Bend Depth 4	0 - 126 (-63 - +63)
	00 25	000a aaaa	After Touch Destination 1	0 - 15 *6
	00 26	0aaa aaaa	After Touch Depth 1	0 - 126 (-63 - +63)
	00 27	000a aaaa	After Touch Destination 2	0 - 15 *6
	00 28	0aaa aaaa	After Touch Depth 2	0 - 126 (-63 - +63)
	00 29	000a aaaa	After Touch Destination 3	0 - 15 *6
	00 2A	0aaa aaaa	After Touch Depth 3	0 - 126 (-63 - +63)
	00 2B	000a aaaa	After Touch Destination 4	0 - 15 *6
	00 2C	0aaa aaaa	After Touch Depth 4	0 - 126 (-63 - +63)
	00 2D	0000 0aaa	LFO1 Waveform	0 - 7 *7
	00 2E	0000 000a	LFO1 Key Trigger	0 - 1 (OFF,ON)
	00 2F	0aaa aaaa	LFO1 Rate	0 - 127
	00 30	0000 0aaa	LFO1 Offset	0 - 4 *8
	00 31	0aaa aaaa	LFO1 Delay Time	0 - 127
	00 32	0000 00aa	LFO1 Fade Mode	0 - 3 *9
	00 33	0aaa aaaa	LFO1 Fade Time	0 - 127
	00 34	0000 00aa	LFO1 External Sync	0 - 2 *10
	00 35	0000 0aaa	LFO2 Waveform	0 - 7 *7
	00 36	0000 000a	LFO2 Key Trigger	0 - 1 (OFF,ON)
	00 37	0aaa aaaa	LFO2 Rate	0 - 127
	00 38	0000 0aaa	LFO2 Offset	0 - 4 *8
	00 39	0aaa aaaa	LFO2 Delay Time	0 - 127
	00 3A	0000 00aa	LFO2 Fade Mode	0 - 3 *9
	00 3B	0aaa aaaa	LFO2 Fade Time	0 - 127
	00 3C	0000 00aa	LFO2 External Sync	0 - 2 *10
	00 3D	0aaa aaaa	Coarse Tune	0 - 96 (-48 - +48)
	00 3E	0aaa aaaa	Fine Tune	0 - 100 (-50 - +50)
	00 3F	000a aaaa	Random Pitch Depth	0 - 30 *11
	00 40	0000 aaaa	Pitch Keyfollow	0 - 15 *12
	00 41	000a aaaa	Pitch Envelope Depth	0 - 24 (-12 - +12)
	00 42	0aaa aaaa	Pitch Envelope Velocity Sens	0 - 125 *13

00 43	0000 aaaa	Pitch Envelope Velocity Time1	0 - 14	*14
00 44	0000 aaaa	Pitch Envelope Velocity Time4	0 - 14	*14
00 45	0000 aaaa	Pitch Envelope Time Keyfollow	0 - 14	*14
00 46	0aaa aaaa	Pitch Envelope Time 1	0 - 127	
00 47	0aaa aaaa	Pitch Envelope Time 2	0 - 127	
00 48	0aaa aaaa	Pitch Envelope Time 3	0 - 127	
00 49	0aaa aaaa	Pitch Envelope Time 4	0 - 127	
00 4A	0aaa aaaa	Pitch Envelope Level 1	0 - 126	(-63 - +63)
00 4B	0aaa aaaa	Pitch Envelope Level 2	0 - 126	(-63 - +63)
00 4C	0aaa aaaa	Pitch Envelope Level 3	0 - 126	(-63 - +63)
00 4D	0aaa aaaa	Pitch Envelope Level 4	0 - 126	(-63 - +63)
00 4E	0aaa aaaa	Pitch LFO1 Depth	0 - 126	(-63 - +63)
00 4F	0aaa aaaa	Pitch LFO2 Depth	0 - 126	(-63 - +63)
+				
00 50	0000 0aaa	Filter Type	0 - 4	*15
00 51	0aaa aaaa	Cutoff Frequency	0 - 127	
00 52	0000 aaaa	Cutoff Keyfollow	0 - 15	*12
00 53	0aaa aaaa	Resonance	0 - 127	
00 54	0aaa aaaa	Resonance Velocity Sens	0 - 125	*13
00 55	0aaa aaaa	Filter Envelope Depth	0 - 126	(-63 - +63)
00 56	0000 0aaa	Filter Envelope Velocity Curve	0 - 6	(1 - 7)
00 57	0aaa aaaa	Filter Envelope Velocity Sens	0 - 125	*13
00 58	0000 aaaa	Filter Envelope Velocity Time1	0 - 14	*14
00 59	0000 aaaa	Filter Envelope Velocity Time4	0 - 14	*14
00 5A	0000 aaaa	Filter Envelope Time Keyfollow	0 - 14	*14
00 5B	0aaa aaaa	Filter Envelope Time 1	0 - 127	
00 5C	0aaa aaaa	Filter Envelope Time 2	0 - 127	
00 5D	0aaa aaaa	Filter Envelope Time 3	0 - 127	
00 5E	0aaa aaaa	Filter Envelope Time 4	0 - 127	
00 5F	0aaa aaaa	Filter Envelope Level 1	0 - 127	
00 60	0aaa aaaa	Filter Envelope Level 2	0 - 127	
00 61	0aaa aaaa	Filter Envelope Level 3	0 - 127	
00 62	0aaa aaaa	Filter Envelope Level 4	0 - 127	
00 63	0aaa aaaa	Filter LFO1 Depth	0 - 126	(-63 - +63)
00 64	0aaa aaaa	Filter LFO2 Depth	0 - 126	(-63 - +63)
+				
00 65	0aaa aaaa	Tone Level	0 - 127	
00 66	0000 00aa	Bias Direction	0 - 3	*16
00 67	0aaa aaaa	Bias Position	0 - 127	(C-1 - G9)
00 68	0000 aaaa	Bias Level	0 - 14	*14
00 69	0000 0aaa	Level Envelope Velocity Curve	0 - 6	(1 - 7)
00 6A	0aaa aaaa	Level Envelope Velocity Sens	0 - 125	*13
00 6B	0000 aaaa	Level Envelope Velocity Time1	0 - 14	*14
00 6C	0000 aaaa	Level Envelope Velocity Time4	0 - 14	*14
00 6D	0000 aaaa	Level Envelope Time Keyfollow	0 - 14	*14
00 6E	0aaa aaaa	Level Envelope Time 1	0 - 127	
00 6F	0aaa aaaa	Level Envelope Time 2	0 - 127	
00 70	0aaa aaaa	Level Envelope Time 3	0 - 127	
00 71	0aaa aaaa	Level Envelope Time 4	0 - 127	
00 72	0aaa aaaa	Level Envelope Level 1	0 - 127	
00 73	0aaa aaaa	Level Envelope Level 2	0 - 127	
00 74	0aaa aaaa	Level Envelope Level 3	0 - 127	
00 75	0aaa aaaa	Level LFO1 Depth	0 - 126	(-63 - +63)
00 76	0aaa aaaa	Level LFO2 Depth	0 - 126	(-63 - +63)
00 77	0aaa aaaa	Tone Pan	0 - 127	(L64 - 63R)
00 78	0000 aaaa	Pan Keyfollow	0 - 14	*14
00 79	00aa aaaa	Random Pan Depth	0 - 63	
00 7A	0aaa aaaa	Alternate Pan Depth	1 - 127	(L63 - 63R)
00 7B	0aaa aaaa	Pan LFO1 Depth	0 - 126	(L63 - 63R)
00 7C	0aaa aaaa	Pan LFO2 Depth	0 - 126	(L63 - 63R)
00 7D-01 00	0aaa aaaa	Reserve	--	
+				
Total size	00 00 01 01			

*1: -6, 0, +6, +12

*2: 1-Upper

*3: Lower-127

*4: C-1-Upper

*5: Lower-G9

*6: OFF, PCH, CUT, RES, LEV, PAN, L1P, L2P, L1F, L2F, L1A, L2A, L1p, L2p, L1R, L2R

*7: TRI, SIN, SAW, SQR, TRP, S&H, RND, CHS

*8: -100, -50, 0, +50, +100

*9: ON-IN, ON-OUT, OFF-IN, OFF-OUT

*10: OFF, CLOCK

*11: 0, 1, 2, 3, 4, 5, 6, 7, 8, 9, 10, 20, 30, 40, 50, 60, 70, 80,

*12: -100, -70, -50, -30, -10, 0, +10, +20, +30, +40, +50, +70, +100, +120, +150, +200

*13: -100+150

*14: -100, -70, -50, -40, -30, -20, -10, 0, +10, +20, +30, +40, +50, +70, +100

*15: OFF, LPF, BPF, HPF, PKG

*16: LOWER, UPPER, LOW&UP, ALL

■ 1-4.Rhythm Setup

Offset	Address	Description	
00 00		Rhythm Common	1-4-1
23 00		Rhythm Note for Key# 35	1-4-2
24 00		Rhythm Note for Key# 36	
:			
62 00		Rhythm Note for Key# 98	

■ 1-4-1.Rhythm Common

Offset Address	Size	Description	Data (Value)
00 00	0aaa aaaa	Rhythm Name 1	32 - 125
00 01	0aaa aaaa	Rhythm Name 2	32 - 125
00 02	0aaa aaaa	Rhythm Name 3	32 - 125
00 03	0aaa aaaa	Rhythm Name 4	32 - 125
00 04	0aaa aaaa	Rhythm Name 5	32 - 125
00 05	0aaa aaaa	Rhythm Name 6	32 - 125
00 06	0aaa aaaa	Rhythm Name 7	32 - 125
00 07	0aaa aaaa	Rhythm Name 8	32 - 125
00 08	0aaa aaaa	Rhythm Name 9	32 - 125
00 09	0aaa aaaa	Rhythm Name 10	32 - 125
00 0A	0aaa aaaa	Rhythm Name 11	32 - 125
00 0B	0aaa aaaa	Rhythm Name 12	32 - 125
Total size	00 00 00 0C		

■ 1-4-2.Rhythm Note

Offset Address	Size	Description	Data (Value)
00 00	0000 000a	Tone Switch	0 - 1 (OFF,ON)
00 01	0000 00aa	Wave Group Type	0 - 2 *1
00 02	0aaa aaaa	Wave Group ID	0 - 127
# 00 03	0000 aaaa	Wave Number	0 - 254
	0000 bbbb		(001 - 255)
00 05	0000 00aa	Wave Gain	0 - 3 *2
00 06	0000 aaaa	Bend Range	0 - 12
00 07	000a aaaa	Mute Group	0 - 31 (OFF, 1 - 31)
00 08	0000 000a	Envelope Mode	0 - 1 *3
00 09	0000 000a	Volume Control Switch	0 - 1 (OFF,ON)
00 0A	0000 000a	Hold-1 Control Switch	0 - 1 (OFF,ON)
00 0B	0000 00aa	Pan Control Switch	0 - 2 *4
00 0C	0aaa aaaa	Source Key	0 - 127 (C-1 - G9)
00 0D	0aaa aaaa	Fine Tune	0 - 100 (-50 - +50)
00 0E	000a aaaa	Random Pitch Depth	0 - 30 *5
00 0F	000a aaaa	Pitch Envelope Depth	0 - 24 (-12 - +12)
00 10	0aaa aaaa	Pitch Envelope Velocity Sens	0 - 125 *6
00 11	0000 aaaa	Pitch Envelope Velocity Time	0 - 14 *7
00 12	0aaa aaaa	Pitch Envelope Time 1	0 - 127
00 13	0aaa aaaa	Pitch Envelope Time 2	0 - 127
00 14	0aaa aaaa	Pitch Envelope Time 3	0 - 127
00 15	0aaa aaaa	Pitch Envelope Time 4	0 - 127
00 16	0aaa aaaa	Pitch Envelope Level 1	0 - 126 (-63 - +63)
00 17	0aaa aaaa	Pitch Envelope Level 2	0 - 126 (-63 - +63)
00 18	0aaa aaaa	Pitch Envelope Level 3	0 - 126 (-63 - +63)
00 19	0aaa aaaa	Pitch Envelope Level 4	0 - 126 (-63 - +63)
00 1A	0000 0aaa	Filter Type	0 - 4 *8
00 1B	0aaa aaaa	Cutoff Frequency	0 - 127
00 1C	0aaa aaaa	Resonance	0 - 127
00 1D	0aaa aaaa	Resonance Velocity Sens	0 - 125 *6
00 1E	0aaa aaaa	Filter Envelope Depth	0 - 126 (-63 - +63)
00 1F	0aaa aaaa	Filter Envelope Velocity Sens	0 - 125 *6
00 20	0000 aaaa	Filter Envelope Velocity Time	0 - 14 *7
00 21	0aaa aaaa	Filter Envelope Time 1	0 - 127
00 22	0aaa aaaa	Filter Envelope Time 2	0 - 127
00 23	0aaa aaaa	Filter Envelope Time 3	0 - 127
00 24	0aaa aaaa	Filter Envelope Time 4	0 - 127
00 25	0aaa aaaa	Filter Envelope Level 1	0 - 127
00 26	0aaa aaaa	Filter Envelope Level 2	0 - 127
00 27	0aaa aaaa	Filter Envelope Level 3	0 - 127
00 28	0aaa aaaa	Filter Envelope Level 4	0 - 127
00 29	0aaa aaaa	Tone Level	0 - 127
00 2A	0aaa aaaa	Level Envelope Velocity Sens	0 - 125 *6
00 2B	0000 aaaa	Level Envelope Velocity Time	0 - 14 *7
00 2C	0aaa aaaa	Level Envelope Time 1	0 - 127
00 2D	0aaa aaaa	Level Envelope Time 2	0 - 127
00 2E	0aaa aaaa	Level Envelope Time 3	0 - 127
00 2F	0aaa aaaa	Level Envelope Time 4	0 - 127
00 30	0aaa aaaa	Level Envelope Level 1	0 - 127
00 31	0aaa aaaa	Level Envelope Level 2	0 - 127
00 32	0aaa aaaa	Level Envelope Level 3	0 - 127
00 33	0aaa aaaa	Tone Pan	0 - 127 (L64 - 63R)
00 34	00aa aaaa	Random Pan Depth	0 - 63
00 35	0aaa aaaa	Alternate Pan Depth	1 - 127 (L63 - 63R)
00 36	0000 00aa	Output Assign	0 - 3 *9
00 37	0aaa aaaa	EFX Send Level	0 - 127
00 38	0aaa aaaa	Delay Send Level	0 - 127
00 39	0aaa aaaa	Reverb Send Level	0 - 127
Total size	00 00 00 3A		

*1: INT, <PCM>, EXP

*2: -6, 0, +6, +12

*3: NO-SUS, SUSTAIN

*4: OFF, CONTINUOUS, KEY-ON

*5: 0, 1, 2, 3, 4, 5, 6, 7, 8, 9, 10, 20, 30, 40, 50, 60, 70, 80, 90, 100, 200, 300, 400, 500, 600, 700, 800, 900, 1000, 1100, 1200

*6: -100~+150

*7: -100, -70, -50, -40, -30, -20, -10, 0, +10, +20, +30, +40, +50, +70, +100

*8: OFF, LPF, BPF, HPF, PKG

*9: MIX, EFX, DIR1, DIR2

■ 1-5. Sequencer Temporary Pattern Setup

Offset Address	Size	Description	Data (Value)
00 00 :	0aaa aaaa :	Temporary Pattern Setup :	0 - 127
Total size		0F 7F 7F 7F	

■ 1-6. Sequencer Temporary Pattern Body

Offset Address	Size	Description	Data (Value)
00 00 :	0aaa aaaa :	Temporary Pattern Body :	0 - 127
Total size		7F 7F 7F 7F	

■ 2. GS (Model ID=42H)

Start address	Description	
40 10 00	Scale Tune PartR	2-1
40 11 00	: Part1	
40 12 00	: Part2	
40 13 00	: Part3	
40 14 00	: Part4	
40 15 00	: Part5	
40 16 00	: Part6	
40 17 00	: Part7	

■ 2-1. Scale Tune

Offset Address	Size	Description	Data (Value)
40	0aaa aaaa	Scale Tune for C	0 - 127 (-64 - +63)
41	0aaa aaaa	Scale Tune for C#	0 - 127 (-64 - +63)
42	0aaa aaaa	Scale Tune for D	0 - 127 (-64 - +63)
43	0aaa aaaa	Scale Tune for Eb	0 - 127 (-64 - +63)
44	0aaa aaaa	Scale Tune for E	0 - 127 (-64 - +63)
45	0aaa aaaa	Scale Tune for F	0 - 127 (-64 - +63)
46	0aaa aaaa	Scale Tune for F#	0 - 127 (-64 - +63)
47	0aaa aaaa	Scale Tune for G	0 - 127 (-64 - +63)
48	0aaa aaaa	Scale Tune for G#	0 - 127 (-64 - +63)
49	0aaa aaaa	Scale Tune for A	0 - 127 (-64 - +63)
4A	0aaa aaaa	Scale Tune for A#	0 - 127 (-64 - +63)
4B	0aaa aaaa	Scale Tune for B	0 - 127 (-64 - +63)

Note) In order for GS exclusive messages to be received correctly by the MC-505, the starting address of the message must be the starting address of each part (the address of Scale Tune C; i.e., offset 40).

■ 3. Quick SysEx (Model ID=3AH)

Start address	Description	
30 00	Quick SysEx Part1	2-1
31 00	: Part2	
:	:	
36 00	: Part7	
39 00	: PartR	
70 00	: Sequencer	

■ 3-1. Quick SysEx Part

Offset Address	Size DataL	DataE*5	Description	Data (Value L)
0F	0000 aaaa	0000 0000	LF01 Wave Form	0 - 7 *1
15	0aaa aaaa	0000 aaaa	Coarse Tune	0 - 120 *2
19	0aaa aaaa	0000 aaaa	Pitch Env Depth	0 - 127 (-63 - +63)
1A	0aaa aaaa	0000 aaaa	Pitch Env Attack	0 - 127
1B	0aaa aaaa	0000 aaaa	Pitch Env Decay	0 - 127
1C	0aaa aaaa	0000 aaaa	Filter Env Sustain	0 - 127
1D	0aaa aaaa	0000 aaaa	Filter Env Release	0 - 127
1F	0aaa aaaa	0000 aaaa	Amplitude Env Sustain	0 - 127
22	0000 0aaa	0000 aaaa	Filter Type	0 - 4 *3
23	0aaa aaaa	0000 aaaa	Tone Pan	0 - 127 (-63 - +63)
24	0aaa aaaa	0000 aaaa	Tone Level	0 - 127
25	0aaa aaaa	0000 aaaa	Random Pan Depth	0 - 127 (-63 - +63)
27	0aaa aaaa	0000 aaaa	Pitch Env Sustain	0 - 127
28	0aaa aaaa	0000 aaaa	Pitch Env Release	0 - 127
55	0aaa aaaa	0000 0000	Part Key Shift	16 - 112 (-48 - +48)
56	0000 00aa	0000 0000	Part EFX/Output Assign	0 - 4 *4

*1: TRI, SIN, SAW, SQR, TRP, S&H, RND, CHS

*2: Normal Part 16-112 (-48-+48), Rhythm Part 0-120

*3: Pass, LPF, HPF, BPF, PKG

*4: DRY, EFX, DIR1, DIR2, RHY

*5: Normal Part=0, Rhythm Part (BD=0, SD=1, HH=2, CLP=3, CYM=4, TOM/PERC=5, HIT=6, OTHERS=7, ALL=9)

Note) In order for quick exclusive messages to be received correctly by the MC-505, the starting address of the message must be the starting address of each part.

3-2. Quick SysEx Sequencer

Offset Address	Size DataL	DataE	Description	Data(Value L/E)
01	0000	aaaa 0000 000a	Part Mute	0-6,9 / 0,1
02	0000	aaaa 0000 000a	Drum Mute	0-7*1 / 0,1
03	0aaa	aaaa 0aaa aaaa	Tempo	3-93 / 0-128

*1: BD, SD, HH, CLP, CYM, TOM/PEC, HIT, OTHERS

Address block map

The following is an outline of the address map for Exclusive messages

Address(H)	Block	Sub Block	Reference
00 00 00 00	System common		1-1-1
	Scale tune	Part 1	1-1-2
		:	
		Part 16	
		:	
		Patch	
01 00 00 00	Part Info	Common	1-2-1
	Part	Part 1	1-2-2
		:	
		Part Rhy	
02 00 00 00	temporary patch	Part 1	Common 1-3-1
		:	Tone 1 1-3-2
		Part 9	:
		:	Tone 4
02 09 00 00	Temporary Rhythm Setup	Common	1-4-1
		Note# 35	1-4-2
		:	
		Note# 98	
30 00 00 00	Temporary Pattern Setup Sequencer		1-5-1
:	:		
:	:		
:	:		
40 00 00 00	Temporary Pattern Body		1-6-1
:	:		
:	:		
:	:		

4. Supplementary material

■ Decimal/Hexadecimal table

MIDI uses 7-bit hexadecimal values to indicate data values and the address and size of exclusive messages. The following table shows the correspondence between decimal and hexadecimal numbers.

* Hexadecimal values are indicated by a following 'H.'

D	H	D	H	D	H	D	H
0	00H	32	20H	64	40H	96	60H
1	01H	33	21H	65	41H	97	61H
2	02H	34	22H	66	42H	98	62H
3	03H	35	23H	67	43H	99	63H
4	04H	36	24H	68	44H	100	64H
5	05H	37	25H	69	45H	101	65H
6	06H	38	26H	70	46H	102	66H
7	07H	39	27H	71	47H	103	67H
8	08H	40	28H	72	48H	104	68H
9	09H	41	29H	73	49H	105	69H
10	0AH	42	2AH	74	4AH	106	6AH
11	0BH	43	2BH	75	4BH	107	6BH
12	0CH	44	2CH	76	4CH	108	6CH
13	0DH	45	2DH	77	4DH	109	6DH
14	0EH	46	2EH	78	4EH	110	6EH
15	0FH	47	2FH	79	4FH	111	6FH
16	10H	48	30H	80	50H	112	70H
17	11H	49	31H	81	51H	113	71H
18	12H	50	32H	82	52H	114	72H
19	13H	51	33H	83	53H	115	73H
20	14H	52	34H	84	54H	116	74H
21	15H	53	35H	85	55H	117	75H
22	16H	54	36H	86	56H	118	76H
23	17H	55	37H	87	57H	119	77H
24	18H	56	38H	88	58H	120	78H
25	19H	57	39H	89	59H	121	79H
26	1AH	58	3AH	90	5AH	122	7AH
27	1BH	59	3BH	91	5BH	123	7BH
28	1CH	60	3CH	92	5CH	124	7CH
29	1DH	61	3DH	93	5DH	125	7DH
30	1EH	62	3EH	94	5EH	126	7EH
31	1FH	63	3FH	95	5FH	127	7FH

D: decimal

H: hexadecimal

- * Decimal expressions such as used for MIDI channel, Bank Select, and Program Change will be the value 1 greater than the decimal value given in the above table.
- * Since each MIDI byte carries 7 significant data bits, each byte can express a maximum of 128 different values. Data for which higher resolution is required must be transmitted using two or more bytes. For example a value indicated as a two-byte value of aa bbH would have a value of $aa \times 128 + bb$.
- * For a signed number (+/-), 00H = -64, 40H = +/-, and 7FH = +63. I.e., the decimal equivalent will be 64 less than the decimal value given in the above table. For a two-byte signed number, 00 00H = -8192, 40 00H = +/-, and 7F 7FH = +8191. For example the decimal expression of aa bbH would be $aa \times 128 + bb - 64 \times 128$.
- * Hexadecimal notation in two 4-bit units is used for data indicated as "nibbled". The nibbled two-byte value of 0a 0b H would be $a \times 16 + b$.

<Example 1> What is the decimal equivalent of 5AH?

From the above table, 5AH = 90.

<Example 2> What is the decimal equivalent of the 7-bit hexadecimal values 12 34H?

From the above table, 12H = 18 and 34H = 52

Thus, $18 \times 128 + 52 = 2356$

<Example 3> What is the decimal equivalent of the nibbled expression 0A 03 09 0DH?

From the above table, 0AH = 10, 03H = 3, 09H = 9, 0DH = 13

Thus, the result is $((10 \times 16 + 3) \times 16 + 9) \times 16 + 13 = 41885$

<Example 4> What is the nibbled equivalent of the decimal number 1258?

16) 1258

16) 78 ...10

16) 4 ...14

0 ... 4

From the above table, 0=00H, 4=04H, 14=0EH, 10=0AH

Thus the result is 00 04 0E 0AH

■ ASCII code table

D	H	Char	D	H	Char	D	H	Char
32	20H	SP	64	40H	@	96	60H	`
33	21H	!	65	41H	A	97	61H	a
34	22H	"	66	42H	B	98	62H	b
35	23H	#	67	43H	C	99	63H	c
36	24H	\$	68	44H	D	100	64H	d
37	25H	%	69	45H	E	101	65H	e
38	26H	&	70	46H	F	102	66H	f
39	27H	'	71	47H	G	103	67H	g
40	28H	(72	48H	H	104	68H	h
41	29H)	73	49H	I	105	69H	i
42	2AH	*	74	4AH	J	106	6AH	j
43	2BH	+	75	4BH	K	107	6BH	k
44	2CH	,	76	4CH	L	108	6CH	l
45	2DH	-	77	4DH	M	109	6DH	m
46	2EH	.	78	4EH	N	110	6EH	n
47	2FH	/	79	4FH	O	111	6FH	o
48	30H	0	80	50H	P	112	70H	p
49	31H	1	81	51H	Q	113	71H	q
50	32H	2	82	52H	R	114	72H	r
51	33H	3	83	53H	S	115	73H	s
52	34H	4	84	54H	T	116	74H	t
53	35H	5	85	55H	U	117	75H	u
54	36H	6	86	56H	V	118	76H	v
55	37H	7	87	57H	W	119	77H	w
56	38H	8	88	58H	X	120	78H	x
57	39H	9	89	59H	Y	121	79H	y
58	3AH	:	90	5AH	Z	122	7AH	z
59	3BH	;	91	5BH	[123	7BH	{
60	3CH	<	92	5CH	¥	124	7CH	}
61	3DH	=	93	5DH]	125	7DH	~
62	3EH	>	94	5EH	^			
63	3FH	?	95	5FH	_			

D: decimal

H: hexadecimal

Note) SP indicates "space."

■ Examples of actual MIDI messages

<Example 1> 92 3E 5F

9n is the Note On status and 'n' is the MIDI channel number. Since 2H = 2, 3EH = 62, and 5FH = 95, this is a Note On message of MIDI CH = 3, note number 62 (note name D4) and velocity 95.

<Example 2> C9 49

CnH is the Program Change status and 'n' is the MIDI channel number. Since 9H = 9, and 49H = 73, this is a Program Change message of MIDI CH = 9, Program number 74.

<Example 3> EA 00 28

EnH is the Pitch Bend Change status and 'n' is the MIDI channel number. The 2nd byte (00H=0) is the LSB of the Pitch Bend value, and the 3rd byte (28H=40) is the MSB. However since the Pitch Bend is a signed number with 0 at 40 00H ($= 64 \times 128 + 0 = 8192$), the Pitch Bend value in this case is

$$28 \text{ 00H} - 40 \text{ 00H} = 40 \times 128 + 0 - (64 \times 128 + 0) = 5120 - 8192 = -3072$$

If we assume that the Pitch Bend Sensitivity is set to two semitones, the pitch will change only -200 cents for a Pitch Bend value of -8192 (00 00H). Thus, this message is specifying a Pitch Bend of $-200 \times (-3072) \div (-8192) = -75$ cents on MIDI CH = 11.

<Example 4> B3 64 00 65 00 06 0C 26 00 64 7F 65 7F

BnH is the Control Change status, and 'n' is the MIDI channel number. In Control Change messages, the 2nd byte is the controller number, and the 3rd byte is the parameter value. MIDI allows what is known as "running status," when if messages of the the same status follow each other, it is permitted to omit the second and following status bytes. In the message above, running status is being used, meaning that the message has the following content.

```

B3 64 00  MIDI CH = 4, RPN parameter number LSB: 00H
(B3) 65 00  MIDI CH = 4, RPN parameter number MSB: 00H
(B3) 06 0C  MIDI CH = 4, parameter value MSB: 0CH
(B3) 26 00  MIDI CH = 4, parameter value LSB: 00H
(B3) 64 7F  MIDI CH = 4, RPN parameter number LSB: 7FH
(B3) 65 7F  MIDI CH = 4, RPN parameter number MSB: 7FH
    
```

Thus, this message transmits a parameter value of 0C 00H to RPN parameter number 00 00H on MIDI CH = 4, and then sets the RPN parameter number to 7F 7FH.

The function assigned to RPN parameter number 00 00H is Pitch Bend Sensitivity, and the MSB of the parameter value indicates semitone steps. Since the MSB of this parameter value is 0CH = 12, the maximum width of pitch bend is being set to ± 12 semitones (1 octave).

Once the parameter number has been set for RPN or NRPN, all subsequent Data Entry messages on that channel will be effective. Thus, it is recommended that after you have

made the change you want, you set the parameter number to 7F 7FH (an "unset" or "null" setting). The final (B3) 64 7F (B3) 65 7F is for this purpose.

It is not a good idea to store many events within the data of a song (e.g., a Standard MIDI File song) using running status as shown in <Example 4>. When the song is paused, fast-forwarded or rewound, the sequencer may not be able to transmit the proper status, causing the sound source to misinterpret the data. It is best to attach the proper status byte to all events.

It is also important to transmit RPN or NRPN parameter number settings and parameter values in the correct order. In some sequencers, data events recorded in the same clock (or a nearby clock) can sometimes be transmitted in an order other than the order in which they were recorded. It is best to record such events at an appropriate interval (1 tick at TPQN=96, or 5 ticks at TPQN=480).

* TPQN : Ticks Per Quarter Note (i.e., the time resolution of the sequencer)

■ Examples of system exclusive messages and calculating the checksum

Roland exclusive messages (RQ1, DT1) are transmitted with a checksum at the end of the data (before F7) to check that the data was received correctly. The value of the checksum is determined by the address and data (or size) of the exclusive message.

● How to calculate the checksum

The checksum consists of a value whose lower 7 bits are 0 when the address, size and checksum itself are added.

The following formula shows how to calculate the checksum when the exclusive message to be transmitted has an address of aa bb cc ddH, and data or size of ee ffH.

$$\begin{aligned} aa + bb + cc + dd + ee + ff &= \text{total} \\ \text{total} \text{ \AA} 128 &= \text{quotient} \dots \text{remainder} \\ 128 - \text{remainder} &= \text{checksum} \end{aligned}$$

<Example 1> Setting the REVERB TYPE to HALL2 (DT1)

Referring to "3. Parameter address map," the starting address for Part Information is 01 00 00 00H, and offset address of Part Information Common is 00 00H, and the REVERB TYPE address is 00 28H. Therefore, the address will be

$$\begin{array}{r} 01\ 00\ 00\ 00\text{H} \\ +) \quad 00\ 00\text{H} \\ \quad 00\ 28\text{H} \\ \hline 01\ 00\ 00\ 28\text{H} \end{array}$$

Since HALL2 is parameter value 05H,

F0 41 10 00H 0BH 12 01 00 00 28 05 ?? F7
(1) (2) (3) (4) (5) (6) address data checksum (7)

(1) Exclusive status (2) ID number (Roland) (3) device ID (17)
(4), (5) model ID (MC-505) (6) command ID (DT1) (7) EOX

Next we calculate the checksum.

$$\begin{aligned} 01\text{H} + 00\text{H} + 00\text{H} + 28\text{H} + 05\text{H} &= 1 + 0 + 0 + 40 + 5 = 46(\text{sum}) \\ 46(\text{total}) / 128 &= 0(\text{quotient}) \dots 46(\text{remainder}) \\ \text{checksum} &= 128 - 46(\text{quotient}) = 82 = 52\text{H} \end{aligned}$$

This means that the message transmitted will be F0 41 10 00 0B 12 01 00 00 28 05 52 F7.

<Example 2> Obtaining part information data (RQ1)

Referring to "3. Parameter address map," the starting addresses for Part Information are assigned as follows.

01 00 00 00H Part Info Common
01 00 10 00H Part Info Part 1
01 00 11 00H Part Info Part 2

01 00 16 00H Part Info Part 7
01 00 19 00H Part Info Part 10

Since the size of Part Information Part is 00 00 00 1AH, this size is added to the starting address of Part Information Part 16, to obtain

$$\begin{array}{r} 01\ 00\ 1F\ 00\text{H} \\ +) \quad 00\ 00\ 00\ 1A\text{H} \\ \quad 01\ 00\ 1F\ 1A\text{H} \end{array}$$

Therefore, the size of the data to be obtained is

$$\begin{array}{r} 01\ 00\ 1F\ 1A\text{H} \\ -) \quad 01\ 00\ 00\ 00\text{H} \\ \quad 00\ 00\ 1F\ 1A\text{H} \end{array}$$

F0 41 10 00 0B 11 01 00 00 00 00 00 1F 1A ?? F7
(1) (2) (3) (4) (5) (6) address data checksum (7)

(1) Exclusive status (2) ID number (Roland) (3) Device ID (17)
(4), (5) Model ID (MC-505) (6) Command ID (RQ1) (7) EOX

When the checksum is calculated in the same way as in <Example 2>, we have the following message to be transmitted: F0 41 10 00 0B 11 01 00 00 00 00 00 1F 1A 46 F7.

● Scale Tune function (Model ID : 42H (GS), address: 40 1x 40H)

Scale Tune is a function that makes fine adjustments to the pitch of each note C-B. Settings are made for one octave, and applied to the notes of all octaves. By making Scale Tune settings you can use tunings and temperaments other than the standard Equal Temperament. Here we give three types of settings as examples.

○ Equal temperament

This temperament divides the octave into 12 equal steps, and is the temperament most frequently used today, especially in western music. Initially, the Scale Tune function of this instrument is set to Equal Temperament.

○ Just intonation (tonic of C)

The primary triads sound more beautiful in just intonation than in equal temperament. However, this applies only in one key, and chords will be discordant if you play in a different key. The settings here are for a tonic of C.

○ Arabian-type scale

The Scale Tune function allow you to use various tunings of ethnic music. Here is one of the Arabian scales.

Setting examples

Note	Equal Temp.	Just (in C)	Arabian-type scale
C	0	0	-6
C#	0	-8	+45
D	0	+4	-2
Eb	0	+16	-12
E	0	-14	-51
F	0	-2	-8
F#	0	-10	+43
G	0	+2	-4
G#	0	+14	+47
A	0	-16	0
Bb	0	+14	-10
B	0	-12	-49

The values in the above table are in units of 1 cent. Convert these values to hexadecimal, and transmit them as exclusive data. For example to set the Scale Tune of Part 1 to an Arabian-type scale, transmit the following data.

F0 41 10 42 12 40 11 40 3A 6D 3E 34 0D 38 6B 3C 6F 40 36 0F 50 F7

MIDI Implementation Chart

Function...	Transmitted	Recognized	Remarks
Basic Channel Default <input type="checkbox"/> Changed	1-7, 10 <input type="checkbox"/> X	1-7, 10 <input type="checkbox"/> X	There is no basic channel.
Mode Default <input type="checkbox"/> Messages <input type="checkbox"/> Altered	Mode 3 <input type="checkbox"/> <input type="checkbox"/> OMNI OFF, POLY <input type="checkbox"/> * 2 *****	X <input type="checkbox"/> X	<input type="checkbox"/> <input type="checkbox"/>
Note Number : <input type="checkbox"/> True Voice	0-127 <input type="checkbox"/> *****	0-127 <input type="checkbox"/> 0-127	
Velocity Note ON <input type="checkbox"/> Note OFF	O <input type="checkbox"/> O	O <input type="checkbox"/> O	
After Touch Key's <input type="checkbox"/> Ch's	O <input type="checkbox"/> O	O <input type="checkbox"/> * 1 <input type="checkbox"/> O * 1	
Pitch Bend	O	O * 1	
Control Change 0-119	O * 1 <input type="checkbox"/> <input type="checkbox"/>	O * 1 <input type="checkbox"/> <input type="checkbox"/>	
Prog Change <input type="checkbox"/> : True #	O <input type="checkbox"/> * 1 *****	O <input type="checkbox"/> * 1 0-127	<input type="checkbox"/> <input type="checkbox"/>
System Exclusive	O	O * 1	
System Common : Song Pos <input type="checkbox"/> : Song Sel <input type="checkbox"/> : Tune	O <input type="checkbox"/> X <input type="checkbox"/> X	O <input type="checkbox"/> * 3 X <input type="checkbox"/> X	
System Real Time : Clock <input type="checkbox"/> : Commands	O <input type="checkbox"/> O	O <input type="checkbox"/> * 4 <input type="checkbox"/> O * 3	
Aux Message : All sound off <input type="checkbox"/> : Reset all controllers <input type="checkbox"/> : Local ON/OFF <input type="checkbox"/> : All Notes OFF <input type="checkbox"/> : Active Sense <input type="checkbox"/> : Reset	O <input type="checkbox"/> <input type="checkbox"/> O <input type="checkbox"/> <input type="checkbox"/> X <input type="checkbox"/> * 5 <input type="checkbox"/> O <input type="checkbox"/> * 6 <input type="checkbox"/> X <input type="checkbox"/> * 7 <input type="checkbox"/> X	O <input type="checkbox"/> <input type="checkbox"/> O <input type="checkbox"/> <input type="checkbox"/> X <input type="checkbox"/> <input type="checkbox"/> O (123-127) <input type="checkbox"/> * 6 <input type="checkbox"/> O <input type="checkbox"/> * 7 <input type="checkbox"/> X	<input type="checkbox"/> <input type="checkbox"/> <input type="checkbox"/> <input type="checkbox"/> <input type="checkbox"/> <input type="checkbox"/> <input type="checkbox"/> <input type="checkbox"/> <input type="checkbox"/> <input type="checkbox"/>
Notes	* 1 O X is selectable <input type="checkbox"/> * 2 Omni Off, Poly is transmitted to all channels at start-up. <input type="checkbox"/> * 3 When Sync Mode is SLAVE or REMOTE <input type="checkbox"/> * 4 When Sync Mode is SLAVE <input type="checkbox"/> * 5 Not stored/transmitted even if received, but can be created in the Microscope and transmitted. <input type="checkbox"/> * 6 Mode messages (123-127) are stored/transmitted after All Note Off processing is performed. The All Note Off message itself is not stored/transmitted, but can be created in the Microscope and transmitted. <input type="checkbox"/> * 7 Transmitted/received by the sound source section. The sequencer section will perform the action taken reception is interrupted.		

Mode 1 : OMNI ON, POLY
 Mode 3 : OMNI OFF, POLY

Mode 2 : OMNI ON, MONO
 Mode 4 : OMNI OFF, MONO

O : Yes
 X : No

Main Specifications

MC-505: GROOVEBOX

● **Parts: 24 Parts (Main: 8 + RPS: 16)**

● **Maximum Polyphony: 64 voices**

● **Patches**

Preset: 512
User: 256
Card: 512

● **Rhythm Set**

Preset: 26
User: 20
Card: 20

● **Effects**

Reverb
Delay
EFX (24 types)

● **Sequencer**

Tracks: 8 + Mute Ctrl Track
Resolution: 96 ticks per quarter note
Tempo: 20.0–240.0 (Maximum)
Songs: 50

Patterns

Preset: 248
RPS: 466
User: 200 (Maximum)
Card: 200 (Maximum)

Maximum Note Storage

Internal: approx. 95,000 Note
Card (Option: 2M Byte): approx. 220,000 Note
Card (Option: 4M Byte): approx. 480,000 Note

Quantize

Grid
Groove (71 types)
Shuffle

Arpeggiator: 53 Style

RPS Set: 60

Pattern Set: 30

● **DBeam Controller: 28 Types**

● **Display**

LCD : 16 characters, 2 lines
7 Segment LED: 6 characters
Beat LED

● **Connectors**

Mix Output Jack (L (MONO), R)
Direct Output Jack 1 (L (MONO), R)
Direct Output Jack 2 (L (MONO), R)
Headphone Jack
MIDI Connectors (IN, OUT)
Foot Control Jack
Memory Card Slot
AC Inlet

● **Power Supply**

AC117V, AC230V, AC240V

● **Power Consumption**

12W (AC117V), 14W (AC230V), 14W (AC240V)

● **Dimensions**

462 (W) x 320 (D) x 110 (H) mm
18-3/16 x 12-5/8 x 4-3/8 inches

● **Weight**

5 kg / 11 lbs 1 oz

● **Accessories**

Quick Start
Owner's Manual
AC Cord
Card Protector

● **Options**

SmartMedia: S2M-5/S4M-5

** In the interest of product improvement, the specifications and/or appearance of this unit are subject to change without prior notice.*

Index

“Q” represents the Quick Start.

- 4 band EQ.....87
- accent rate.....106, 108
- adlib1125
- adlib2126
- aftertouch59
- all mute21, 125
- alternate pan depth.....48, 73
- amplifier45, 72
- amplifier depth.....54
- amplifier envelope48, 74
- amplifier envelope level 1–3.....50, 75
- amplifier envelope time 1–449, 75
- amplifier envelope time keyfollow.....50
- amplifier envelope velocity sensitivity49, 75
- amplifier envelope velocity time1 sensitivity50
- amplifier envelope velocity time4 sensitivity50
- arpeggiator.....Q34, 105, 129
- arpeggio.....105, 173
- arpeggio control channel169
- arpeggio range.....125
- arpeggio style106, 107
- arpeggio sync.....167
- arpeggio write108
- auto checksum.....167
- auto pan.....101
- backup delete.....161
- backup load.....160
- band pass filter40, 68
- bank select.....172
- beam assign1165
- beam assign2.....165
- beam assign3.....165
- beam polarity.....165
- beam range lower.....165
- beam range upper.....165
- beat128
- beat pattern108
- bend range.....60, 75
- bend range down.....60
- bend range up.....60
- bias direction.....46
- bias level.....47
- bias point.....47
- booster56
- booster gain.....56
- BPM.....20
- bulk dump.....177
- card duplicate161
- card memory.....145
- category jump.....Q11
- change event142
- change gate time.....151
- change velocity150
- channel aftertouch.....141
- checksum.....142
- chord135
- chorus.....96
- coarse tune36, 64
- common.....54
- compressor.....93
- control change141
- control destination1/2/3/4.....60
- control1/2/3/4 depth60
- copy146
- count in128
- cross drum pan.....124
- cross pan.....124
- current part23
- cutoff + resonance 1 all.....122
- cutoff + resonance 1 single.....122
- cutoff + resonance 2 all.....122
- cutoff + resonance 2 single.....123
- cutoff + resonance 3 all.....123
- cutoff + resonance 3 single.....123
- cutoff frequencyQ22, 40, 42, 68, 69
- cutoff frequency key follow.....42
- data thin.....152
- DBeam ControllerQ38, 121
- delay.....Q28, 82
- delay level84, 85, 124
- delay output assign.....85
- delay start.....50
- delay time.....53, 83, 85
- delay type.....82, 85
- delete event.....143
- delete measure.....148
- delete pattern.....158
- detune effect.....36
- device ID number.....168
- distortion90
- edit TxRx mode169
- EFX.....Q30, 86
- EFX control 1.....124
- EFX control 2.....125
- EFX control 3.....125
- EFX->delay level84, 85
- EFX->reverb level.....81, 82
- enhancer89
- envelope mode64
- erase147
- factory presetQ5
- fade mode.....53
- fade time53
- fast-forward20, 154
- feedback level83, 85
- feedback pitch shifter102
- filter40

filter depth.....	54	memory.....	16
filter envelope.....	43, 70	memory card.....	17, 159
filter envelope depth.....	43, 44, 71	memory information	144
filter envelope level 1-4.....	45, 71	metronome	128
filter envelope time 1-4.....	45, 71	metronome level.....	166
filter envelope time keyfollow	45	micro edit	140
filter envelope velocity curve.....	44	micro scope	140
filter envelope velocity sensitivity.....	44, 71	MIDI.....	168, 171
filter envelope velocity time sensitivity.....	71	MIDI channel	26, 171
filter envelope velocity time1 sensitivity.....	45	MIDI Rx switch.....	169
filter envelope velocity time4 sensitivity.....	45	MIDI update	30
filter type	40, 42, 68	modify data.....	30, 130
fine tune.....	36, 65	modulation all	121
flanger.....	98	modulation lever	59
frequency cross modulation	35	modulation single	122
FXM.....	35	monitor	21
FXM color.....	35	motif.....	107
FXM depth	35	move event.....	143
gate reverb.....	103	mute	Q12, 21, 131, 141
gate time	134	mute exchange.....	21
gate time ratio.....	134, 137	mute group.....	64
grid quantize.....	113	no event	142
groove quantize.....	115	noise generator	91
HF damp(delay)	85	note.....	141
HF damp(reverb)	80, 82	note + pitch bend	125
high pass filter	40, 68	OCTAVE	Q9
hold	105, 109	octave range.....	106, 108
input quantize.....	128	octave shift.....	Q20, 23
insert event.....	143	overdrive	89
insert measure	149	pad velocity.....	165
insert pattern.....	158	pan depth	54
key range lower	56	pan key follow	47
key range upper	56	part.....	15
key shift all.....	124	part delay level	84
key shift single.....	124	part EFX/output assign	104
key sync	53	part key shift	25
LCD contrast.....	164	part level.....	24
level offset	53	part mixer.....	Q14, 24, 130
LFO.....	50	part mute	21
LFO1.....	Q24, 52-54	part pan	24
LFO1 amplifier depth.....	52	part pan all	123
LFO1 depth	51	part pan single	124
LFO1 filter depth.....	52	part reverb level	80
LFO1 pitch depth	51	part slider	24
LFO1 rate	51	patch.....	Q18, 14
LFO1 waveform.....	50	patch edit.....	33
limiter.....	93	patch initialize	62
Lo-Fi.....	90	patch remain	164
local Tx switch.....	169	patch tone copy	62
loop mode	166	patch write	61
loop rest	128, 131	pattern.....	Q10, 16, 19
low boost	Q9	pattern initialize	27
low pass filter.....	40, 68	pattern length	128
master tune	163	pattern set.....	31
MEGAMIX	Q33, 119	pattern set write	32

pattern write	26	rewind.....	20, 154
peaking filter.....	40, 68	rhythm edit	63
pedal assign	165	rhythm key copy	78
pedal polarity.....	165	rhythm mute	21
phaser.....	95	rhythm set	Q20, 15
phonograph.....	92	rhythm set write.....	77
pitch.....	36, 64	rhythm tone delay level	76
pitch bend.....	59, 75, 141	rhythm tone EFX/output assign.....	76
pitch bend all	122	rhythm tone initialize	78
pitch bend lever.....	59	rhythm tone level.....	72
pitch bend single	122	rhythm tone pan.....	72
pitch depth	54	rhythm tone reverb level.....	76
pitch envelope	37, 66	rhythm tone switch.....	64
pitch envelope depth.....	38, 66	ring modulator	56
pitch envelope level 1-4.....	39, 67	RPS	Q36, 109, 172
pitch envelope time 1-4	39, 67	RPS control channel.....	169
pitch envelope time keyfollow	39	RPS EFX output assign.....	111
pitch envelope velocity sensitivity	38, 67	RPS part delay level.....	111
pitch envelope velocity time sensitivity	67	RPS part key shift.....	111
pitch envelope velocity time1 sensitivity	39	RPS part level.....	111
pitch envelope velocity time4 sensitivity	39	RPS part pan	111
pitch keyfollow	37	RPS part reverb level	111
play quantize	Q16, 113	RPS set write	112
polyphonic aftertouch	141	RPS trigger quantize	167
portamento.....	57	scale tune	163
portamento mode.....	59	scale(adlib)	126
portamento start pitch.....	59	scale(recording)	136
portamento switch	57, 59	sequencer.....	16, 166
portamento time.....	58, 59	sequencer output assign.....	25
portamento type.....	59	setup copy	27
preset memory.....	16	shift clock.....	151
program change	141, 172	short delay.....	100
radio tuning	92	shuffle quantize	114
random pan switch	46, 72	shuffle rate.....	108, 115
random pitch depth.....	36, 65	slicer	94
rate.....	52	slide effect.....	136, 139
real-time erase	132	solo legate switch	58
real-time modify.....	28	solo switch.....	58
real-time recording	127	song.....	Q58, 16, 154
real-time transpose	Q17, 22	song copy	157
Receive Bank Select Switch.....	170	song initialize.....	158
Receive Program Change Switch.....	170	song write.....	155
Receive System Exclusive Switch.....	170	space-D	97
recording parameter	128	spectrum	88
recording part.....	128, 129, 133	staccato	134
remote keyboard switch.....	168	standard tempo	20
resolution.....	113, 114	start/stop.....	125
resonance.....	Q23, 41, 42, 69	step flanger.....	99
resonance limiter	164	step recording	133
resonance velocity sens	42, 69	step recording1	134
rest.....	135	step recording2.....	136
reverb.....	Q26, 79, 103	step time	134
reverb level.....	80, 82, 124	strength.....	114, 117
reverb time	80, 82	stretch tune depth	56
reverb type	79, 82	stretch tuning.....	56

structure type.....	54
sync mode	166
sync out.....	166
system exclusive.....	142
system memory	16
tap resolution.....	167
tap switch	167
tap tempo	20
template	115
tempo	20, 131
tempo change.....	141
tempo sync	53
temporary	17, 145
tenuto	134
tetra chorus	97
thru.....	168
tie	135
tone.....	14
tone level	45
tone pan.....	46
tone switch	35
transmit active sensing switch	170
transmit bank select switch	170
transmit program change switch.....	170
transpose	150
tremolo.....	95
tuning.....	163
turntable	125
undo/redo.....	18, 127, 146
user backup.....	160
user memory	16, 145
velocity	134, 137
velocity cross fade.....	57
velocity range lower	57
velocity range switch.....	57
velocity range upper.....	57
velocity strength.....	117
view filter	144
voice priority.....	56
voice reserve	164
wave gain	35, 64
wave select	34, 35, 63, 64
waveform	34, 52, 63

Information

When you need repair service, call your nearest Roland Service Center or authorized Roland distributor in your country as shown below.

ARGENTINA

Instrumentos Musicales S.A. □
Florida 638 □
(1005) Buenos Aires
ARGENTINA □
TEL: (01) 394 4029 □

BRAZIL

Roland Brasil Ltda. □
R. Coronel Octaviano da Silveira
203 05522-010 □
Sao Paulo BRAZIL □
TEL: (011) 843 9377 □

CANADA

Roland Canada Music Ltd. □
(Head Office) □
5480 Parkwood Way Richmond
B. C., V6V 2M4 CANADA □
TEL: (0604) 270 6626 □

Roland Canada Music Ltd. □
(Toronto Office) □
Unit 2, 109 Woodbine Downs
Blvd, Etobicoke, ON □
M9W 6Y1 CANADA □
TEL: (0416) 213 9707 □

MEXICO

Casa Veerkamp, s.a. de c.v. □
Av. Toluca No. 323 Col. Olivar de
los Padres 01780 Mexico D.F.
MEXICO □
TEL: (525) 668 04 80 □

**La Casa Wagner de
Guadalajara s.a. de c.v.** □
Av. Corona No. 202 S.J.
Guadalajara, Jalisco Mexico
C.P.44100 MEXICO □
TEL: (03) 613 1414

PANAMA

Productos Superiores, S.A. □
Apartado 655 - Panama 1 □
REP. DE PANAMA □
TEL: 26 3322

U. S. A.

Roland Corporation U.S. □
7200 Dominion Circle □
Los Angeles, CA. 90040-3696, □
U. S. A. □
TEL: (0213) 685 5141

VENEZUELA

Musicland Digital C.A. □
Av. Francisco de Miranda, □
Centro Parque de Cristal, Nivel
C2 Local 20 Caracas □
VENEZUELA □
TEL: (02) 285 9218

AUSTRALIA

**Roland Corporation
Australia Pty. Ltd.** □
38 Campbell Avenue □
Dee Why West. NSW 2099
AUSTRALIA □
TEL: (02) 9982 8266

NEW ZEALAND

Roland Corporation (NZ) Ltd. □
97 Mt. Eden Road, Mt. Eden,
Auckland 3, NEW ZEALAND □
TEL: (09) 3098 715

CHINA

**Beijing Xinghai Musical
Instruments Co., Ltd.** □
6 Huangmichang Chao Yang
District, Beijing, CHINA □
TEL: (010) 6774 7491

HONG KONG

**Tom Lee Music Co., Ltd.
Service Division** □
22-32 Pun Shan Street, Tsuen
Wan, New Territories, □
HONG KONG □
TEL: 2415 0911

INDONESIA

PT Galestra Inti □
Kompleks Perkantoran □
Duta Merlin Blok E No.6—7 □
Jl. Gajah Mada No.3—5, □
Jakarta 10130, □
INDONESIA □
TEL: (021) 6335416

KOREA

**Cosmos Corporation
Service Station** □
261 2nd Floor Nak-Won Arcade
Jong-Ro ku, Seoul, KOREA □
TEL: (02) 742 8844 □

MALAYSIA

Bentley Music SDN BHD □
140 & 142, Jalan Bukit Bintang
55100 Kuala Lumpur, MALAYSIA □
TEL: (03) 2443333

PHILIPPINES

G.A. Yupangco & Co. Inc. □
339 Gil J. Puyat Avenue □
Makati, Metro Manila 1200, □
PHILIPPINES □
TEL: (02) 899 9801

SINGAPORE

Swee Lee Company □
BLOCK 231, Bain Street #03-23 □
Bras Basah Complex, □
SINGAPORE 180231 □
TEL: 3367886 □

**CRISTOFORI MUSIC PTE
LTD** □
Blk 3014, Bedok Industrial Park E,
#02-2148, SINGAPORE 489980 □
TEL: 243 9555

TAIWAN

**ROLAND TAIWAN
ENTERPRISE CO., LTD.** □
Room 5, 9fl. No. 112 Chung Shan
N.Road Sec.2, Taipei, TAIWAN,
R.O.C. □
TEL: (02) 561 3339

THAILAND

Theera Music Co., Ltd. □
330 Verng Nakorn Kasem, Soi 2,
Bangkok 10100, THAILAND □
TEL: (02) 2248821

VIETNAM

Saigon music distributor □
160 Nguyen Dinh Chieu St. Dist 3
Ho chi minh City □
VIETNAM □
TEL: 88-242531

BAHRAIN

Moon Stores □
Bad Al Bahrain Road, □
P.O.Box 20077 □
State of BAHRAIN □
TEL: 211 005

ISRAEL

**Halilit P. Greenspoon &
Sons Ltd.** □
8 Retzif Fa'aliya Hashnya St. □
Tel-Aviv-Yaho ISRAEL □
TEL: (03) 6823666

JORDAN

AMMAN Trading Agency □
Prince Mohammed St. P. O. Box
825 Amman 11118 JORDAN □
TEL: (06) 641200

KUWAIT

Easa Husain Al-Yousifi □
P.O. Box 126 Safat 13002 □
KUWAIT □
TEL: 5719499

LEBANON

A. Chahine & Fils □
P.O. Box 16-5857 Gergi Zeidan St.
Chahine Building, Achrafieh □
Beirut, LEBANON □
TEL: (01) 335799

OMAN

**OHI Electronics & Trading
Co. LLC** □
P. O. Box 889 Muscat □
Sultanate of OMAN □
TEL: 959085

QATAR

Badie Studio & Stores □
P.O.Box 62, □
DOHA QATAR □
TEL: 423554

SAUDI ARABIA

Abdul Latif S. Al-Ghamdi □
Trading Establishment □
Middle East Commercial Center
Al-Khobar Dharan Highway
W/hamood st. □
P. O. Box 3631 Al-Khober □
31952 SAUDIARABIA □
TEL: (03) 898 2332

SYRIA

**Technical Light & Sound
Center** □
Khaled Ibn Al Walid St. □
P.O.Box 13520 □
Damascus - SYRIA □
TEL: (011) 2235 384

TURKEY

Barkat Sanayi ve Ticaret □
Siraselvier Cad. Guney Ishani No.
86/6 Taksim, Istanbul TURKEY □
TEL: (0212) 2499324

U. A. E

**Zak Electronics & Musical
Instruments Co.** □
Zabeel Road, Al Sherooq Bldg.,
No. 14, Grand Floor DUBAI
U.A.E. □
P.O. Box 8050 DUBAI, U.A.E □
TEL: (04) 360715

EGYPT

Al Fanny Trading Office □
9, Ebn Hagar El Askalany Street,
Ard El Golf, Heliopolis, Cairo,
11341 EGYPT □
TEL: (02) 4171828 □
(02) 4185531 □

KENYA

Musik Land Limited □
P.O Box 12183 Moi Avenue
Nairobi Republic of KENYA □
TEL: (2) 338 346

REUNION

Maison FO - YAM Marcel □
25 Rue Jules Merman ZL
Chaudron - BP79 97491 □
Ste Clotilde REUNION □
TEL: 28 29 16

SOUTH AFRICA

**That Other Music Shop
(PTY) Ltd.** □
11 Melle Street (Cnr Melle and
Juta Street) □
Braamfontein 2001 □
Republic of SOUTH AFRICA □
TEL: (011) 403 4105 □

Paul Bothner (PTY) Ltd. □
17 Werdmuller Centre Claremont
7700 □
Republic of SOUTH AFRICA □
TEL: (021) 64 4030 □

AUSTRIA

E. Dematte & Co. □
Neu-Rum Siemens-Strasse 4 □
6063 Innsbruck AUSTRIA □
TEL: (0512) 26 44 260

BELGIUM/HOLLAND/ LUXEMBOURG

Roland Benelux N. V. □
Houtstraat 1 B-2260 Oevel-
Westerlo BELGIUM □
TEL: (014) 575811

BELORUSSIA

TUSHE □
UL. Rabkorovskaya 17 □
220001 MINSK □
TEL: (0172) 764-911

CYPRUS

Radex Sound Equipment Ltd. □
17 Diagorou St., P.O.Box 2046,
Nicosia CYPRUS □
TEL: (02) 453 426

DENMARK

Roland Scandinavia A/S □
Langebrogade 6 Post Box 1937
DK-1023 Copenhagen K.
DENMARK □
TEL: 32 95 3111

FRANCE

MUSIKENGRO □
Zac de Folliouses 01706 □
Les Echets Miribel FRANCE □
TEL: 472 26 2700

FINLAND

**Roland Scandinavia As,
Filiat Finland** □
Lauttaasaarentie 54 B □
Fin-00201 Helsinki, FINLAND □
TEL: (9) 682 4020

GERMANY

**Roland Elektronische
Musikinstrumente
Handelsgesellschaft mbH.** □
Oststrasse 96, 22844 Norderstedt,
GERMANY □
TEL: (040) 52 60090

GREECE

V. Dimitriadis & Co. Ltd. □
20, Alexandras St. & Bouboulinas
54 St. 106 82 Athens, GREECE □
TEL: (01) 8232415

HUNGARY

Intermusica Ltd. □
Warehouse Area 'DEPO' Pf.83 □
H-2046 Torokbalint, HUNGARY □
TEL: (23) 511011

IRELAND

**The Dublin Service Centre
Audio Maintenance Limited** □
11 Brunswick Place Dublin 2
Republic of IRELAND □
TEL: (01) 677322

ITALY

Roland Italy S. p. A. □
Viale delle Industrie, 8 □
20020 Arese Milano, ITALY □
TEL: (02) 93581311

NORWAY

**Roland Scandinavia Avd.
Kontor Norge** □
Lilleakerveien 2 Postboks 95
Lilleaker N-0216 Oslo □
NORWAY □
TEL: 273 0074 □

POLAND

P. P. H. Brzostowicz Marian □
UL. Blokowa 32, 03624 Warszawa
POLAND □
TEL: (022) 679 44 19

PORTUGAL

**Caius - Tecnologias Audio e
Musica, Lda.** □
Rue de SANTA Catarina 131 □
4000 Porto, PORTUGAL □
TEL: (02) 38 4456

RUSSIA

Slami Music Company □
Sadojava-Triumfal'naja st., 16
103006 Moscow, RUSSIA □
TEL: 095 209 2193 □

SPAIN

Roland Electronics □
de España, S. A. □
Calle Bolivia 239 08020 Barcelona,
SPAIN □
TEL: (93) 308 1000

SWEDEN

**Roland Scandinavia A/S
SWEDISH SALES OFFICE** □
Danvik Center 28, 2 tr. □
S-131 30 Nacka SWEDEN □
TEL: (08) 702 0020

SWITZERLAND

Roland (Switzerland) AG □
Musitronic AG □
Gerberstrasse 5, CH-4410 Liestal,
SWITZERLAND □
TEL: (061) 921 1615

UKRAINE

TIC-TAC □
Mira Str. 19/108 □
P.O.Box 180 □
295400 Munkachevo, UKRAINE □
TEL: (03131) 414-40

UNITED KINGDOM

**Roland (U.K.) Ltd., Swansea
Office** □
Atlantic Close, Swansea
Enterprise Park SWANSEA □
West Glamorgan SA7 9FJ,
UNITED KINGDOM □
TEL: (01792) 700139 □



This product complies with the requirements of European Directives EMC 89/336/EEC and LVD 73/23/EEC.

For EU Countries

FEDERAL COMMUNICATIONS COMMISSION RADIO FREQUENCY INTERFERENCE STATEMENT

This equipment has been tested and found to comply with the limits for a Class B digital device, pursuant to Part 15 of the FCC Rules. These limits are designed to provide reasonable protection against harmful interference in a residential installation. This equipment generates, uses, and can radiate radio frequency energy and, if not installed and used in accordance with the instructions, may cause harmful interference to radio communications. However, there is no guarantee that interference will not occur in a particular installation. If this equipment does cause harmful interference to radio or television reception, which can be determined by turning the equipment off and on, the user is encouraged to try to correct the interference by one or more of the following measures:

- Reorient or relocate the receiving antenna.
- Increase the separation between the equipment and receiver.
- Connect the equipment into an outlet on a circuit different from that to which the receiver is connected.
- Consult the dealer or an experienced radio/TV technician for help.

Unauthorized changes or modification to this system can void the users authority to operate this equipment. This equipment requires shielded interface cables in order to meet FCC class B Limit.

For the USA

NOTICE

This Class B digital apparatus meets all requirements of the Canadian Interference-Causing Equipment Regulations.

AVIS

Cet appareil numérique de la classe B respecte toutes les exigences du Règlement sur le matériel brouilleur du Canada.

For Canada